

Displacement Sensor

ZW series

Confocal Fiber Type Displacement Sensor

User's Manual

ZW-C1□ T



Introduction

Thank you for purchasing the ZW.

This manual provides information regarding functions, performance and operating methods that are required for using the ZW.

When using the ZW, be sure to observe the following:

- The ZW must be operated by personnel knowledgeable in electrical engineering.
- To ensure correct use, please read this manual thoroughly to deepen your understanding of the product.
- Please keep this manual in a safe place so that it can be referred to whenever necessary.

User's Manual

APPLICATION CONSIDERATIONS
(Please Read)

Basic configuration

1

Installation and Connections

2

Basic Operation

3

Settings for Function

4

Convenient Functions

5

Communications with External Devices

6

Offline Settings

7

Troubleshooting

8

Sensor controller operations

9

APPENDICES

10

Confocal Fiber Type
Displacement Sensor

ZW

READ AND UNDERSTAND THIS DOCUMENT

Please read and understand this document before using the products. Please consult your OMRON representative if you have any questions or comments.

WARRANTY

OMRON's exclusive warranty is that the products are free from defects in materials and workmanship for a period of one year (or other period if specified) from date of sale by OMRON.

OMRON MAKES NO WARRANTY OR REPRESENTATION, EXPRESS OR IMPLIED, REGARDING NON-INFRINGEMENT, MERCHANTABILITY, OR FITNESS FOR PARTICULAR PURPOSE OF THE PRODUCTS. ANY BUYER OR USER ACKNOWLEDGES THAT THE BUYER OR USER ALONE HAS DETERMINED THAT THE PRODUCTS WILL SUITABLY MEET THE REQUIREMENTS OF THEIR INTENDED USE. OMRON DISCLAIMS ALL OTHER WARRANTIES, EXPRESS OR IMPLIED.

LIMITATIONS OF LIABILITY

OMRON SHALL NOT BE RESPONSIBLE FOR SPECIAL, INDIRECT, OR CONSEQUENTIAL DAMAGES, LOSS OF PROFITS OR COMMERCIAL LOSS IN ANY WAY CONNECTED WITH THE PRODUCTS, WHETHER SUCH CLAIM IS BASED ON CONTRACT, WARRANTY, NEGLIGENCE, OR STRICT LIABILITY.

In no event shall responsibility of OMRON for any act exceed the individual price of the product on which liability is asserted.

IN NO EVENT SHALL OMRON BE RESPONSIBLE FOR WARRANTY, REPAIR, OR OTHER CLAIMS REGARDING THE PRODUCTS UNLESS OMRON'S ANALYSIS CONFIRMS THAT THE PRODUCTS WERE PROPERLY HANDLED, STORED, INSTALLED, AND MAINTAINED AND NOT SUBJECT TO CONTAMINATION, ABUSE, MISUSE, OR INAPPROPRIATE MODIFICATION OR REPAIR.

SUITABILITY FOR USE

THE PRODUCTS CONTAINED IN THIS DOCUMENT ARE NOT SAFETY RATED. THEY ARE NOT DESIGNED OR RATED FOR ENSURING SAFETY OF PERSONS, AND SHOULD NOT BE RELIED UPON AS A SAFETY COMPONENT OR PROTECTIVE DEVICE FOR SUCH PURPOSES.

Please refer to separate catalogs for OMRON's safety rated products.

OMRON shall not be responsible for conformity with any standards, codes, or regulations that apply to the combination of products in the customer's application or use of the product.

At the customer's request, OMRON will provide applicable third party certification documents identifying ratings and limitations of use that apply to the products. This information by itself is not sufficient for a complete determination of the suitability of the products in combination with the end product, machine, system, or other application or use.

The following are some examples of applications for which particular attention must be given. This is not intended to be an exhaustive list of all possible uses of the products, nor is it intended to imply that the uses listed may be suitable for the products:

- Outdoor use, uses involving potential chemical contamination or electrical interference, or conditions or uses not described in this document.

- Nuclear energy control systems, combustion systems, railroad systems, aviation systems, medical equipment, amusement machines, vehicles, safety equipment, and installations subject to separate industry or government regulations.
- Systems, machines, and equipment that could present a risk to life or property.

Please know and observe all prohibitions of use applicable to the products.

NEVER USE THE PRODUCTS FOR AN APPLICATION INVOLVING SERIOUS RISK TO LIFE OR PROPERTY WITHOUT ENSURING THAT THE SYSTEM AS A WHOLE HAS BEEN DESIGNED TO ADDRESS THE RISKS, AND THAT THE OMRON PRODUCT IS PROPERLY RATED AND INSTALLED FOR THE INTENDED USE WITHIN THE OVERALL EQUIPMENT OR SYSTEM.

PERFORMANCE DATA

Performance data given in this document is provided as a guide for the user in determining suitability and does not constitute a warranty. It may represent the result of OMRON's test conditions, and the users must correlate it to actual application requirements. Actual performance is subject to the OMRON Warranty and Limitations of Liability.

CHANGE IN SPECIFICATIONS

Product specifications and accessories may be changed at any time based on improvements and other reasons.

It is our practice to change model numbers when published ratings or features are changed, or when significant construction changes are made. However, some specifications of the product may be changed without any notice. When in doubt, special model numbers may be assigned to fix or establish key specifications for your application on your request. Please consult with your OMRON representative at any time to confirm actual specifications of purchased products.

DIMENSIONS AND WEIGHTS

Dimensions and weights are nominal and are not to be used for manufacturing purposes, even when tolerances are shown.

ERRORS AND OMISSIONS

The information in this document has been carefully checked and is believed to be accurate; however, no responsibility is assumed for clerical, typographical, or proofreading errors, or omissions.

PROGRAMMABLE PRODUCTS

OMRON shall not be responsible for the user's programming of a programmable product, or any consequence thereof.

COPYRIGHT AND COPY PERMISSION

This document shall not be copied for sales or promotions without permission.

This document is protected by copyright and is intended solely for use in conjunction with the product. Please notify us before copying or reproducing this document in any manner, for any other purpose. If copying or transmitting this document to another, please copy or transmit it in its entirety.

Precautions for Safe Use

Please observe the following precautions for safe use of the products.

1. Installation Environment

- Do not use the product in environments where it can be exposed to inflammable/explosive gas.
- To secure the safety of operation and maintenance, do not install the product close to high-voltage devices and power devices.

2. Power Supply and Wiring

- Take care when using a power supply with an overcurrent detector, because this sensor uses DC-DC converter for its power supply circuit and inrush current may activate the protective circuit for a power supply with an overcurrent detector.

Recommended power supply: S8VS-06024 (Omron, DC24 V 2.5 A 60 W)

- The supply voltage must be within the rated range (DC24 V \pm 10 %).
- Reverse connection of the power supply is not allowed.
- Open-collector outputs should not be short-circuited.
- Use the power supply within the rated load.
- High-voltage lines and power lines must be wired separately from this product. Wiring them together or placing them in the same duct may cause induction, resulting in malfunction or damage.
- Use adequate safety measures, for example fail-safe circuits.
- Use a specified-sized wire when wiring. Do not connect wires other than those of the specification to the terminal block.
- For a power supply, use a DC power supply unit provided with a remedy, for example, safety ultralow voltage circuit, to prevent a high voltage from being generated.
- Route so that power supply wires are as short as possible.
- Use a power supply dedicated for this product, without sharing it with other products.
- Tighten fixing screws securely at a torque specified in this manual.
- Before performing any of the following activities, be sure to turn off the product, or breakdown may result.
 - Connecting or wiring cables
 - Connecting or disconnecting connectors
 - Installing or removing Calibration ROM

3. Grounding

- Use a frame ground terminal of the specified size to be grounded. Do not connect a wire with an only twisted end directly to a terminal block.
 - Terminal screw: M4
 - Crimp-type terminal:



- Use D-type grounding (ground resistance of 100 Ω or less). Make the ground point as close as possible and make the ground wire used as short as possible.
- Never a ground wire with other equipment and never ground to building beams. Doing so could cause negative impacts.
- The power supply circuit of the Sensor Controller is not insulated from the internal circuits.
- When grounding the positive (+) terminal of the 24 VDC power supply, do not connect the Sensor Controller's frame ground terminal or PLC's frame ground terminal to ground. [(1), (2)]
The PC housing may be internally connected to the SG (0 V), in which case current will flow through the path shown below and may cause seizure.

- If there is no PC, or specifically there is no SG (0 V)/FG short-circuiting path, grounding the Sensor Controller's frame ground terminal will not cause seizure. Wire the PLC after checking the specification of your PLC.
- The dedicated RS-232C cable (ZW-XRS2/XPT2) has its cable shield isolated from the connector housing. [(3)]

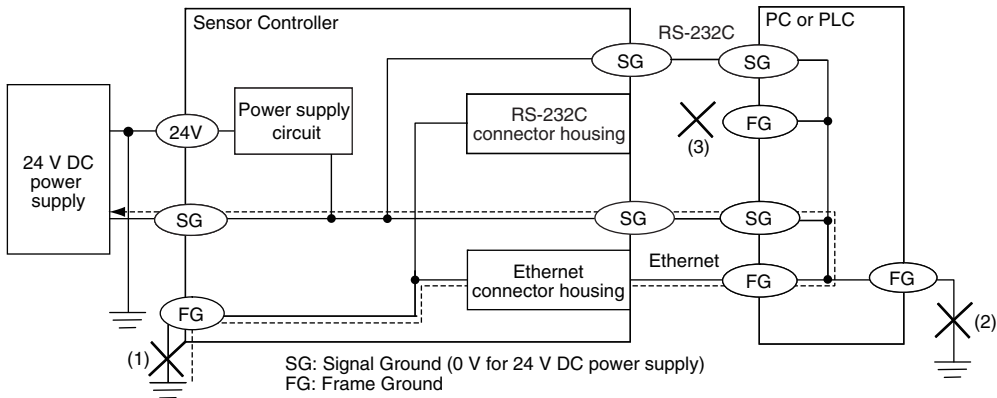

4. Regulations and Standards

- EN61326-1
- Electromagnetic environment : Industrial electromagnetic environment (EN/IEC 61326-1 Table 2)
- The following condition is applied to the immunity test of this product:
There may be cases that current or voltage output fluctuate within $\pm 3\%$ F.S. when a sensor is experienced electromagnetic interference.
- Notice for Korea Radio Law
A 급 기기 (업무용 방송통신기자재)
이 기기는 업무용 (A 급) 전자파적합기기로서 판매자 또는 사용자는 이 점을 주의하시기 바라며 , 가정외의 지역에서 사용하는 것을 목적으로 합니다.

5. Others

- Do not use this product for nuclear facilities, or safety circuits involving human lives.
- Do not attempt to disassemble, repair, modify, apply pressure to deform or burn up the body.
- Dispose of this product as industrial waste.
- Use exclusive devices, including a sensor head, Calibration ROM, fiber cable or RS-232C cable, to connect, or ignition, burst, false operation or breakdown may be caused.
- Do not cut fiber cable. Glass at the cut section may cause injury. Also, if cut, it will not work normally anymore.
- Whenever any trouble, including, strange odor smelled, the body overheated or smoke escaped, was found, immediately stop the operation, and consult an OMRON branch or sales office with the system shut down.
- Do not drop or make a strong impact on the unit.
- Before using any equipment provided with a lock mechanism, make sure that it has been locked.

Precautions for Correct Use

Please observe the following precautions to prevent failure to operate, malfunctions, or undesirable effects on product performance.

1. Installation Site

Do not install the product in locations subjected to the following conditions:

- Ambient temperature outside the rating
- Rapid temperature fluctuations (causing condensation)
- Relative humidity outside the range of 35 to 85 %
- Presence of corrosive or flammable gases
- Presence of dust, salt, or iron particles
- Direct vibration or shock
- Reflection of intense light (such as other laser beams, electric arc-welding machines or ultraviolet shine)
- Direct sunlight or near heaters
- Water, oil, or chemical fumes, spray or mist atmospherics
- Strong magnetic or electric field

2. Power Supply and Wiring

- When using a commercially available switching regulator, make sure that the FG terminal is grounded.
- If surge currents are present in the power lines, connect surge absorbers that suit the operating environment.
- Before turning ON the power after the product is connected, make sure that the power supply voltage is correct, there are no incorrect connections (e.g. load short-circuit) and the load current is appropriate. Incorrect wiring may result in breakdown of the product.
- Use the specified voltage. If voltage exceeding the rating or AC voltage is applied, circuit parts may be burnt or rupture.
- Use the Extension Fiber Cable (ZW-XF□□R) for extending the fiber cable between the Sensor extension fiber cable, five total lengths, 2, 5, 10, 20 or 30 m, are available.
- Handling fiber cables
Use them in compliance with the following. This may result in damage to the fiber cable.
 - Fiber cable bend radiuses must be at least 20 mm.
 - Do not let bending cause stress at the root section of a fiber connector.
 - Do not yank hard on a fiber cable.
 - Do not step on a fiber cable or place anything heavy on it.
 - Do not apply any twisting stress to the fiber cable.
- Be sure to use a Sensor Head and Calibration ROM with the same serial number. A pair with different serial numbers cannot operate normally.
- Use the configuration software with the combination specified in this manual, or the system may operate faultily.
- Do not shut down the power supply when saving any data into the memory built in the Sensor Controller, or the data may be corrupted.
- While a fiber cable is disconnected, be sure to attach the included protective cap on both the Sensor Controller side and the fiber cable side. Leaving the fiber cable with the protective cap not attached, the optical fiber may fail due to any adhered foreign matter.

3. Warming Up

After turning ON the power supply, allow the product to stand for at least 30 minutes before use. The circuits are still unstable immediately after the power supply is turned ON, so measured values may fluctuate gradually.

4. Maintenance and Inspection

Do not use thinner, benzene, acetone or kerosene to clean the Sensor Head, fiber cable and Sensor Controller. If large dust particles adhere to the emitter/receiver of the Sensor Head or Sensor Controller, use a blower brush (used to clean camera lenses) to blow them off. Do not blow the dust particles with your mouth.

To remove smaller dust particles, dirt, oil, and fat, wipe gently with a soft cloth (for cleaning lenses). Do not use excessive force to wipe off dust particles. Scratches on the emitter/receiver may cause false operations or measuring errors.

For details on the method for cleaning the ends of fiber cables, refer to "Connecting Fiber Cable" (p.34).

Clean the ventilation port periodically to prevent any build up of dirt and dust. If the ventilation port is blocked, heat builds up inside and can cause breakdown.

5. Sensing Objects

The product sometimes cannot accurately measure the following types of objects: Transparent objects, objects with an extremely low reflection factor, objects smaller than the spot diameter, objects with a large curvature, excessively inclined objects, target objects with a thin film on the surface etc.

6. Effect caused by peripheral lights

Do not install the Sensor Head in a place where strong light hits the laser emitter/receiver section of the Sensor Head. Also, if an object has a shiny surface, the light from the lighting will be reflected and a malfunction may occur. In such a case, prevent reflection by, for example, covering the light to stop reflection.

 Basic precautions for installation p.26

7. Influence by Air Turbulences

Slow air turbulences around the Sensor Head may disperse measured values.

To avoid these possible air turbulences, wrap the Sensor Head with an appropriate cover.

8. Operations Outside Measurement Range

This sensor is highly sensitive, it may operate incorrectly outside the measurement range (too close in). In such a case, the problem can be solved by reducing the exposure time.

Editor's Note

■ Meaning of Symbols

Menu items that are displayed on the main or sub-display, and windows, dialog boxes and other GUI elements displayed on the personal computer are indicated enclosed by brackets [].

■ Visual Aids

Important

Indicates points that are important to achieve the full product performance, such as operational precautions.

Note

Indicates application procedures.



Indicates pages where related information can be found.

Optional

Indicates that the setting is optional in a configuration procedure.

Copyrights and Trademarks

- Windows, Windows XP, Windows Vista, Windows 7, and Windows 8 are registered trademarks of Microsoft Corporation in the USA and other countries.
- Other system names and product names that appear in this manual are the trademarks or registered trademarks of the respective companies.

Notice

- Photocopying, duplication, or copying of all or part of this manual without permission is prohibited.
- Please understand that the specifications and other contents of this manual are subject to change for improvement without notice.
- Every effort has been made to ensure the accuracy of the contents of this manual, but if you should notice any mistake, questionable section, or the like in this manual, please contact an OMRON branch or sales office.
- If you do so, please also tell us the manual number, which is found at the end of the manual.

Table of Contents

Editor's Note	7
Copyrights and Trademarks	8
Notice	8
Search from Settings	14

1. Basic configuration

1-1 ZW-series Displacement Sensors	16
Types of Sensor Controllers	16
1-2 Basic Operation Flow	17

2. Installation and Connections

2-1 System Configuration	20
System Configuration	20
Connection Compatibility	21
2-2 Part Names and Functions	22
Sensor Head	22
Calibration ROM	22
Sensor Controller	23
2-3 Installation	26
Installation of Sensor Head	26
Installation of Sensor Controller	31
Connecting Calibration ROM	33
Connecting Fiber Cable	34
Calibrating Sensor Head	38
2-4 Wiring	40
20-pole terminal block	40
52-pole extension connector	43
Electrical Specifications	46
2-5 Installing the Sysmac Studio	48

3. Basic Operation

3-1 Launching a project	50
Connecting to the sensor with PC tool	50
Entering project information	51
3-2 Explanation of Screen Sections	52

PC tool	52
3-3 Switching operation modes	57
3-4 Bank switching	58
Multi-task and Bank Data	58
Switching Banks	60
3-5 Perform the Zero Reset	61
Zero reset	61
3-6 Setting Threshold Value	64
Threshold Value Settings	64
3-7 Saving a project	66
Saving a project	66
Exporting a project	66
Importing a project	66
3-8 Operating with Sensor Controller	67

4.Settings for Function

4-1 Setting Sensing	70
Selecting the Area Mode	70
Setting the Material of the Target to Measure	71
Setting the Noise Cut Level	72
Setting Smoothing Size	73
Setting Start Direction of Count Measurement Surfaces	74
Setting Exposure Time Control Mode	75
Setting the Measurement Area	76
4-2 Setting Measurement Items	79
What is a Measurement Item?	79
Measuring the Height	79
Measuring the Thickness	81
Performing Calculations	82
4-3 Setting the Output Conditions	83
Setting Scaling	83
Setting Filters	89
Setting Hold	94
Setting the Zero Reset	101
4-4 Setting the Banks	106
Changing the Bank Mode	106
Copying the Bank/System Settings	107
Saving the Bank/System Settings	108
Clearing the Bank Settings	109
4-5 Setting the System	110
Checking Information	110
Making Sensor Settings	111

Initializing Settings	112
---------------------------------	-----

5. Convenient Functions

5-1 Displaying measured values in graphs.	116
Specifying the sampling start and end conditions	118
Starting and ending sampling before and after the trigger condition is met	120
5-2 Saving measured values in a file.	121
Outputting the results of sampling as a file	121
Exporting the results of sampling	121
5-3 Displaying saved measured values.	124
5-4 Performing internal logging.	125
5-5 Storing the light reception wave form in a file	127
5-6 Recovering calibration ROM data	129
5-7 Printing the contents of settings	130
5-8 Controll input signal with PC tool	131

6. Communications with External Devices

6-1 Parallel I/O connection	134
I/O Signal Functions	134
Settings for Analog Output	138
Settings for Judgment Output	143
Settings for Binary Output	146
Settings for Processing When Measurement Is Not Possible	150
Settings for Bank Control	153
Settings for Internal Logging	154
Timing Chart	155
6-2 No-protocol Connection.	169
Outline of No-protocol Communications	169
Setting Up No-protocol Communications	170
Setting Communications Specifications (RS-232C Communications)	173
Setting for serial data output after application of measured value	174
Command List	178
Command Format	180

7. Offline Settings

7-1 Performing Settings Offline	204
7-2 Starting a Project in Offline Mode	205
7-3 Changing between Online and Offline	206

8. Troubleshooting

8-1 Error Messages.	208
------------------------------------	------------

Errors for Ethernet Connection	208
Errors Common to All Communication States	209
8-2 Troubleshooting	210

9.Sensor controller operations

9-1 Search from Menu Tree	214
FUN Mode Menu	214
RUN (run) Mode Menu	219
9-2 Functions of Operating Keys	220
9-3 Digital Displays	221
9-4 Switching operation modes	222
9-5 Functions and Operations during Measurement	224
Switching the RUN (Run) Mode Display	224
9-6 Setting Sensing	228
Setting the Material of the Target to Measure	228
Setting Start Direction of Count Measurement Surfaces	229
Setting Exposure Time Control Mode	230
9-7 Setting Measurement Items	231
Measuring the Height	231
Measuring the Thickness	232
Calculating	233
9-8 Setting the Output Conditions	236
Setting the Filter	236
Setting Scaling	240
Setting Hold	244
Setting the Zero Reset	248
9-9 Setting the Banks	252
Switching Banks	252
Changing the Bank Mode	253
Copying the Bank Settings	254
Saving the Bank/System Settings	255
Clearing the Bank Settings	256
9-10 Setting Threshold Value	257
Teaching	257
Direct	259
9-11 Setting the System	260
Checking Information	260
Setting the Key Lock	261
Calibrating Sensor Head	262
Initializing Settings	263
9-12 Connecting Parallel I/O	264
Settings for Analog Output	264

Settings for Binary Output	268
Settings for Judgment Output	271
Settings for Processing When Measurement Is Not Possible	273
Setting for Internal Logging	275
9-13 Connecting by No-protocol Communications	277
Initial Settings for No-protocol Communications	277
Setting Communications Specifications (RS-232C Communications)	278
Setting Serial Data Output	279
Set the delimiter	280

10.APPENDICES

10-1 Specifications and External Dimensions	282
Sensor Head	282
Sensor controller	294
PC tools (Sysmac Studio)	298
Accessories	299
EMC Directive Conformity	303
10-2 Firmware update	304
Use PC tools (Sysmac Studio) to update.	304
Performing the Update on Warp Engine ZW	305
10-3 Processing Item Data List	308
10-4 System data list.....	313
Index	315
Revision History.....	318

Search from Settings

Settings	Set by Sysmac Studio	Set by Sensor Controller
Setting the Material for the Target to Measure	p.71	p.228
Setting Exposure Time Control Mode	p.75	p.230
Measuring the Height	p.79	p.231
Measuring the Thickness	p.81	p.232
Calculating	p.82	p.233
Setting the Filter	p.89	p.236
Setting the Scaling	p.83	p.240
Setting the Hold	p.94	p.244
Setting the Zero Reset	p.101	p.248
Changing the Bank Mode	p.106	p.253
Copying the Bank/System Settings	p.107	p.254 (Bank Settings only)
Saving the Bank/System Settings	p.108	p.255
Clearing the Bank Settings	p.109	p.256
Checking Information	p.110	p.260
Setting the Key Lock	p.111	p.261
Initializing Settings	p.112	p.263

Basic configuration

1-1 ZW-series Displacement Sensors	16
1-2 Basic Operation Flow	17

1-1 ZW-series Displacement Sensors

The ZW-series is a line of fiber coaxial displacement sensors.

They consist of Sensor Head and Sensor Controller, calibration ROM, and exclusive setting PC tool which runs on personal computers for system settings and monitoring.

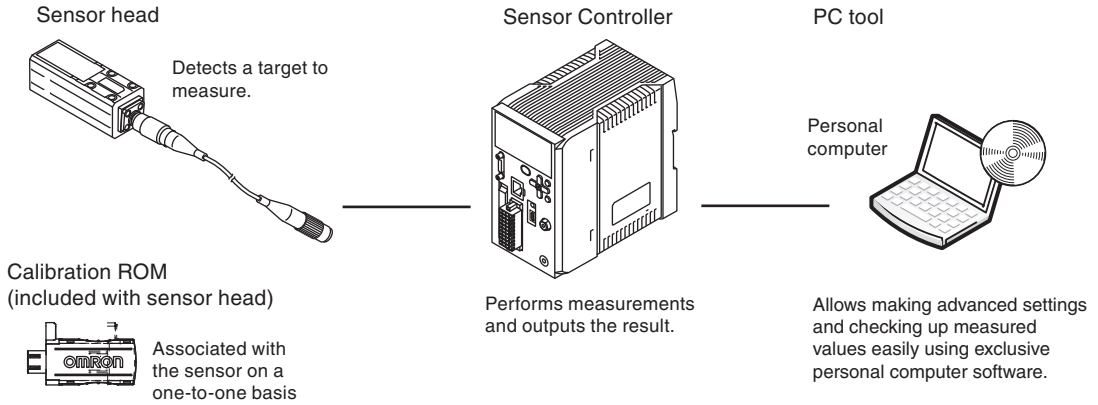

Types of Sensor Controllers

The ZW Series has two types of Controllers (hereinafter be referred to as "Sensor Controller" in this document.). Differences are described below.

Model	ZW-C1□T/ZW-C1□AT	ZW-CE1□T
I/O Specifications	EtherCAT and EtherNet/IP not mounted, Binary output device mounted	EtherCAT and EtherNet/IP mounted, Binary output device not mounted
PC tool	Sysmac Studio (Measurement Sensor Edition)/ Smart MonitorZW version 1.10 or later	Sysmac Studio (Standard Edition)/ Sysmac Studio (Measurement Sensor Edition)/Smart MonitorZW version 1.10 or later

1-2 Basic Operation Flow

The following is the basic operation flow for ZW Series.

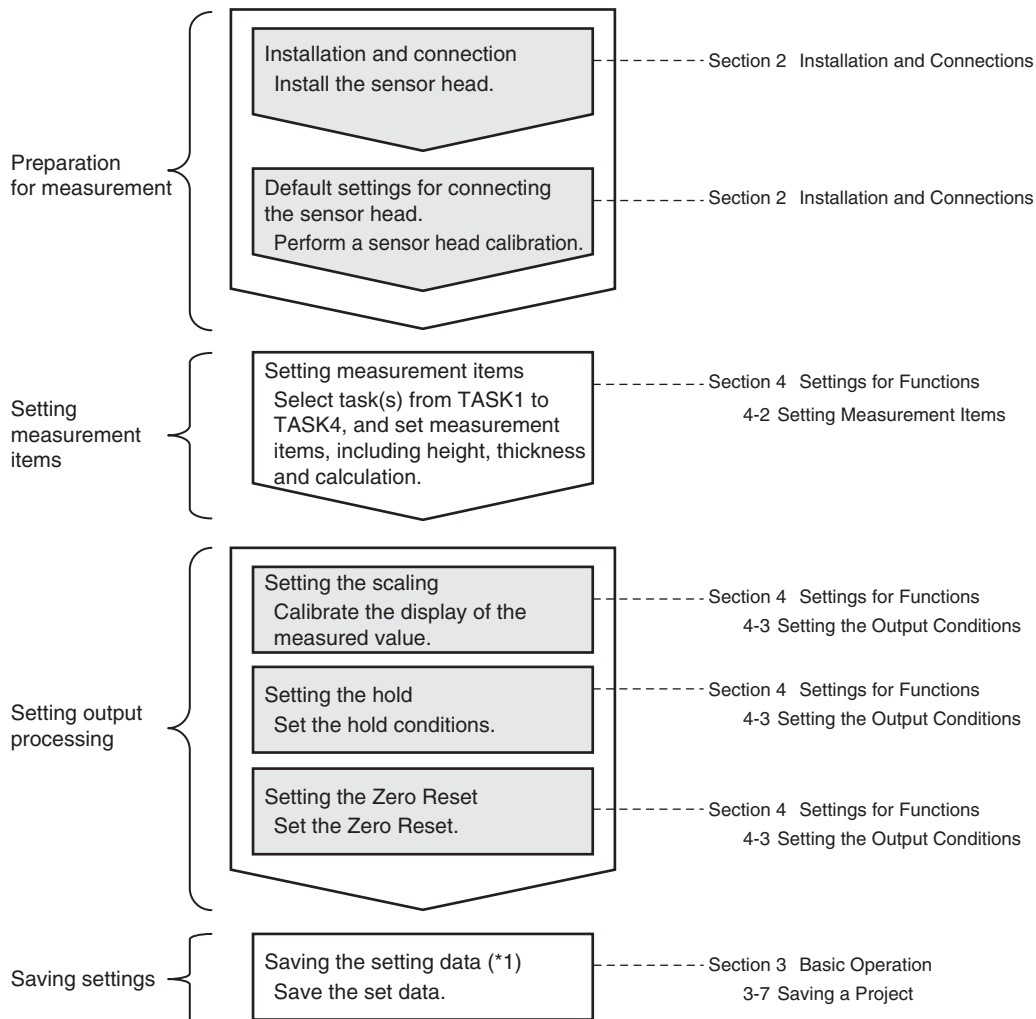

(*1) After you have made or changed settings, be sure to save the setup data. All set data will be cleared if you turn the power OFF without saving the data.

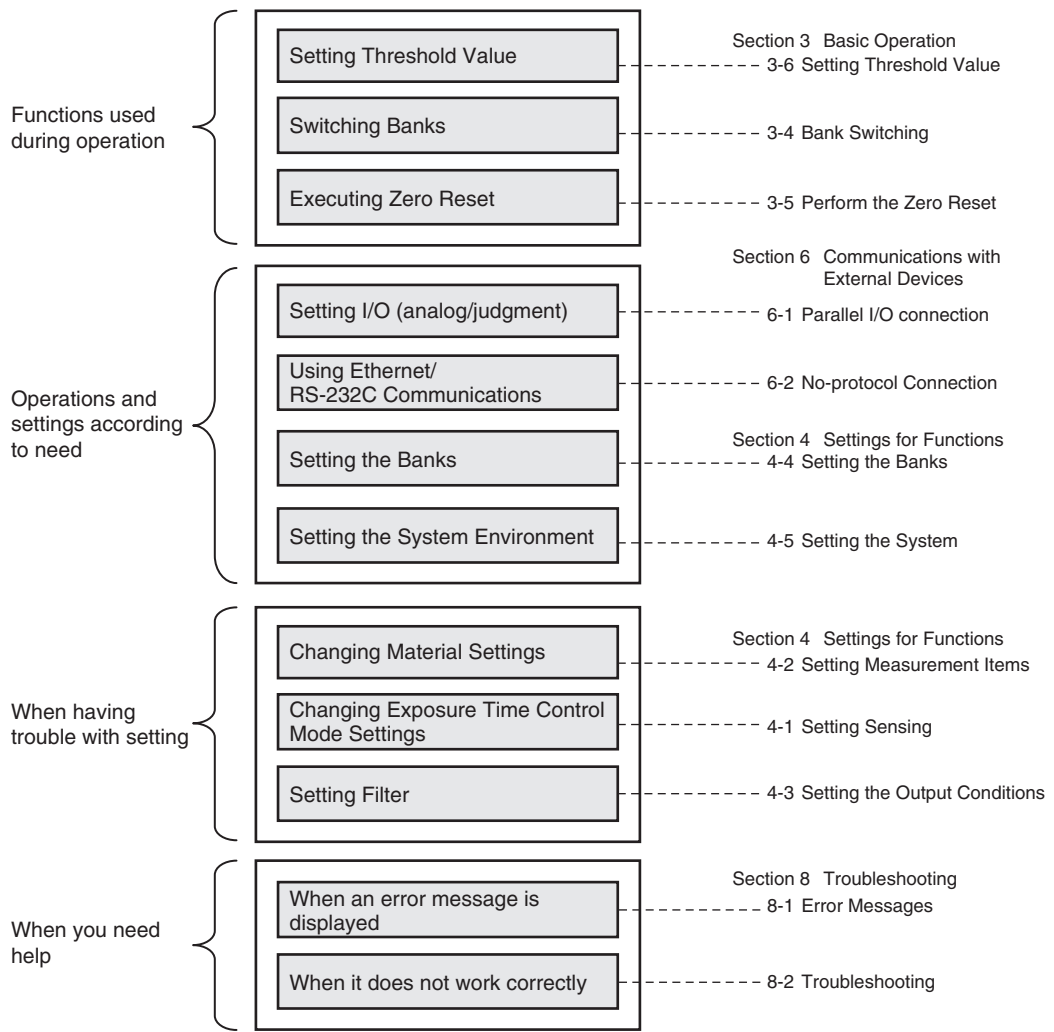

Installation and Connections

2-1 System Configuration	20
2-2 Part Names and Functions	22
2-3 Installation	26
2-4 Wiring	40
2-5 Installing the Sysmac Studio.	48

2-1 System Configuration

System Configuration

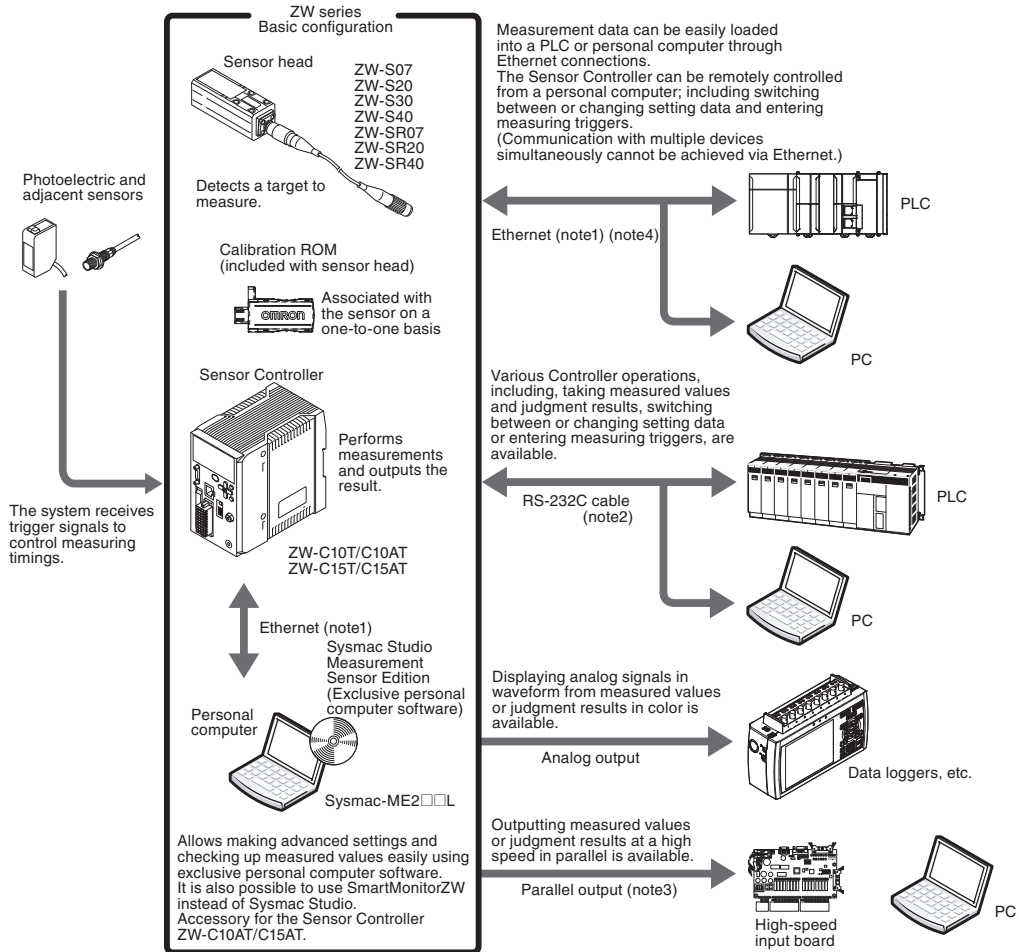

• (Note1) Ethernet cable (sold separately)
 Prepare commercially available Ethernet cable satisfying the following requirements:
 - Category 5e or more, 30 m or less
 - RJ45 connector (8-pin modular jack)
 - For direct connection: Select cross cable.
 - For connection through an industrial switching hub (note 4): Select straight cable.

• Extension fiber cable (optional)
 An exclusive extension fiber cable is available to place the Sensor Head and Sensor Controller far apart than the normal distance to each other. Use the exclusive product for correct measurements.

Connecting adapter (included with the fiber cable for extension) ZW-XFC
 Extension fiber cable ZW-XF_R (2 m/5 m/10 m/20 m/30 m)

• (Note2) RS-232C cable (optional)
 Depending on connecting devices, exclusive cables may be supplied.

For PLC/programmable terminal: ZW-XPT2
 For personal computer: ZW-XRS2

• (Note3) Parallel cable (optional)
 A parallel cable for 52-pole extension connector (ZW-XCP2) with 2 m cable is available.

• (Note 4) Industrial network hub (sold separately)
 Use the recommended products below:
 W4S1-0_ (Omron)

3-port type 5-port type

Connection Compatibility

Connected to ZW-C1□T	Other connection		
	Ethernet (no-protocol)	RS-232C (no-protocol)	I/O Cable
Ethernet (no-protocol)	---	Compatible	Compatible
Ethernet (programmable no- protocol)	Compatible	---	Compatible

Important

Can be connected simultaneously via Ethernet with PC tools (Sysmac Studio, SmartMonitorZW) and another device (PLC etc). Can be connected simultaneously via Ethernet with PC tools (Sysmac Studio, SmartMonitorZW) and another device (PLC etc). The port number for the PC tool is fixed to 9600. When connecting different devices, set the port number to other than 9600 (default value is 9601).

Product	Model	Application
ZW	ZW-C1□T	This Displacement Sensor performs measurements.
PC Tool	Sysmac Studio Measurement Sensor Edition • SYSMAC-ME2□□L (1 or 3 licences)	This is the setup application. It is part of the Sysmac Studio Package and it runs on Windows. This license provides the functions that are required to set up ZW Vision Sensors from the Sysmac Studio. This model number is for the license only. You must also purchase the DVD for the Sysmac Studio Standard Edition Ver.1.05 or higher.
General-purpose Ethernet cable	---	Prepare commercially available Ethernet cable satisfying the following requirements: <ul style="list-style-type: none"> • Category 5e or more, 30 m or less • RJ45 connector (8-pin modular jack) • For direct connection: Select cross cable. • For connection through an industrial switching hub: Select straight cable.
Special I/O Cable	For connecting to a PLC or programmable terminal • ZW-XPT2 For connecting to a PC • ZW-XRS2	Connect the sensor with a PLC, programmable terminal, or personal computer etc..
Industrial Ethernet Switching Hub	• W4S1-03B (3 ports type) • W4S1-05B • W4S1-05C (5 ports type)	Used to connect multiple sensors or PLCs using Ethernet.

2-2 Part Names and Functions

The following describes the names and functions of parts of the Sensor Head, Calibration ROM and Sensor Controller.

Sensor Head

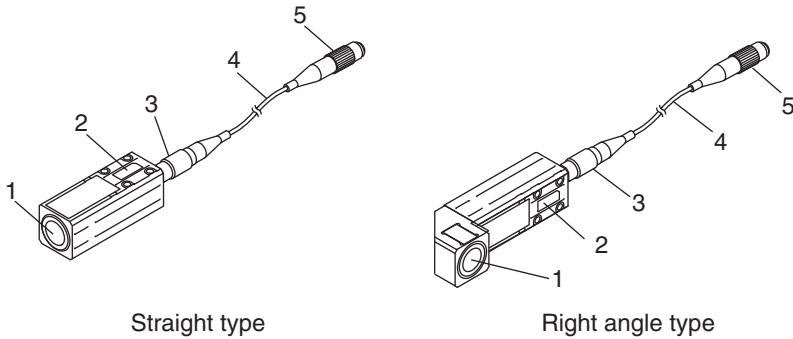

No.	Names	Functions
1	Projector/receiver	Projects and receives light.
2	Serial number.	Serial number. Only a calibration ROM with the same serial number is available.
3	Fiber interface	Interfaces the Sensor Head and optical fiber (unremovable).
4	Fiber Cable	Sends or receives light signals to/from the Sensor Controller.
5	Fiber Connector	Couples the Sensor Controller and fiber cable.

Calibration ROM

This ROM is associated with the sensor on a one-to-one basis, and operates connected to the Sensor Controller.

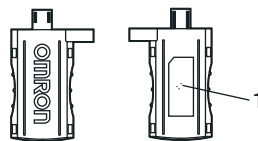

No.	Names	Functions
1	Serial number	Serial number. Only a Sensor Head with the same serial number is available.

Important

Use with the Calibration ROM always connected. If the Calibration ROM is not connected, an error is displayed.

Sensor Controller

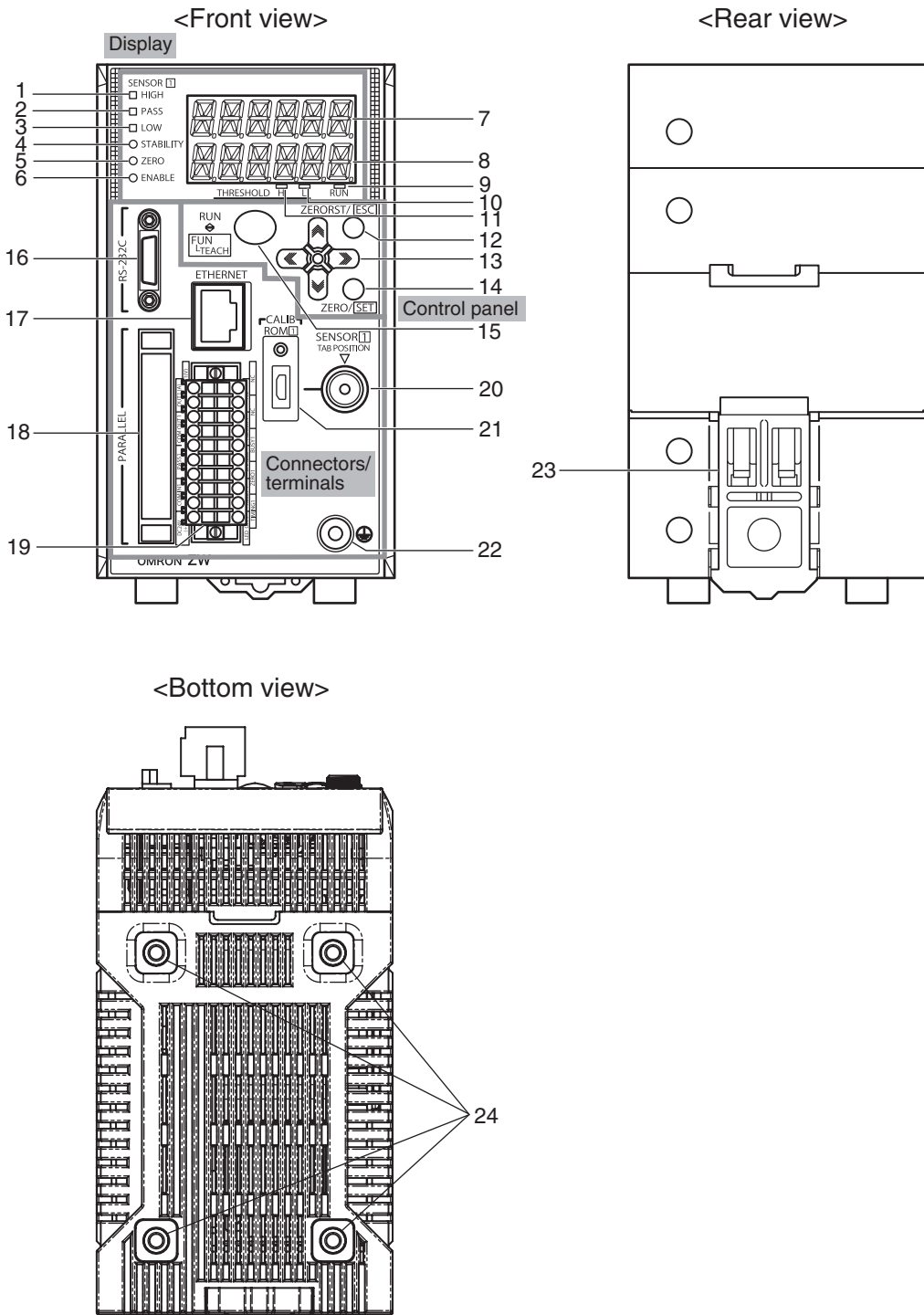

Front view

● Display

No.	Names (light color)	Functions
1	HIGH indicator (orange)	The HIGH indicator is lit while judgment is resulted in HIGH (HIGH threshold value < measured value).
2	PASS indicator (green)	The PASS indicator is lit while judgment is resulted in PASS (LOW threshold value ≤ measured value ≤ HIGH threshold value).
3	LOW indicator (orange)	The LOW indicator is lit while judgment is resulted in LOW (measured value < LOW threshold value).
4	STABILITY indicator (green)	The STABILITY indicator is lit while a measured value is within the measuring range. It goes out if a measured value is out of the measuring range.
5	ZERO indicator (green)	The Zero Reset indicator is lit while the zero reset function is enabled.
6	ENABLE indicator (green)	The ENABLE indicator lights when the Sensor is ready for measurement. It goes off when measurement is not possible (e.g. when the received light amount is excessive or insufficient, when the measuring range is exceeded, when the calibration ROM is not connected, or when measurement is not being performed in FUN mode).
7	Main display (red)	The main display shows measured values and/or function names.
8	Sub-display (green)	The sub-display shows additional information for measured values or setting values for functions.
9	RUN indicator (green)	The RUN indicator is lit in the RUN mode, and goes out in the FUN mode.
10	THRESHOLD-L indicator (orange)	The LOW threshold value indicator is lit when the Sub-display indicates a LOW threshold value.
11	THRESHOLD-H indicator (orange)	The HIGH threshold value indicator is lit when the Sub-display indicates a HIGH threshold value.

● Control panel

No.	Names	Functions
12	ZERORST/ESC key	These keys function differently depending on operation modes.  9-2 Functions of Operating Keys p.220
13	← (LEFT) key → (RIGHT) key ↑ (UP) key ↓ (DOWN) key	
14	ZERO/SET key	
15	Mode switching key	

● Connectors/terminals

No.	Names	Functions
16	RS-232C connector	Connect the RS-232C cable when you are connecting the system with a PLC or personal computer through RS-232C. For the RS-232C cable, please use the following exclusive products: If you use a cable not included in the exclusive products, a false operation or breakdown may result. <ul style="list-style-type: none"> • For connecting to a PLC or programmable terminal: ZW-XPT2 • For connecting to a PC: ZW-XRS2
17	Ethernet connector	This connector is used to connect with a personal computer through Ethernet. Prepare commercially available Ethernet cable satisfying the following requirements: <ul style="list-style-type: none"> • Category 5e or more, 30 m or less • RJ45 connector (8-pin modular jack) • For one-to-one connection: Select cross cable. • For connection through an industrial switching hub: Select straight cable. (Recommended hub: W4S1-0□ (Omron))
18	52-pole expansion connector	The 52-pole expansion connector is used to utilize extended functions, such as binary I/Os, including output for measured value, GATE signal or binary output task number outputs, or binary output object task selection input signals; or bank I/O, including bank number output or bank select input . A parallel cable for 52-pole extension connector (ZW-XCP2) with 2 m cable is available.
19	20-pole terminal block	The 20-pole terminal block connects the Sensor Controller DC24 V power supply and basic I/Os, including output for analog voltage, analog current, judgment, ALARM, BUSY or ENABLE, or input for ZERO, RESET, TIMING or LED-OFF. The length of Cables should be less than 30 m.
20	Fiber connector	The fiber connector connects the fiber cable.
21	ROM connector	The ROM connector connects the calibration ROM.
22	Frame ground terminal	This is the connector for frame ground. It connects grounding wire.

Rear view

No.	Names	Functions
23	DIN track attachment hook	Used when fixing the Sensor Controller on DIN track.

Bottom view

No.	Names	Functions
24	Installation hole	Used when fixing the Sensor Controller with screws.

2-3 Installation

Installation of Sensor Head

Installation procedure

- 1 Place the Sensor Head with an appropriate distance from the target to measure, fixing it by tightening four M3 screw inserted into their respective installation holes.

Tightening torque: 0.54 N • m

 10-1 Specifications and External Dimensions p.282

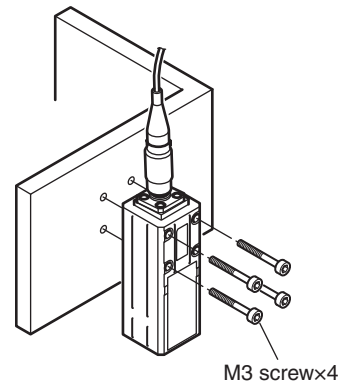

Important

- For the location screw holes, see the external dimensions.
- When measuring on a high-reflectivity object, such as a mirror or wafer, false measured values beyond the measuring range may be outputted. When an object with diffuse reflection is used, we recommend installing and adjusting while watching the position of the spot.

Basic precautions for installation

Do not install the Sensor Head in a place where strong light hits the laser emitter/receiver section of the Sensor Head. Also, if an object has a shiny surface, the light from the lighting will be reflected and a malfunction may occur. In such a case, prevent reflection by, for example, covering the light to stop reflection.

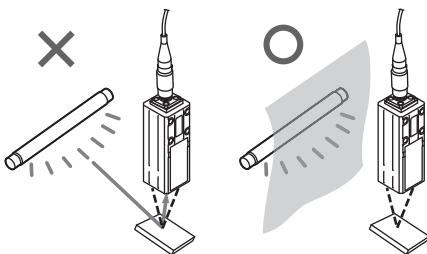

Measuring range

With the ZW series, the measurement center distance is expressed as 0 with the NEAR side as + and the FAR side as -.

Straight type

● ZW-S07

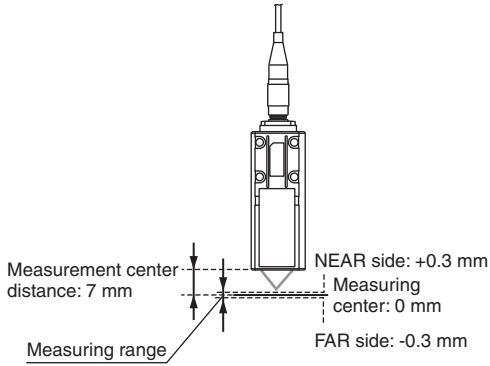

● ZW-S20

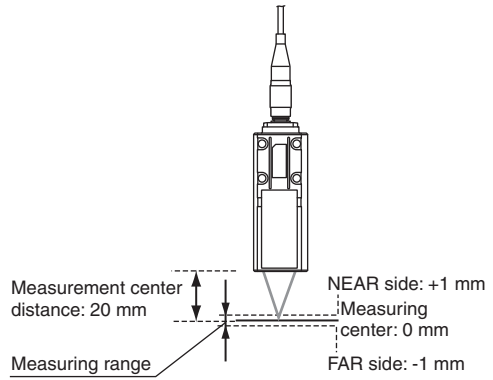

● ZW-S30

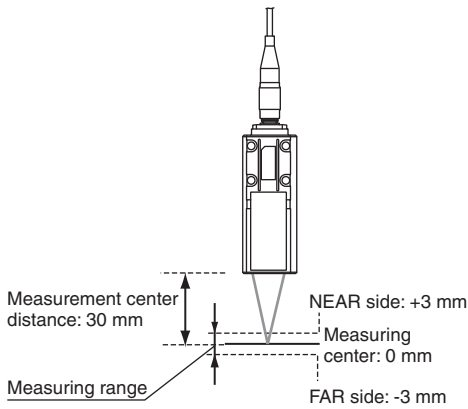

● ZW-S40

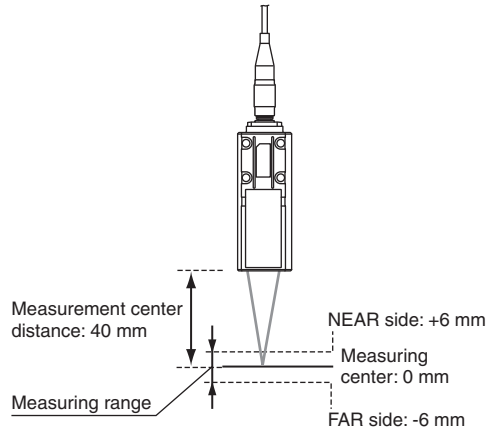

Right angle type

● ZW-SR07

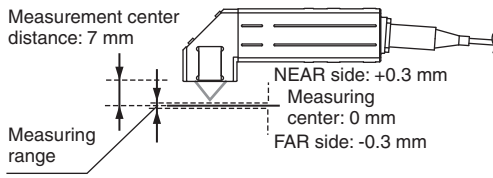

● ZW-SR20

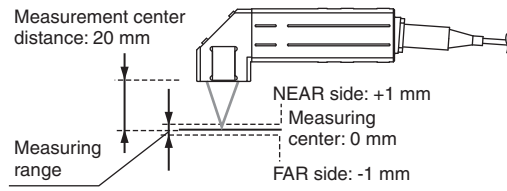

● ZW-SR40

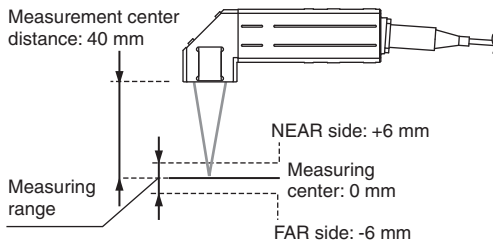

Mutual interference

When using two or more Sensor Heads next to each other, mutual interference will not occur if other beam spots are outside the ■ areas in the following diagrams.

Straight type

● ZW-S07

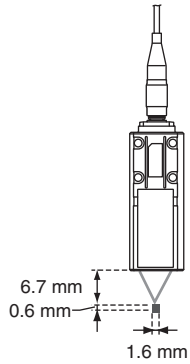

● ZW-S20

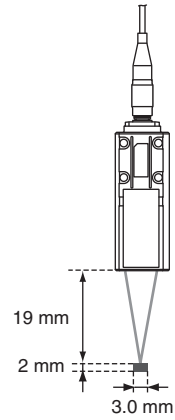

● ZW-S30

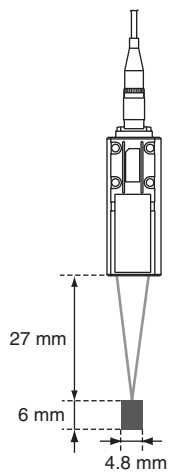

● ZW-S40

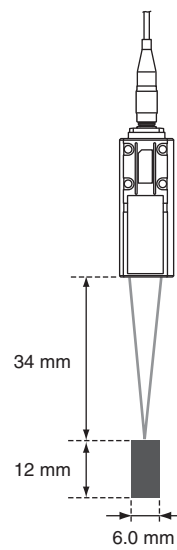

Right angle type

● ZW-SR07

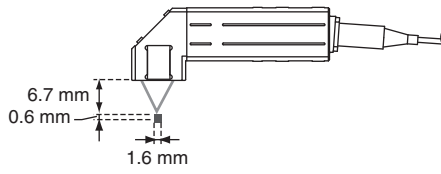

● ZW-SR20

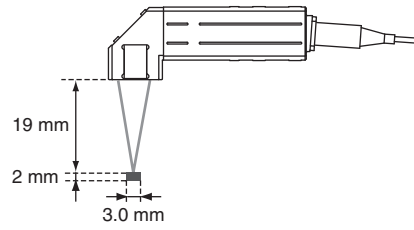

● ZW-SR40

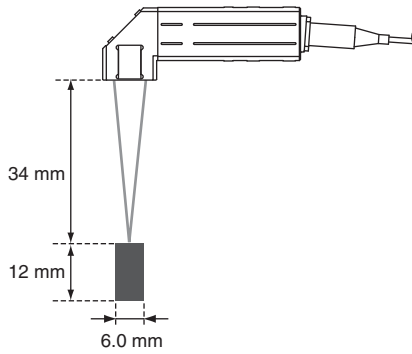

Installation of Sensor Controller

Precautions for installation

Install the Sensor Controller in the orientation indicated by the circle mark in the following figure. Do not install it laying on its side or upside down.

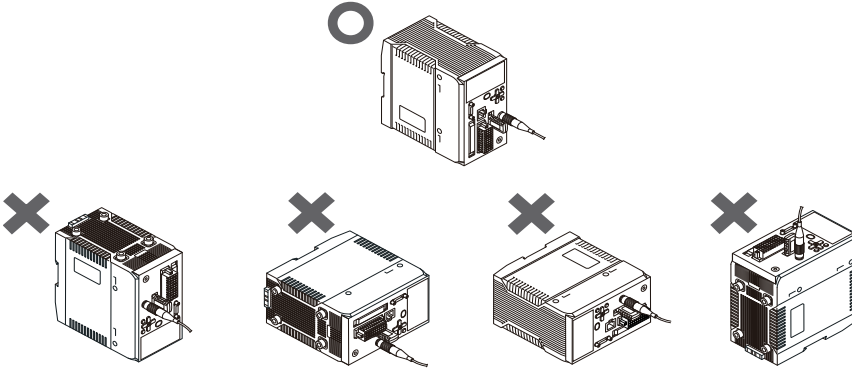

For adequate intake and/or exhaust, keep the Sensor Controller clear by 30 mm or more on its top, and by 10 mm or more from either side.

To secure the Sensor Head and cables connected safely, keep the front of the Sensor Controller clear by 65 mm or more.

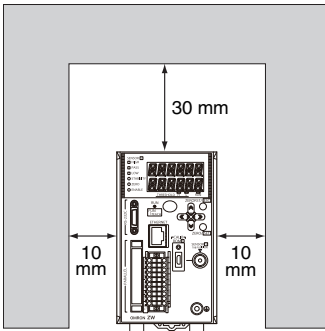

If more than one Sensor Controller must be placed in parallel, place them 10 mm or more apart each other, keep them clear by 30 mm or more on their top and 30 mm or more under them.

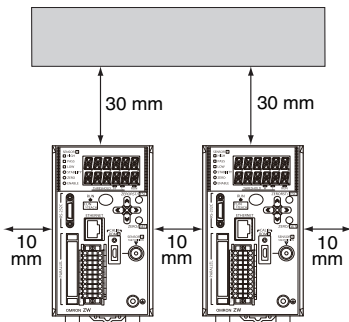

Important

Do everything possible to avoid installation in a location with vibration.

Installing on the DIN track

The following describes how to attach the Sensor Controller on a 35 mm-wide DIN track.

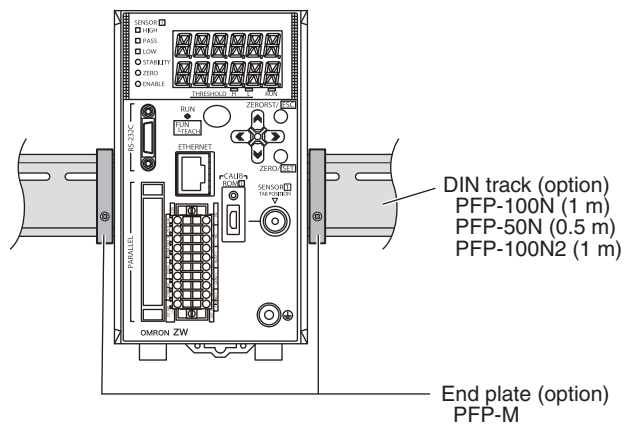

Installation procedure

- 1** Hook the upper edge of the Sensor Controller's back slot onto the upper edge of the DIN track.
- 2** Push the Sensor Controller down onto the DIN track until the DIN track attachment hook is locked. Push in until you hear a "click" sound.

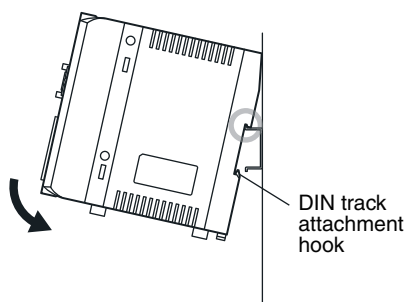

Important

Always hook the upper edge of the slot on the Sensor Controller's back first onto the DIN track. Hooking the Sensor Controller starting from the lower edge of the slot may impair the mounting strength. After completely installing the Sensor Controller, make sure that it is securely fixed.

Removal procedure

- 1** Pull DIN track attachment hook downwards using a slotted screwdriver or an equivalent.
- 2** Lift up the Sensor Controller from the lower side, and remove it from the DIN track.

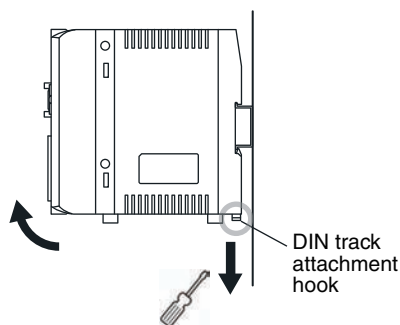

Installing on bottom

The following describes how to attach the Sensor Controller on its bottom.

1 Drill four installation holes on the base.

Important

For the location installation holes, see the external dimensions.

 10-1 Specifications and External Dimensions
p.282

2 Tighten four M4 screws to fix the Sensor Controller on the base.

Tightening torque: 1.2 N • m

Sensor Controller thread depth: 6 mm

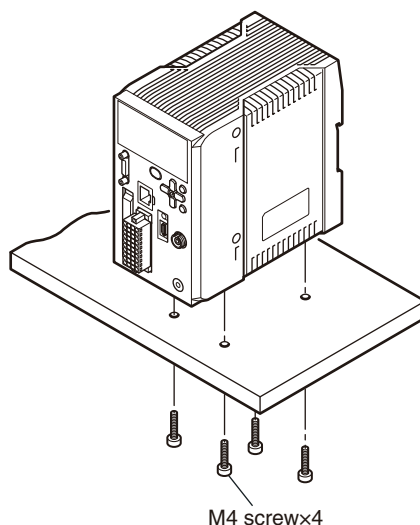

Connecting Calibration ROM

To connect the calibration ROM to the Sensor Controller, follow the steps below:

1 Connect the calibration ROM to the ROM connector on the Sensor Controller.

2 Fix the calibration ROM by tightening the supplied M2 screw.

Tightening torque: 0.15 N • m max.

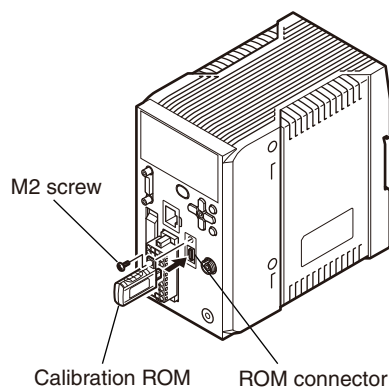

Important

- Before connecting or disconnecting the calibration ROM, make sure that the Sensor Controller's power supply is turned OFF. The Sensor Controller may break down if the calibration ROM is connected while the power is ON.
- Use with the Calibration ROM always connected. If the Calibration ROM is not connected, an error is displayed.
- Only a calibration ROM and Sensor Head with a same serial number are compatible. When connecting a calibration ROM with a Sensor Head, make sure that they have a same serial number, or measurement cannot be performed correctly.

Connecting Fiber Cable

Connect the fiber cable on the Sensor Head to the Sensor Head connector on the Sensor Controller as follows:

- 1 Remove the protective caps from the Sensor Controller's fiber connector and the fiber cable.

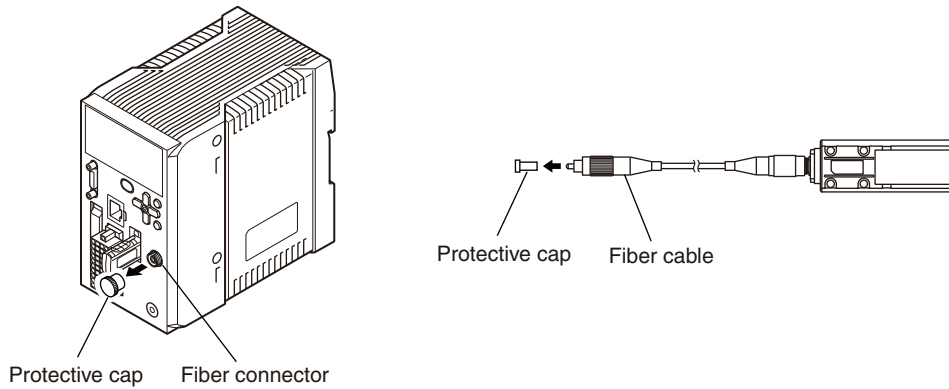

Important

Do not discard but keep the protective cap handy.

- 2 Mate the convex section on the fiber cable with the groove on the fiber connector and turn the threaded section clockwise while pushing in (see figure 1).

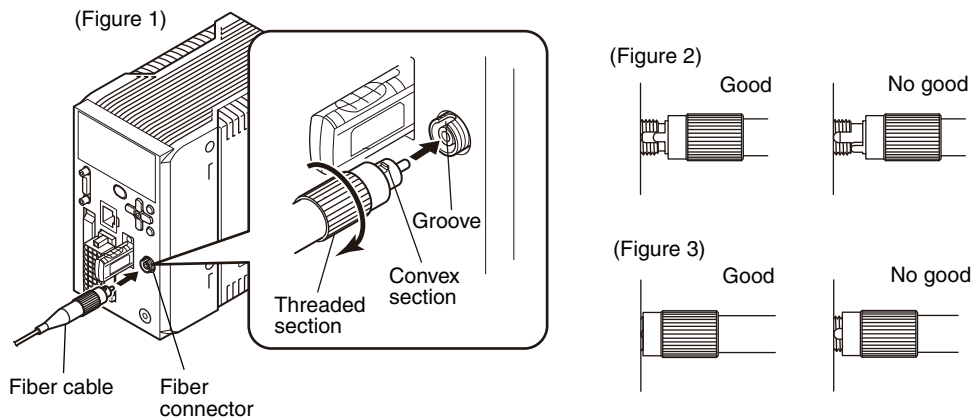

In the "No good" status in figure 2 and figure 3, optic signals cannot be transmitted and correct measurement is not possible. Always check that the system is in the "Good" status.

Important

- Handling fiber cables

Use them in compliance with the following.

-Fiber cable bend radiuses must be at least 20 mm.

-Do not let bending cause stress at the connecting section of a fiber connector.

-Do not yank hard on a fiber cable.

-Do not step on a fiber cable or place anything heavy on it.

- Do not touch the end surface of a fiber cable, or the cable may be degraded in performance. Should the end surface be touched or soiled, wipe the dirt away using a commercially available cleaner exclusive for fiber or dry and soft cloth. Do not use a cloth moistened with alcohol, or the dirt may be reattached.

We recommend the following product as the fiber cleaner.

Point	Item	Model	Manufacturer
Tip of fiber cable	OPTIPOP R1	ATC-RE-01	NTT Advanced Technology Corporation

- Use the optional ZW-XCL when cleaning the groove of the fiber connector.



Fiber connector cleaner p.300

- The fiber cable and fiber connectors should not be left with their protective caps removed, not even for a short period of time. Leaving them unprotected can let dirt get on the end surface and cause performance deterioration.
- Calibrate the Sensor Head after removing and inserting a fiber cable.



Calibrating Sensor Head p.38

Extending fiber cable

To extend the fiber cable on the Sensor Head, use an extension fiber cable and connecting adapter.

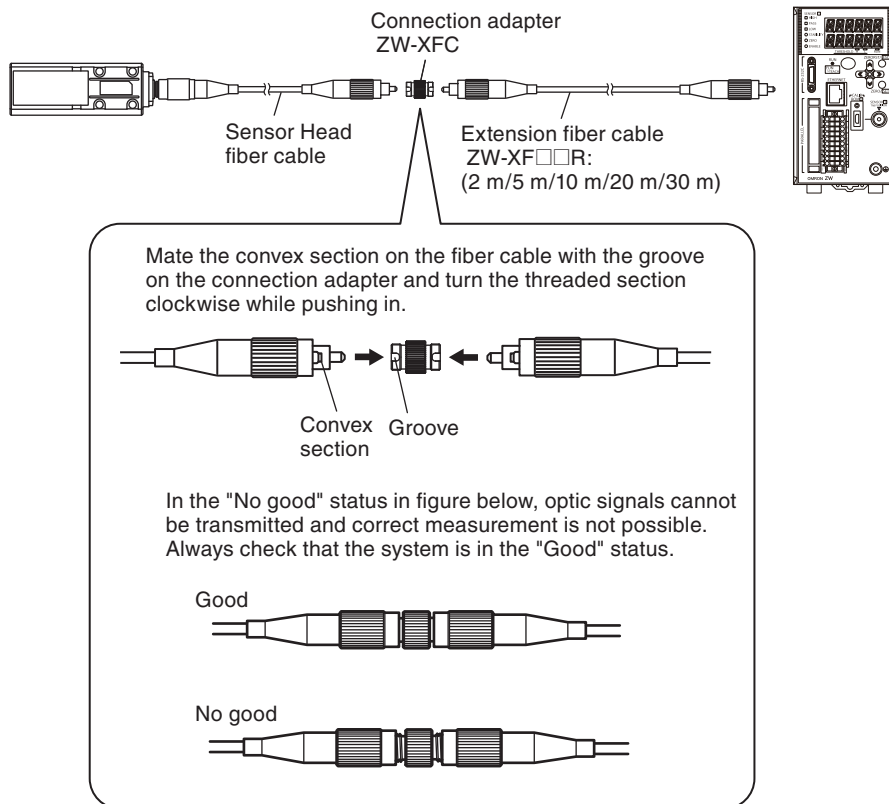

Extension fiber cable (option)

Model	Length
ZW-XF02R	2 m
ZW-XF05R	5 m
ZW-XF10R	10 m
ZW-XF20R	20 m
ZW-XF30R	30 m

Connecting adapter (option)

Model
ZW-XFC

Important

- The connection adapter (ZW-XFC) comes packed together with the extension fiber cable (ZW-XF□□R).
- Never use any extension fiber cable and/or connecting adapter other than those specified in the above.
- Hold the combined length of the normal and extension fiber cables to no more than 32 m.
- Only one fiber cable is allowed to extend the normal fiber cable. Never use two or more extension fiber cable connected together.
- Do not touch the end surface of a fiber cable, or the cable may be degraded in performance. Should the end surface be touched or soiled, wipe the dirt away using a commercially available cleaner exclusive for fiber or dry and soft cloth. Do not use a cloth moistened with alcohol, or the dirt may be reattached.

We recommend the following product as the fiber cleaner.

Point	Item	Model	Manufacturer
Tip of fiber cable	OPTIPOP R1	ATC-RE-01	NTT Advanced Technology Corporation

- Use the optional ZW-XCL when cleaning the groove of the fiber connector.

 Fiber connector cleaner p.300

- The fiber cable and fiber connectors should not be left with their protective caps removed, not even for a short period of time. Leaving them unprotected can let dirt get on the end surface and cause performance deterioration.
- Calibrate the Sensor Head after removing and inserting an optical fiber.

 Calibrating Sensor Head p.38

Calibrating Sensor Head

Calibrate the Sensor Head by obtaining the dark data in the no-incoming light status.

- When removing and inserting a fiber cable from/to the Sensor Controller (Including the initial connection).
- When extending a fiber cable.

The calibration data is stored inside the Sensor Controller. Therefore, if the sensor head is calibrated once, as long as the fiber connection state does not change (if it is not disconnected from or connected to the Sensor Controller or an extension added), this operation is not needed each time.

The Sensor Head should be calibrated without any object within the measuring range or with the tip of the Sensor Head shielded from light with an object with diffuse reflection.

(Correct calibration is not possible with a transparent object, semi-transparent object, or mirror.)

- Without any object within the measuring range
- With light shielded

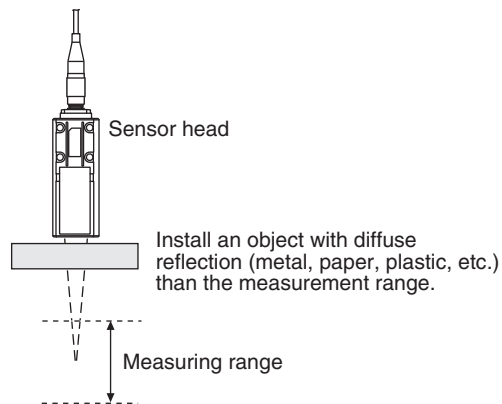
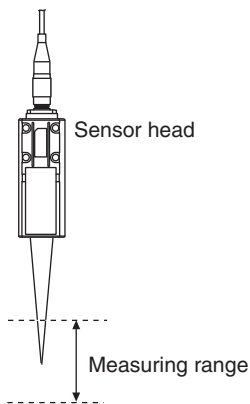

1 Set the operation mode to FUN mode.

 3-3 Switching operation modes p.57



- ▶ Explorer pane : [Device Group] | [(Sensor Name)] | [System] | [System Data] (double click)
→ Edit pane: [Sensor Settings] icon ()

2 Click [Sensor head calibration] - [Execute sensor head calibration].

Sensor head calibration is executed.

Important

When Sensor Head calibration fails

If the Sensor Head is calibrated in an inappropriate environment, an error is displayed on the main display. If this happens, check the environment and try again. If an error continues even after calibrating the Sensor Head in an appropriate environment, the fiber connector on the Sensor Head or Sensor Controller may be stained. Clean the fiber cable or fiber connector referring to p.35.

Note

Calibrating Sensor Head can also be set by the operating keys on the Sensor Controller.



Calibrating Sensor Head p.262

2-4 Wiring

20-pole terminal block

Used for judgment output, control input, etc.

Compatible cable specifications: AWG 18 to 28, pin processed length: 7 mm

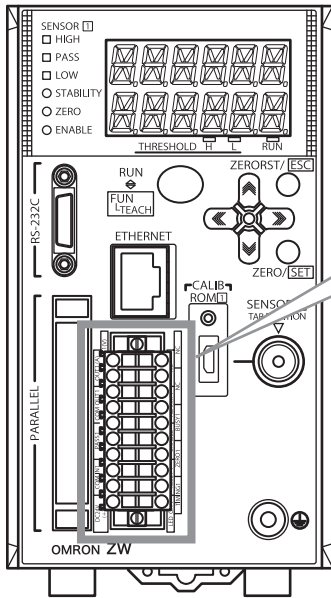

Signal name	No.	Signal name
OUT1 (V)	1 11	NC
OUT1 (A)	2 12	NC
OUT1 0V	3 13	NC
COM_OUT1	4 14	ALARM
HIGH1	5 15	BUSY1
PASS1	6 16	ENABLE1
LOW1	7 17	ZERO1
COM_IN1	8 18	RESET1
24 VDC (+)	9 19	TIMING1
24 VDC (-)	10 20	LED OFF1

Important

- Wire the power supply separate from other devices. Wiring together with other devices or using the same duct could cause a false operation or damage the sensor.
- Do not turn off the power during initial processing immediately after the Sensor Controller power is turned on, as the memory inside the Sensor Controller is being accessed. This may corrupt the data.
- Cut the unnecessary signal lines so that they do not touch other signal lines.
- The length of Cables should be less than 30 m.

Class	Name	Description
Parallel output	HIGH output	This outputs judgment results - HIGH (HIGH threshold values < Measured value).
	PASS output	This outputs judgment results - PASS (LOW threshold values ≤ Measured value ≤ HIGH threshold values).
	LOW output	This outputs judgment results - LOW (LOW threshold values > Measured value).
	ALARM output	This turns ON when there is a system error.
	BUSY output	This turns ON during sampling with the hold function enabled. It allows you to check whether or not the self-trigger is functioning correctly. It also turns ON during bank switching.
	ENABLE output	This turns ON when the sensor is ready for measurement. This output is interlocked with the ENABLE indicator.
Parallel input	ZERO input	This is used to execute and clear a zero reset.
	RESET input	This resets all executing measurements and outputs. While a RESET is being input, judgment output conforms to the non-measurement setting. If this RESET input switches ON while the hold function is used, the state in effect before the hold function was set will be restored.
	TIMING input	This is a signal input from an external device that is used to time the hold function with the continuous measurement function enabled. This is a signal input from an external device that is used to time the measurement with the trigger measurement function enabled.
	LED OFF input	This LED-OFF signal puts out the measurement LED. While LED-OFF is being input, the analog output, binary output, and judgment output conform to the non-measurement setting.
Analog output	OUT1 (V)	This outputs the measured value, from -10 V to +10 V as the voltage value. When measurement not possible: Approx. +10.8 V (default value; can be selected by user) Alarm: Approx. 10.8 V
	OUT1 (A)	This outputs the measured value, from 4 mA to 20 mA as the current value. When measurement not possible: Approx. +21mA (default value; can be selected by user) Alarm: Approx. +21 mA
	OUT1 0V	0 V for analog voltage output.
Power Supply	24 VDC (+)	Terminal for external power supply (24 V)
	24 VDC (-)	Terminal for external power supply (0 V)

- 1 Loosen the two fixing screws using a screwdriver to remove 20-pole terminal block from the Sensor Controller.

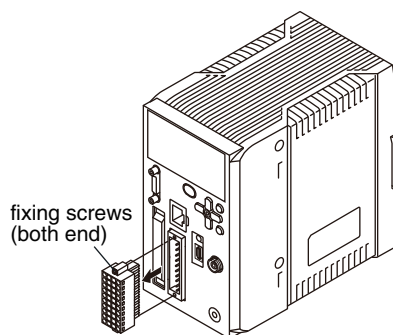

- 2 Push in and hold the release button next to the terminal hole using a screwdriver while pushing the wire fully into the terminal hole and remove the screwdriver.**

After the connection has been established, pull the wire gently, to make sure that the connection has been made securely.

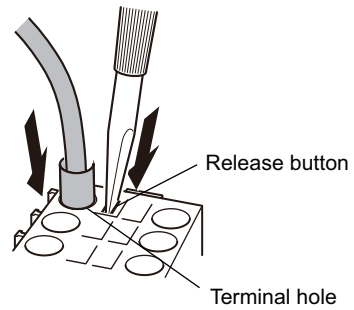

- 3 Reinstall the 20-pole terminal block to the Sensor Controller.**

Connecting Sensor Controller power supply

- 1 Connects 24 VDC power supply to terminals 9 and 10 on the 20-pole terminal block.**

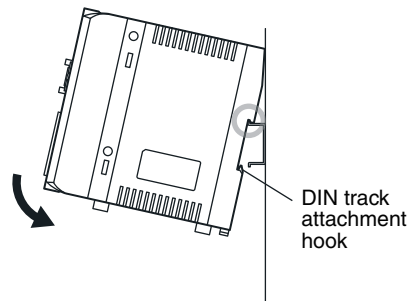

Important

When connecting the power supply, be sure to adhere to the following requirements:

- For the power supply, use AWG18 to 28 cables.
- Make the cable tip exposed by approx. 7 mm.

Note

The following product is recommended for the 24 VDC power supply:
S8VS-06024 (Omron, 2.5 A, 60 W)

52-pole extension connector

Used for bank number selection input, binary output object task selection input, binary output, etc.

Compatible connector: FX2B series (Hirose Electric Co., Ltd.)

A parallel cable (ZW-XCP2) for an extension connector with 2 m cable is available. (See p.302)

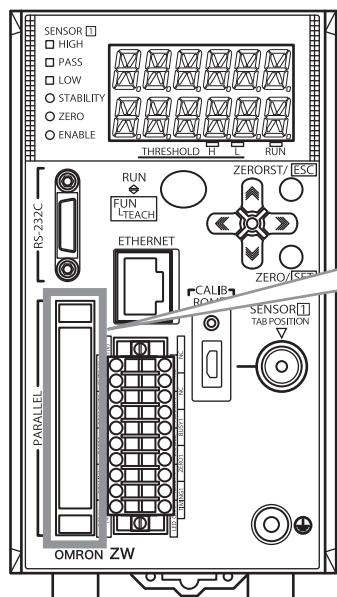

Color ^(*1)	Signal name	No. ^(*2)		Signal name	Color ^(*1)
Brown	BINARY20	A1	B1	BANK_OUT3	Brown
Red	BINARY19	A2	B2	BANK_OUT2	Red
Orange	BINARY18	A3	B3	BANK_OUT1	Orange
Yellow	BINARY17	A4	B4	NC	Yellow
Green	BINARY16	A5	B5	BINARY_OUT2	Green
Blue	BINARY15	A6	B6	BINARY_OUT1	Blue
Purple	BINARY14	A7	B7	NC	Purple
Gray	BINARY13	A8	B8	NC	Gray
White	BINARY12	A9	B9	NC	White
Black	BINARY11	A10	B10	NC	Black
Brown	BINARY10	A11	B11	NC	Brown
Red	COM_OUT4	A12	B12	COM_OUT2	Red
Orange	COM_OUT4	A13	B13	COM_OUT2	Orange
Yellow	BINARY9	A14	B14	LOGGING	Yellow
Green	BINARY8	A15	B15	NC	Green
Blue	BINARY7	A16	B16	BINARY_SEL2	Blue
Purple	BINARY6	A17	B17	BINARY_SEL1	Purple
Gray	BINARY5	A18	B18	BANK_SEL3	Gray
White	BINARY4	A19	B19	BANK_SEL2	White
Black	BINARY3	A20	B20	BANK_SEL1	Black
Brown	BINARY2	A21	B21	NC	Brown
Red	BINARY1	A22	B22	NC	Red
Orange	BINARY0	A23	B23	NC	Orange
Yellow	GATE	A24	B24	NC	Yellow
Green	COM_OUT3	A25	B25	COM_IN2	Green
Blue	COM_OUT3	A26	B26	COM_IN2	Blue

*1 Indicates ZW-XCP2 code color

*2 This is the layout for when the 52-pole extension connector on the Sensor Controller is viewed from front.

Important

Cut the unnecessary signal lines so that they do not touch other signal lines.

Class	Name	Description																																				
Parallel output	BANK_OUT output	<p>This outputs the currently specified bank number. It expresses the bank number in combinations of BANK_OUT1, 2 and 3.</p> <table border="1"> <thead> <tr> <th>Bank Number</th> <th>BANK_OUT1</th> <th>BANK_OUT2</th> <th>BANK_OUT3</th> </tr> </thead> <tbody> <tr> <td>BANK1</td> <td>OFF</td> <td>OFF</td> <td>OFF</td> </tr> <tr> <td>BANK2</td> <td>ON</td> <td>OFF</td> <td>OFF</td> </tr> <tr> <td>BANK3</td> <td>OFF</td> <td>ON</td> <td>OFF</td> </tr> <tr> <td>BANK4</td> <td>ON</td> <td>ON</td> <td>OFF</td> </tr> <tr> <td>BANK5</td> <td>OFF</td> <td>OFF</td> <td>ON</td> </tr> <tr> <td>BANK6</td> <td>ON</td> <td>OFF</td> <td>ON</td> </tr> <tr> <td>BANK7</td> <td>OFF</td> <td>ON</td> <td>ON</td> </tr> <tr> <td>BANK8</td> <td>ON</td> <td>ON</td> <td>ON</td> </tr> </tbody> </table>	Bank Number	BANK_OUT1	BANK_OUT2	BANK_OUT3	BANK1	OFF	OFF	OFF	BANK2	ON	OFF	OFF	BANK3	OFF	ON	OFF	BANK4	ON	ON	OFF	BANK5	OFF	OFF	ON	BANK6	ON	OFF	ON	BANK7	OFF	ON	ON	BANK8	ON	ON	ON
		Bank Number	BANK_OUT1	BANK_OUT2	BANK_OUT3																																	
		BANK1	OFF	OFF	OFF																																	
		BANK2	ON	OFF	OFF																																	
BANK3	OFF	ON	OFF																																			
BANK4	ON	ON	OFF																																			
BANK5	OFF	OFF	ON																																			
BANK6	ON	OFF	ON																																			
BANK7	OFF	ON	ON																																			
BANK8	ON	ON	ON																																			
BINARY output	<p>This outputs the measurement result or judgment value as binary. The measured value is output converted to 21 bits of binary data. All the task judgment results can be output together.</p>																																					
BINARY_OUT output	<p>This outputs the task number currently output as binary. It expresses the task number in combinations of BINARY_OUT1 and 2.</p> <table border="1"> <thead> <tr> <th>Task Number</th> <th>BINARY_OUT1</th> <th>BINARY_OUT2</th> </tr> </thead> <tbody> <tr> <td>TASK1</td> <td>OFF</td> <td>OFF</td> </tr> <tr> <td>TASK2</td> <td>ON</td> <td>OFF</td> </tr> <tr> <td>TASK3</td> <td>OFF</td> <td>ON</td> </tr> <tr> <td>TASK4</td> <td>ON</td> <td>ON</td> </tr> </tbody> </table>	Task Number	BINARY_OUT1	BINARY_OUT2	TASK1	OFF	OFF	TASK2	ON	OFF	TASK3	OFF	ON	TASK4	ON	ON																						
Task Number	BINARY_OUT1	BINARY_OUT2																																				
TASK1	OFF	OFF																																				
TASK2	ON	OFF																																				
TASK3	OFF	ON																																				
TASK4	ON	ON																																				
GATE output	<p>This is the timing signal for taking in binary data with external devices. When the GATE signal is ON, take in the binary data.</p>																																					

Class	Name	Description																																			
Parallel input	BINARY_SEL input	<p>This selects which task's data is output as binary. Specify the task number in combinations of BINARY_SEL1 and 2. It is only enabled in RUN mode.</p> <table border="1"> <thead> <tr> <th>Task Number</th> <th>BINARY_SEL1</th> <th>BINARY_SEL2</th> </tr> </thead> <tbody> <tr> <td>TASK1</td> <td>OFF</td> <td>OFF</td> </tr> <tr> <td>TASK2</td> <td>ON</td> <td>OFF</td> </tr> <tr> <td>TASK3</td> <td>OFF</td> <td>ON</td> </tr> <tr> <td>TASK4</td> <td>ON</td> <td>ON</td> </tr> </tbody> </table>	Task Number	BINARY_SEL1	BINARY_SEL2	TASK1	OFF	OFF	TASK2	ON	OFF	TASK3	OFF	ON	TASK4	ON	ON																				
	Task Number	BINARY_SEL1	BINARY_SEL2																																		
	TASK1	OFF	OFF																																		
TASK2	ON	OFF																																			
TASK3	OFF	ON																																			
TASK4	ON	ON																																			
BANK_SEL input	<p>This is used for switching banks. Specify the bank number in combinations of BANK_SEL1, 2 and 3. However, if the bank mode is set to "JUDGEMENT", the bank cannot be switched at the external signal input because the number of banks increases to 32.</p> <table border="1"> <thead> <tr> <th>Bank Number</th> <th>BANK_SEL1</th> <th>BANK_SEL2</th> <th>BANK_SEL3</th> </tr> </thead> <tbody> <tr> <td>BANK1</td> <td>OFF</td> <td>OFF</td> <td>OFF</td> </tr> <tr> <td>BANK2</td> <td>ON</td> <td>OFF</td> <td>OFF</td> </tr> <tr> <td>BANK3</td> <td>OFF</td> <td>ON</td> <td>OFF</td> </tr> <tr> <td>BANK4</td> <td>ON</td> <td>ON</td> <td>OFF</td> </tr> <tr> <td>BANK5</td> <td>OFF</td> <td>OFF</td> <td>ON</td> </tr> <tr> <td>BANK6</td> <td>ON</td> <td>OFF</td> <td>ON</td> </tr> <tr> <td>BANK7</td> <td>OFF</td> <td>ON</td> <td>ON</td> </tr> <tr> <td>BANK8</td> <td>ON</td> <td>ON</td> <td>ON</td> </tr> </tbody> </table>	Bank Number	BANK_SEL1	BANK_SEL2	BANK_SEL3	BANK1	OFF	OFF	OFF	BANK2	ON	OFF	OFF	BANK3	OFF	ON	OFF	BANK4	ON	ON	OFF	BANK5	OFF	OFF	ON	BANK6	ON	OFF	ON	BANK7	OFF	ON	ON	BANK8	ON	ON	ON
Bank Number	BANK_SEL1	BANK_SEL2	BANK_SEL3																																		
BANK1	OFF	OFF	OFF																																		
BANK2	ON	OFF	OFF																																		
BANK3	OFF	ON	OFF																																		
BANK4	ON	ON	OFF																																		
BANK5	OFF	OFF	ON																																		
BANK6	ON	OFF	ON																																		
BANK7	OFF	ON	ON																																		
BANK8	ON	ON	ON																																		
LOGGING input	<p>This is used to start and end internal logging.</p>																																				

Electrical Specifications

Input circuit

Item	Specifications	
Model	ZW-C10T/C10AT	ZW-C15T/C15AT
Input type	NPN	PNP
Input voltage	DC24 V \pm 10 % (21.6 to 26.4 V)	DC24 V \pm 10 % (21.6 to 26.4 V)
Input current	7 mA Typ. (DC24 V)	7 mA Typ. (DC24 V)
ON voltage/ON current *1	19 V min./3 mA min.	19 V min./3 mA min.
OFF voltage/OFF current *2	5 V max./1 mA max.	5 V max./1 mA max.
ON delay	0.1 ms max.	0.1 ms max.
OFF delay	0.1 ms max.	0.1 ms max.
Internal circuit diagram *3		

*1 ON voltage/ON current

This is the voltage value or current value that makes the signal go OFF to ON.

The ON voltage value becomes the potential difference between COM IN 1/2 and the input terminals.

*2 OFF voltage/OFF current

This is the voltage value or current value that makes the signal go ON to OFF.

The OFF voltage value becomes the potential difference between COM IN 1/2 and the input terminals.

*3 Below is a table giving the COM_IN (input common) and input signal connection correspondence.

Terminal name	20-pole terminal block COM_IN1	52-pole extension connector COM_IN2
Input terminal name	ZERO1	BANK_SEL1
	RESET1	BANK_SEL2
	TIMING1	BANK_SEL3
	LED OFF1	BINARY_SEL1
		BINARY_SEL2
		LOGGING

Important

Chattering countermeasures

- The sensor is designed with functions to deal with chattering, but if chattering of 100 μ s or more occurs, incorrect input due to chattering cannot be prevented. (Input signal changes of less than 100 μ s are ignored. The input signal is applied when the same level is maintained for 100 μ s or longer.)
- Always use non-contact relays (SSR, PLC transistor output) for input signals. If contact relays are used, contact bouncing may turn ON a TIMING input again during measuring.

Output circuit

Item	Specifications	
Model	ZW-C10T/C10AT	ZW-C15T/C15AT
Output type	NPN	PNP
Output voltage	DC21.6 to 30 V	
Load current	20-pole terminal block: 50 mA max. 52-pole extension connector: 30 mA max.	20-pole terminal block: 50 mA max. 52-pole extension connector: 30 mA max.
ON residual voltage	1.2 V max.	
ON leakage current	0.1 mA max.	
Internal circuit diagram *1		

*1 Below is a table giving the COM_OUT (output common) and output signal connection correspondence.

Terminal name	20-pole terminal block		52-pole extension connector	
	COM_OUT1	COM_OUT2	COM_OUT3	COM_OUT4
Output terminal name	HIGH1	BANK_OUT1	GATE	BINARY10
	PASS1	BANK_OUT2	BINARY0	BINARY11
	LOW1	BANK_OUT1	BINARY1	BINARY12
	ALARM	BANK_OUT2	BINARY2	BINARY13
	BUSY1	BANK_OUT3	BINARY3	BINARY14
	ENABLE1		BINARY4	BINARY15
			BINARY5	BINARY16
			BINARY6	BINARY17
			BINARY7	BINARY18
			BINARY8	BINARY19
		BINARY9	BINARY20	

Important

- Connect a load that matches the output specifications. Short-circuit can cause sensor breakdown.
- Keep the load current less than or equal to the specification value. Exceeding the specification value could cause damage to the output circuit.

2-5 Installing the Sysmac Studio

The PC Tool used to set up ZW-series Displacement Sensors is installed from the Sysmac Studio Installer. Refer to the *Sysmac Studio Version 1 Operation Manual* (Cat. No. W504) for the system requirements and installation procedure.

Basic Operation

3-1 Launching a project	50
3-2 Explanation of Screen Sections	52
3-3 Switching operation modes	57
3-4 Bank switching	58
3-5 Perform the Zero Reset	61
3-6 Setting Threshold Value	64
3-7 Saving a project	66
3-8 Operating with Sensor Controller	67

3-1 Launching a project

Connecting to the sensor with PC tool

Creating a new project

Create a new project, add a sensor to the project, then start communicating with the sensor.

1 Start up the PC tool.

2 Create a new project.

Click [New Project] and select [Displacement Sensor] from [Category] under [Select Device], and [ZW] from [Device].

Then enter [Project name], [Author], and [Comment].

Click [Create] to create a blank project.

Note

If there are existing projects, click [Open Project]. A list of the projects is displayed. Select the project you want to open and click [Open]. If an existing project is opened, it starts up in offline mode. For the details of offline mode, see below.

 Chapter 7 Offline Settings p.203

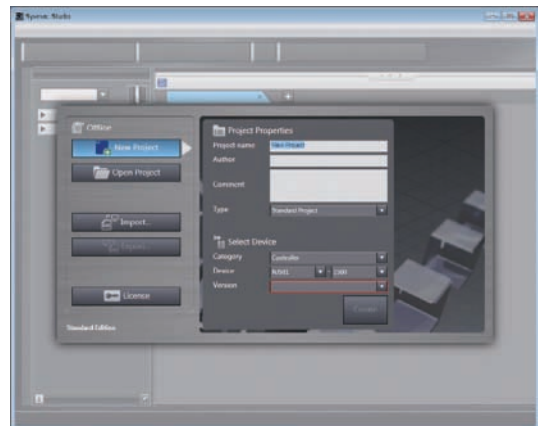

3 Specify the sensor to connect using one of the methods below.

- Directly specify the IP address of the sensor to connect.
Check the [Specify a sensor] box. Then, directly enter the IP address and click [OK].
For the default value of the IP address, refer to p.170.
- When not connected with the sensor (offline)
When setting a project offline without connecting to the actual sensor, check [Enter the type] to select.
Then, select the sensor model and software version to use and click [OK].

 Chapter7 Offline Settings p.203

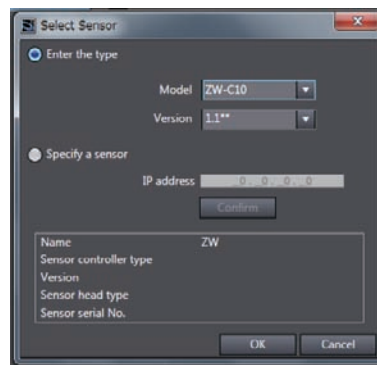

4 After the sensor is connected, the following window appears.

The Main pane appears on the Edit pane. The sensor starts up in RUN mode.

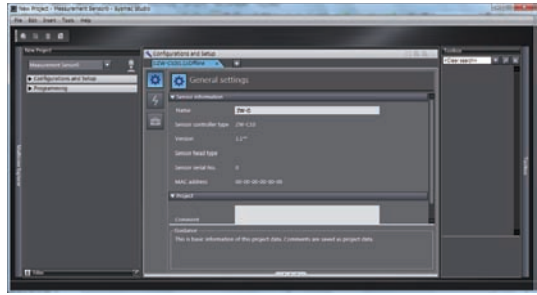

Adding a sensor to a project

After the project is created, additional sensors can be added to the project.

- **Explorer pane** : [Device Group] (right click) | [Add]

Entering project information

Comments about the project can be entered.

- **Explorer pane** : [Device Group] | [(Sensor Name)] (double click)
→ **Edit pane** : [General Settings] icon (⚙️)

- 1** Enter comments for the project in the [Comment] field.

3-2 Explanation of Screen Sections

PC tool

The following summarizes the names and functions of the window sections of Sysmac Studio.

Sysmac Studio Main window

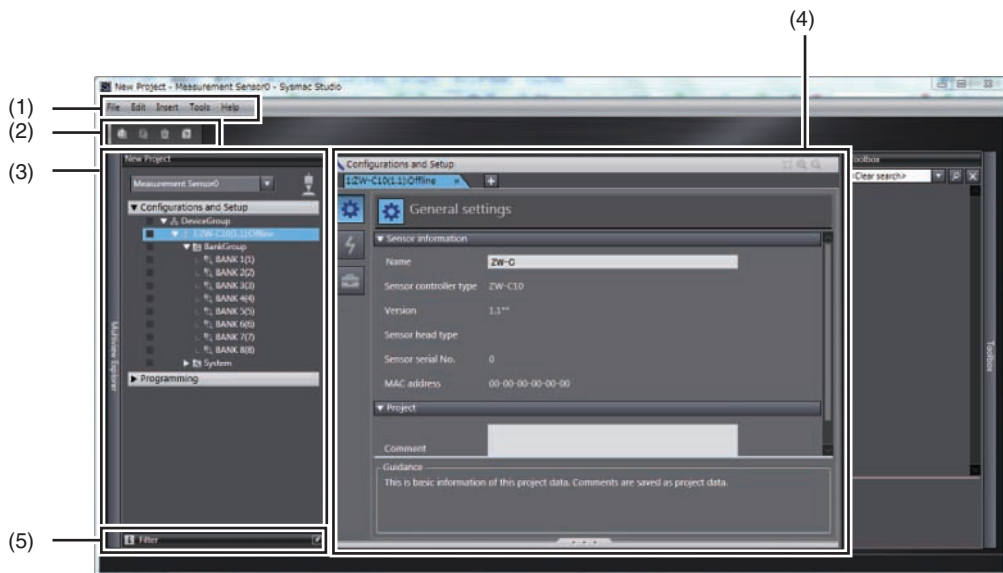

No.	Name	Description
(1)	Menu bar	Menu items that can be used with this tool is displayed.
(2)	Toolbar	Tool functions that can be used with this tool is displayed with icons.
(3)	Explorer pane	Displays the data hierarchy of the sensor with a hierarchy tree. Double clicking each data displays Main pane, Bank data edit pane, and System data edit pane on the Edit pane.
(4)	Edit pane	Edits and displays data selected in the Explorer pane. It mainly consists of Menu icon, Line bright monitor, setting items, and properties.
(5)	Status bar	Displays the status of setting operations.

Explorer pane

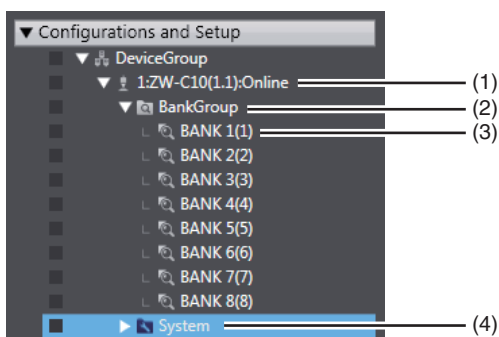

No.	Name	Description
(1)	Sensor model	Displays the sensor model. Displays online/offline status at the end.
(2)	Bank group	This is a group of bank data. Bank data can be registered up to 8 in NORMAL mode, and up to 32 in JUDGMENT VALUE BANK mode.
(3)	Bank data	This is used to set functions to perform measurements. It consists of sensing setting, task setting, and I/O setting.
(4)	System data	System data common to all banks.

A list of menu items displayed with right click

Tree view items	Menu	Description
Device group	Add ZW-C	Adds a sensor to the project.
	Paste	Pastes the copied sensor to the project.
	Rename	Changes the device group name.
Sensor model	Edit	Displays the main pane as the Edit pane.
	Delete	Deletes a sensor from the project.
	Copy	Copies a sensor.
	Online	Switches the connection status with the sensor to online.
	Offline	Switches the connection status with the sensor to offline.
	RUN	Switches the sensor to RUN mode.
	Setup	Switches the sensor to Setup mode.
	Save settings	Save the sensor settings data to nonvolatile memory.
	Initialize Sensor	Initialize the sensor.
	Restart	Restart the sensor.
Bank data	Print	Setting data is printed.
	Edit	Displays the bank data edit pane as the Edit pane.
	Copy	Copies a bank data.
	Paste	Overwrites the copied bank data.
	Initialize	Deletes (initializes) bank data.
System data	Rename	Changes the bank data name.
	Edit	Displays the system data edit pane as the Edit pane.
	Copy	Copies system data.
	Paste	Overwrites system data.

Edit pane



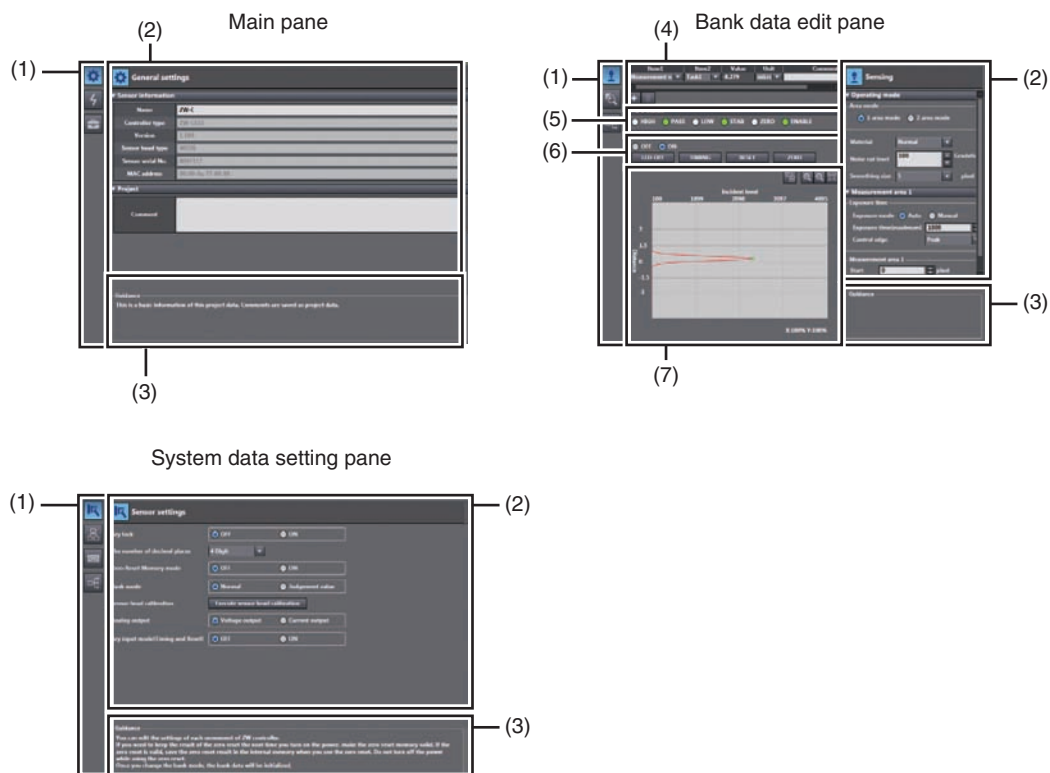







The Edit Pane changes as shown below based on what is selected in the Explorer Pane.



No.	Name	Description
(1)	Menu icon	Parameters to be edited on each edit pane can be changed.
(2)	Setting item	When editing each menu item selected with menu icons, a pop up window is called out.
(3)	Guidance	The description of the focused setting item is displayed.
(4)	Measurement value monitor	The selected measurement results or output values are displayed.
(5)	LED light	The status of each LED light is displayed when online.
(6)	I/O input	The status of I/O signals can be switched when online.
(7)	Line bright monitor	The line bright is displayed.

List of icons





(1) Menu icon

Edit pane type	Icon	Menu name	Description
Main pane		General settings	Sensor name and project information can be checked.
		Online	Switching between online and offline connections with the actual sensors, and switching the operating mode can be performed. Also, the internal logging process, saving set data, monitoring the measurement results can be performed.
		Tool	The initialization or upgrading the version of the actual sensor can be performed.
Bank data edit pane		Sensing	Switching the operation mode (1 area/2 area), and setting exposure time and measurement areas can be performed.
		Task 1	Allows you to perform setting to calculate the feature amounts of height, thickness and calculation using scaling, filter, and hold processes. Settings can be made individually for the task 1 to 4.
		I/O	Allow you to make settings for judgment output, and analog output.
System data setting pane		Sensor settings	Allows you to make sensor settings such as bank mode or analog output.
		Ethernet communication settings	Allows you to make settings for Ethernet communication.
		RS-232C communication settings	Allows you to make settings for RS-232C communication settings.
		Data output settings	Edit the data output settings.

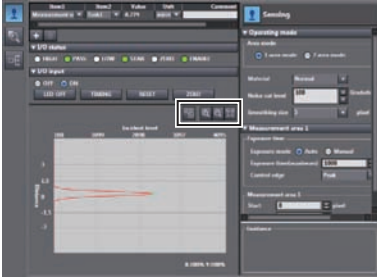
(2) Operation icons







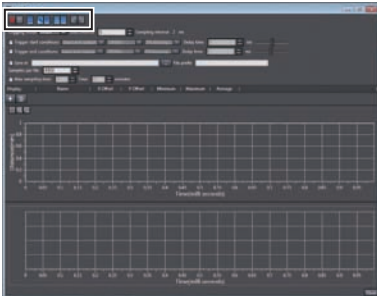

Bank data edit pane



Icon	Name	Description
	Zoom in	Zoom in the line bright.
	Zoom out	Zoom out the line bright.
	Fit to frame	Change the size of the line bright so it fits the window size.
	Export	Saves the line bright being displayed.

Trend monitor window



Icon	Name	Description
	Start sampling	Starts the sampling.
	Stop sampling	Stops the sampling.
	Show grid	Displays gridlines.
	Show configuration	Displays the logging condition setting window.
	Show data table	Displays the data window to be logged.
	Show Analog Chart	Displays the analog chart window.
	Show Digital Chart	Displays the digital chart window.
	Import	Imports the exported measurement results and display them on each chart.
	Export	Exports the measurement results displayed on each chart.

3-3 Switching operation modes

The Sensor Controller has two operation modes. One is RUN mode and the other is FUN mode. Switch to the desired mode depending on purpose.

(The Sensor Controller always starts up in the RUN mode when the power is turned on.)

Item	Setting item	Mode	Description
Online	Operation mode	RUN	Switches to RUN (operation) mode. Normal operation mode.
		Setup	Switches to Setup mode. Mode for setting the measurement conditions.

- ▶ **Explorer pane** : [Device Group] | [(Sensor Name)] (double click)
- **Edit pane** : [Online] icon (⚡)

1 Select the operation mode with [Operation mode].

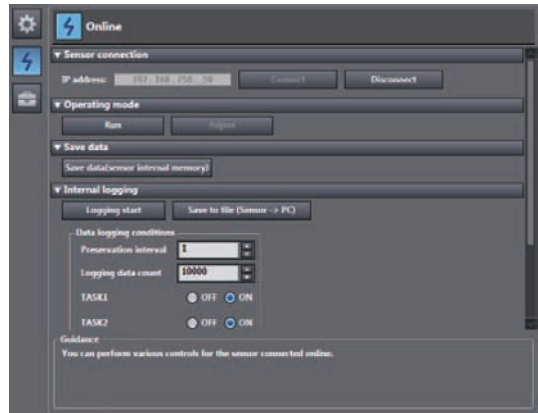

Note

Switching operation modes can also be set by the operating keys on the Sensor Controller.

9-4 Switching operation modes p.222

3-4 Bank switching

Multi-task and Bank Data

Multi-task Function

With the ZW Series, you can set multiple measurement processing for one sensing setting. This measurement processing is called a "task (TASK)."

Example: When measuring height and side run-out at the same time

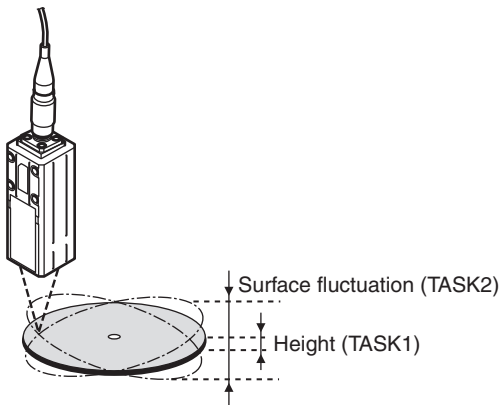

For tasks, TASK1 to TASK4 are available for registration.

You can measure and judge up to four characteristic points simultaneously because you can specify the desired measurement items such as peak, bottom, and average for each task.

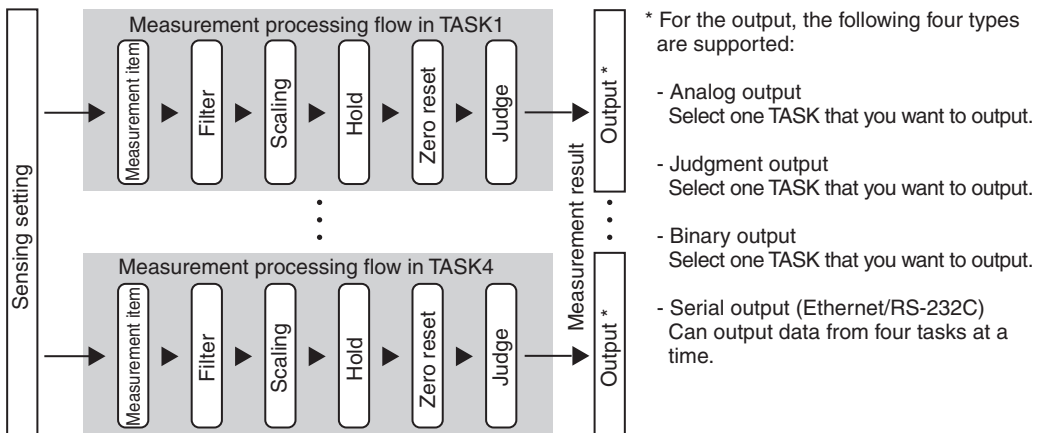

Bank Data

ZW series can hold up to eight sets of sensing settings, which are called "bank (BANK)". When the setup is changed, the bank can be switched externally.

What is Bank?

The sensing settings for measurement



are held as one bank.

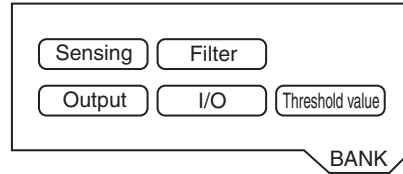

Example of switching bank for settings

If you register settings of various classes,

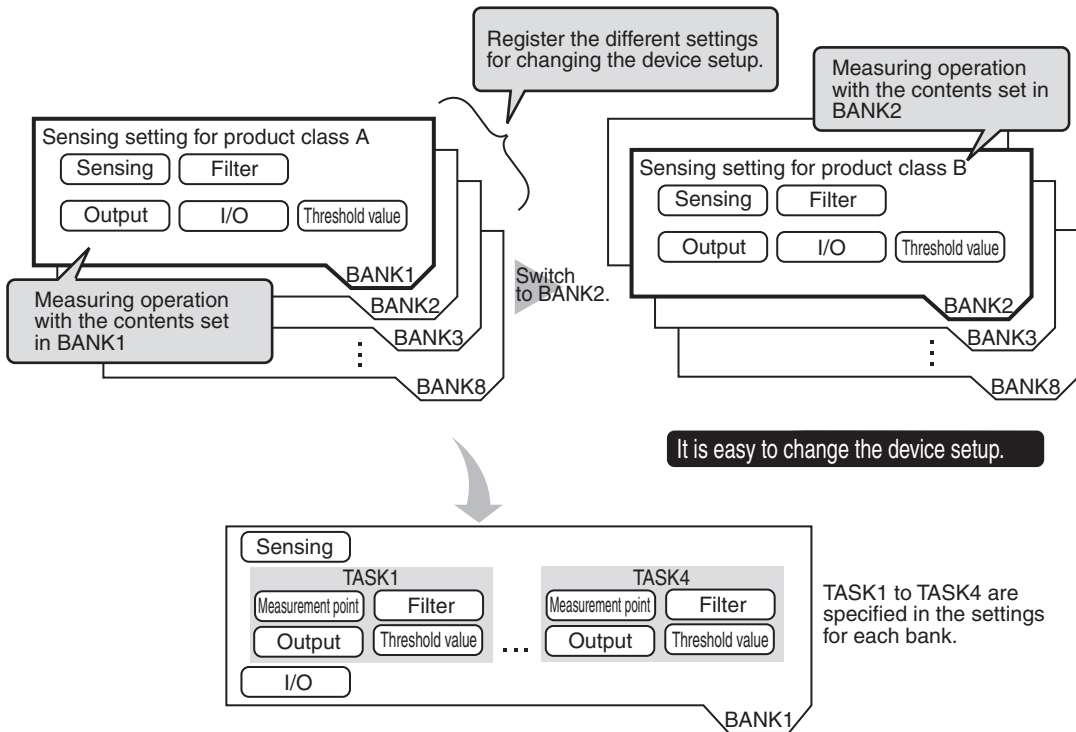

Important

- If you want to register multiple bank data having the same values set except for "threshold values (judgment values)", by changing the mode of the bank, you can increase the number of banks from 8 to 32.

Changing the Bank Mode p.106

- The "output destination" (current output value/voltage output value) in the I/O setting parameters is set the same for all banks. The output destination cannot be set separately for individual banks.

Setting the analog output destination p.138

Switching Banks

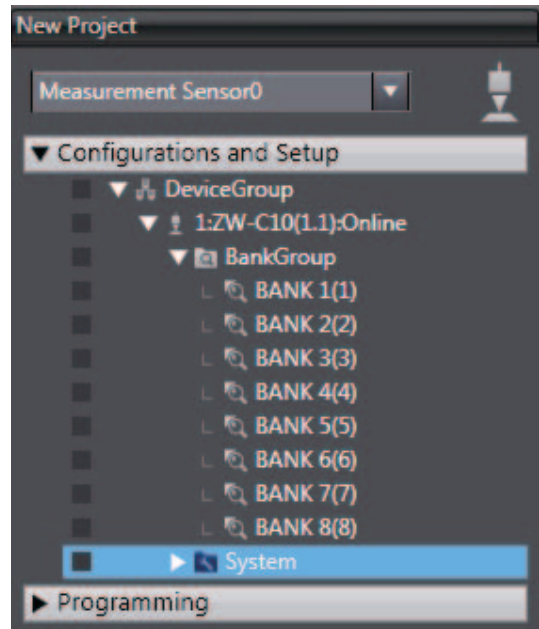

Switches banks.

- 1** Click the bank group on the Explorer pane to open.
- 2** Select the bank data to switch and double click or right click it to select the Edit menu. The bank in the Bank data edit pane that is active on the Edit pane becomes the current bank.



Important

You can also switch the bank by entering the non-procedural command or from SmartMonitor ZW.

-  Current bank data setting command <BS command> p.185
-  *SmartMonitor ZW Operation Manual*

Note

Switching Banks can also be set by the operating keys on the Sensor Controller.

-  Switching Banks p.252

3-5 Perform the Zero Reset

Zero reset

What is Zero Reset?

This function allows resetting the measured value to "0" at any timing during measurement in the RUN mode. The measured value can be displayed and output as a positive or negative deviation (tolerance) from the set reference value "0".

Example 1: Use the height of the sensing object as a reference value and the deviation is the measured value.

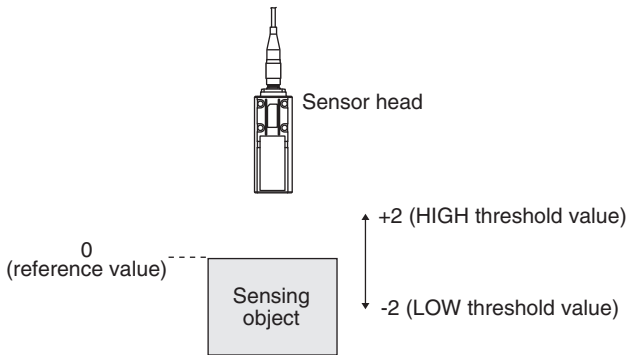

Example 2: Use the measured value according to the height of the sensing object (set 10 as an offset value)

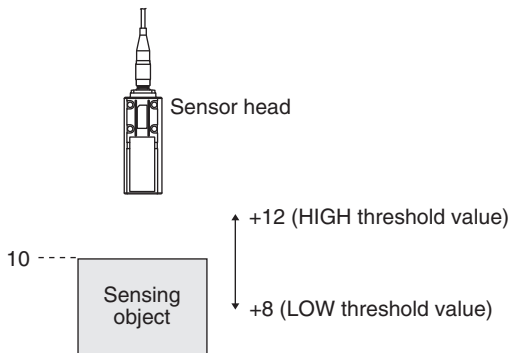

Example 3: Measure the level difference of the sensing object (execute zero reset at every measurement)

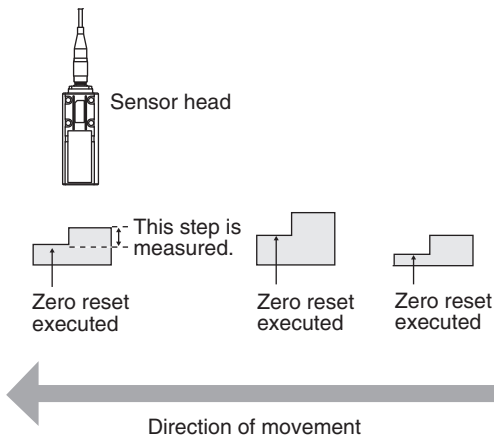

The zero reset function also allows setting the reference value to the hold value for a hold measurement or any value other than zero.

Setting the Zero Reset p.101 p.248

Executing Zero Reset

- 1 Place the reference sensing object in position.

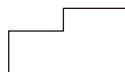

- 2 Press the key.

The ZERO indicator illuminates and the current measured value is registered as 0.

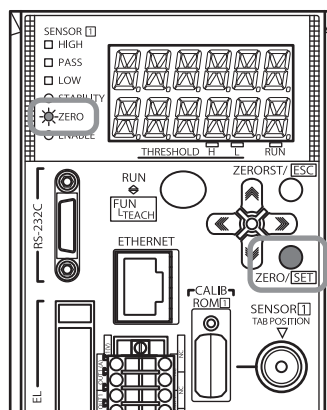



Important

- When a zero reset is executed, the analog output becomes the voltage or current value at the center of the two preset points. Analog output becomes roughly 0 V or 12 mA when focus is not set.

 Setting Monitor Focus p.140

- The Zero Reset function can also be executed by supplying a ZERO signal to the 20-pole terminal block.

 20-pole terminal block p.40

 ZERO input p.134

Canceling Zero Reset

- 1 Press and hold the  key for two seconds.

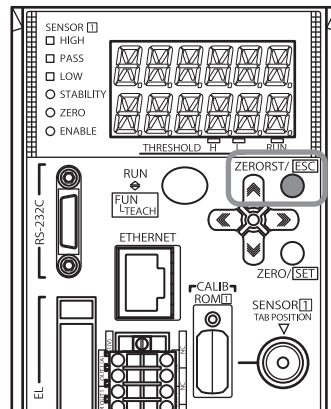
**Important**

- The Zero Reset function can also be executed by supplying a ZERO signal to the 20-pole terminal block.

 20-pole terminal block p.40

 ZERO input p.134

3-6 Setting Threshold Value

Threshold Value Settings

Switch the Sensor Controller to the FUN mode and set the range in order for the measured value to be judged as PASS.

Both HIGH and LOW threshold values are set.

As a judgment result, HIGH, PASS or LOW is output.

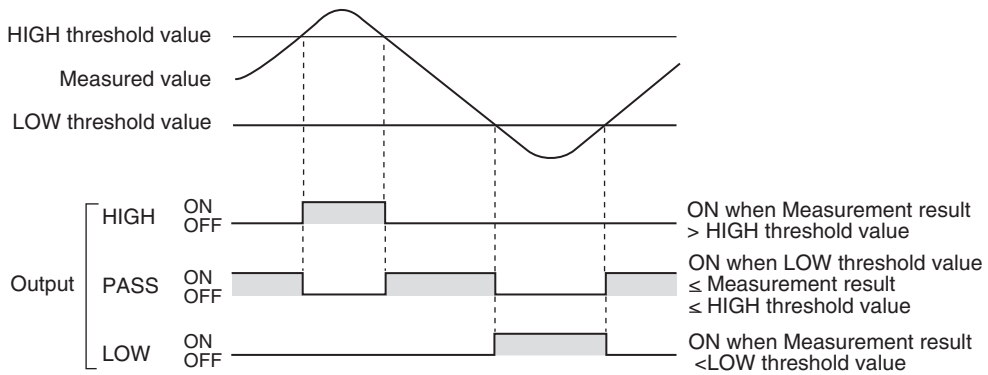

A judgment result appears on the Sensor Controller as follows.

- When the judgment result is "HIGH": HIGH indicator lights up
- When the judgment result is "PASS": PASS indicator lights up
- When the judgment result is "LOW": LOW indicator lights up

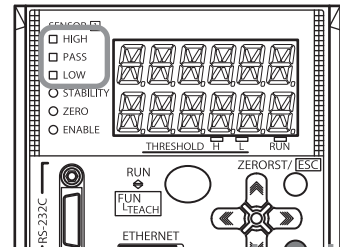

Item	Setting item	Setting value	Description
Judgment	LOW threshold	- 999.999999 to 0 (default value) to 999.999999 [mm]	Set the lower limit (LOW) threshold value.
	HIGH threshold	- 999.999999 to 0 (default value) to 999.999999 [mm]	Set the upper limit (HIGH) threshold value.

- ▶ Explorer pane : [Bank] | [(Bank Data Name)] (double click)
- Edit pane : [Task Settings] icon (🔧)
- Task settings window : [Judgment]

1 Enter the [LOW threshold] and [HIGH threshold].

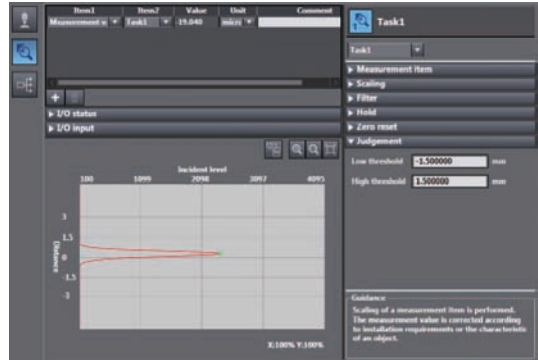

Important

- Hysteresis (hysteresis width) can also be set to threshold values. Set hysteresis when measured values are dispersed around a threshold value, and judgments are unstable, to prevent chattering.

📖 Setting Operation at Judgment Output p.144

- Threshold values can also be adjusted by directly entering values in the RUN mode. This helps you to make fine adjustments without shutting down the system.

📖 Changing Threshold Values p.227

Note

Threshold Value Settings can also be set by the operating keys on the Sensor Controller.

📖 9-10 Setting Threshold Value p.257

3-7 Saving a project

Saving a project

Save the project being edited with the PC tool.
The project to be saved has the following information.

Configuration data	Description
Project information	Information on the sensor registered in this project.
Entire sensor information	Entire sensor information.
Tool setting information	Information on tool setting parameters for each sensor registered in this project.

A project cannot be saved in RUN mode. Switch to the RUN mode to save.

Note

 3-3 Switching operation modes p.57

Important

- Save a project data when the setting of the Sensor Controller is changed. If the power is turned off without saving, the changed setting is cleared.

 Saving the Bank/System Settings p.108

1 Menu bar: Click [File] - [Save] to select.

Exporting a project

A project data (.smc) can be exported.
The exported data can be used by importing with the other personal computer's PC tool.

1 Menu bar: Click [File] - [Export] to select.

Importing a project

The exported data from other personal computers can be imported as project data.

1 Menu bar: Click [File] - [Import] to select.

3-8 Operating with Sensor Controller

Other than using PC tools, ZW Series can also be operated using the operation keys on the Sensor Controller. For details on how to operate with operation keys, see 9. Sensor controller operations (p.213).

MEMO

Settings for Function

4-1 Setting Sensing	70
4-2 Setting Measurement Items.....	79
4-3 Setting the Output Conditions	83
4-4 Setting the Banks.....	106
4-5 Setting the System.....	110

4-1 Setting Sensing

Selecting the Area Mode

Area modes can be used selectively according to the target to measure.

Item	Setting item	Setting value	Description
Operating mode	Area Mode	1 area mode	Usually, select this setting.
		2 area mode	We recommend measuring in the 2 area mode when the measurement object is a transparent object and the reflection characteristics of the target to measure are different. The sensing setting suitable for each the measurement surface can be used.

► **Explorer pane** : [Bank] | [(Bank Data Name)] (double click)
 → **Edit pane** : [Sensing setting] icon ()

1 Select the area mode at [Operating mode] - [Area mode].

Important

- When the 2 area mode is selected, [Measurement area 2] is added to the setting items for sensing setting.
- In the 2 area mode, the exposure time control mode and measurement area must each be set for [Measurement area 1] and [Measurement area 2].

 Setting Exposure Time Control Mode p.75

 Setting the Measurement Area p.76

- The measuring cycle for the 2-area measurement mode is twice as long as the one for Area 1 or 2, which is longer than the other.

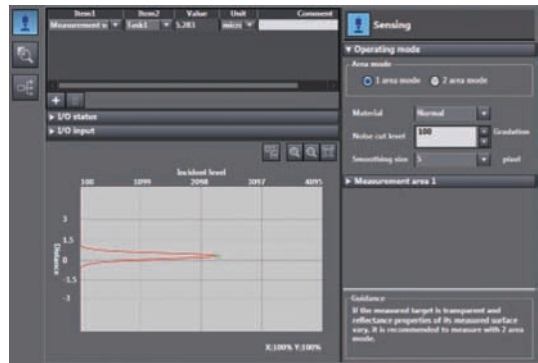

Setting the Material of the Target to Measure

Setting the material of the target to measure.

Item	Setting item	Setting value	Description
Operation mode	Material	Normal (default value)	A measurement can be performed at specific linearity regardless of the type of target to measure. Usually, select this setting.
		Mirror	Select this mode when specular reflection (regular reflection) occurs on the surface. (Glass, wafer, lustrous metal, etc.)
		Rough	Select this mode when diffuse reflection occurs on the surface.

- ▶ **Explorer pane** : [Bank] | [(Bank data name)] (double-click)
- **Edit pane** : [Sensing setting] icon ()
- **Sensing settings window** : [Operating mode]

- 1 Select the material of the target to measure at [Material].

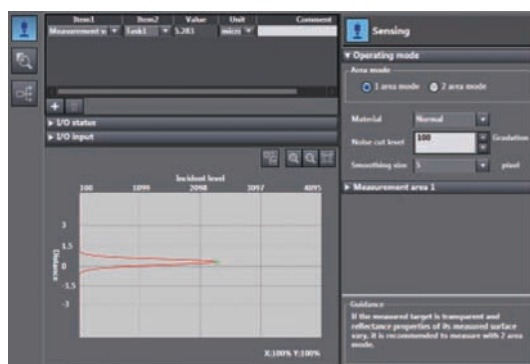

Important

Refer to p.286 for the linearity data of various materials according to each material setting.

Note

The material of the target to measure can also be set by the operating keys on the Sensor Controller.

 Setting the Material of the Target to Measure p.228

Setting the Noise Cut Level

The setting a larger value than the noise level, the noise can be cut.

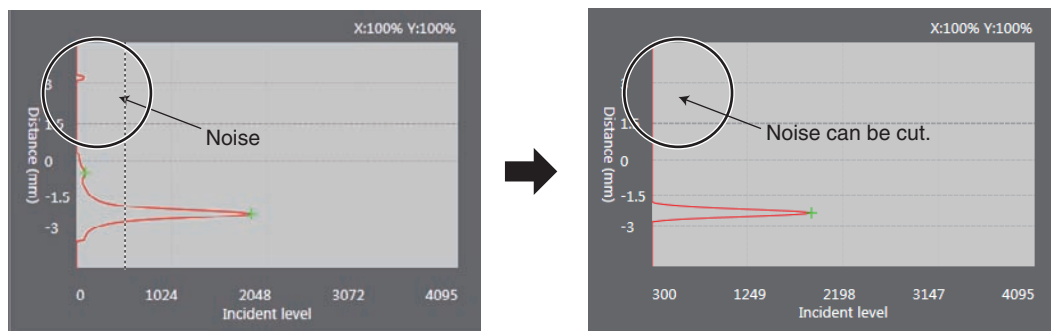

Item	Setting item	Setting value	Description
Operation mode	Noise cut level	0 to 4,095 [Gradation] (Default value :100)	Set the number of gradations when noise is cut from the line bright.

- ▶ Explorer pane : [Bank] | [(Bank Data Name)] (double click)
- Edit pane : [Sensing setting] icon ()
- Sensing settings window : [Operating mode]

1 Set [Noise cut level].

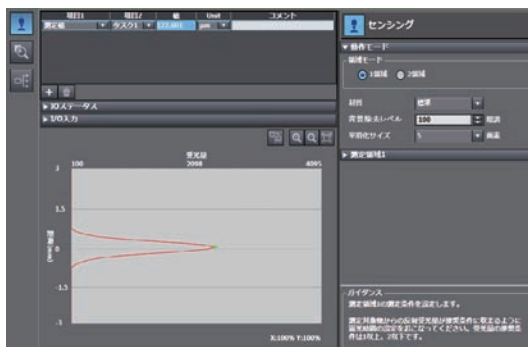

Setting Smoothing Size

When two measurement surfaces are close, the line bright may not be divided. The setting of smoothing size a smaller value, it becomes easy to divide.

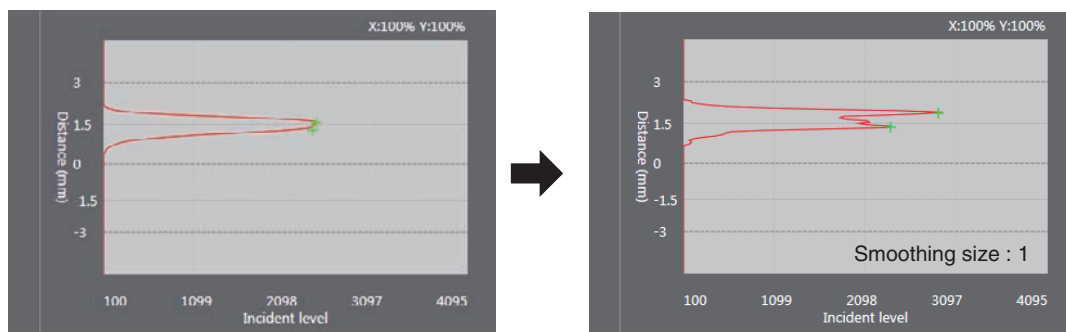

Item	Setting item	Setting value	Description
Operation mode	Smoothing size	1/3/5/7/9 [pixels] (Default value :5)	Set the pixel size to be used as the unit when smoothing the line bright.

- ▶ **Explorer pane** : [Bank] | [(Bank Data Name)] (double click)
- **Edit pane** : [Sensing setting] icon ()
- **Sensing settings window** : [Operating mode]

1 Set [Smoothing size].

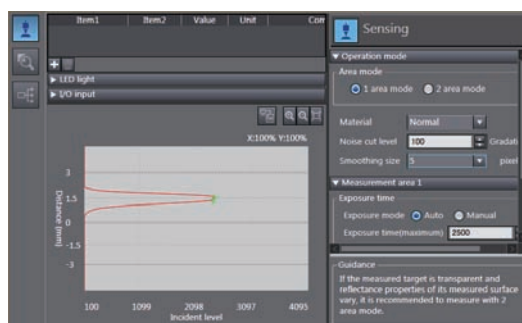

Important

Usually use the initial value, because the resolution may worsen when the setting a small value

Setting Start Direction of Count Measurement Surfaces

When a number of measurement surfaces exists, start direction can be selected from NEAR side or FAR side.

Example: NEAR

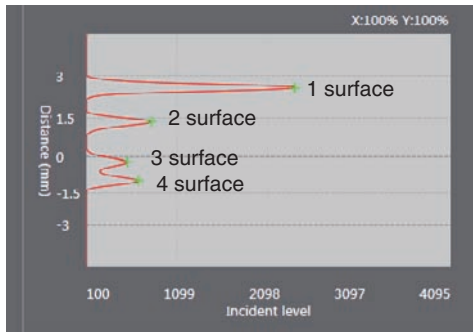

Example: FAR

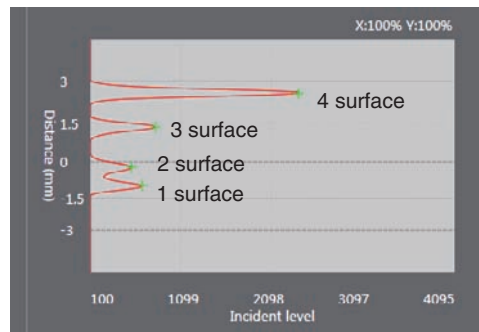

Item	Setting item	Setting value	Description
Operation mode	Start direction of count measurement surfaces	NEAR (default value)	Measurement surfaces are counted from NEAR side.
		FAR	Measurement surfaces are counted from FAR side.

Important

It cannot set and display using Sysmac Studio.

Note

The setting of start direction of count measurement surfaces can also be set by the operating keys on the Sensor Controller.



Setting Start Direction of Count Measurement Surfaces p.229

Setting Exposure Time Control Mode

Set the exposure time control mode and exposure time (maximum) or exposure time (fixed).

Item	Setting item	Setting value	Description
Exposure time	Exposure mode	Auto (default value)	Automatically sets the exposure time within the range that does not exceed the specified upper limit. Usually, select this setting.
		Manual	Select this mode when you want to specify the exposure time, and set the exposure time (fixed value).
	Exposure time (maximum)	1 to 1,000 (default value) to 5,000 [μ s]	Set the upper limit value of the exposure time when [Automatic] has been selected for the control mode.
	Exposure time (fixed)	1 to 1,000 (default value) to 5,000 [μ s]	Set the fixed value of the exposure time when [Fixed] has been selected for the control mode.
	Control edge	1 surface/2 surfaces/3 surfaces/4 surfaces/Peak (default value)	Select the measurement surface target for light adjustment. The peak is the surface of all measurement surfaces having the highest received light amount.

Important

Exposure time and measuring cycle

- For the "AUTO" exposure time control mode, the measuring cycle is twice the preset exposure time upper limit. (The measuring cycle remains the same even if the actual exposure time is the upper limit or less.)
- For the "MANUAL" exposure time control mode, the measuring cycle twice the exposure time is used.
- If the exposure time is 250 μ s or less, the measuring cycle is set to 500 μ s.

- **Explorer pane** : [Bank] | [(Bank Data Name)] (double click)
 → **Edit pane** : [Sensing setting] icon ()
 → **Sensing settings window** : [Measurement area 1] or [Measurement area 2] - [Exposure time]

- 1** Select the exposure mode from [Exposure mode].

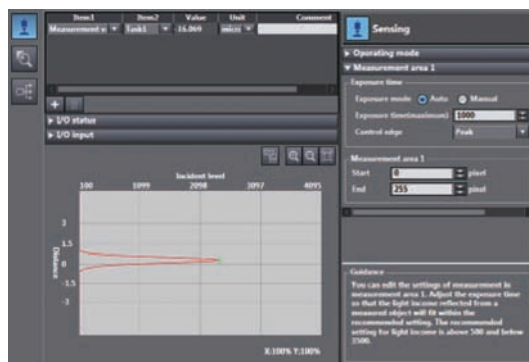

- 2** Set [Exposure time (maximum)] and [Control edge].

Note

The exposure time control mode can also be set by the operating keys on the Sensor Controller.

 Setting Exposure Time Control Mode p.230

Setting the Measurement Area

The measurement area can be limited, setting upper line and lower line of selected area.

The measurement object can be measured stably, cutting out the area that the object does not exist.

When the measurement object is set to "Glass," measurement may not be performed correctly as measurement will be influenced by reflection from the rear surface. If this happens, set the measurement area area of each measurement surface so that they can be correctly measured.

Item	Setting item	Setting value	Description
Measurement area	Upper line	Measuring range of Sensor Head [mm]	Set the measurement start position for the selected measurement area. When the window for the selected measurement area is open, the start position can also be edited by dragging the start line on the line bright monitor.
	Lower line	Measuring range of Sensor Head [mm]	Set the measurement end position for the selected measurement area. When the window for the selected measurement area is open, the end position can also be edited by dragging the end line on the line bright monitor.

- ▶ **Explorer pane** : [Bank] | [(Bank Data Name)] (double click)
- **Edit pane** : [Sensing setting] icon ()
- **Sensing settings window** : [Measurement area 1] or [Measurement area 2]

1 Set the [Upper line] and [Lower line] values at [Measurement area].

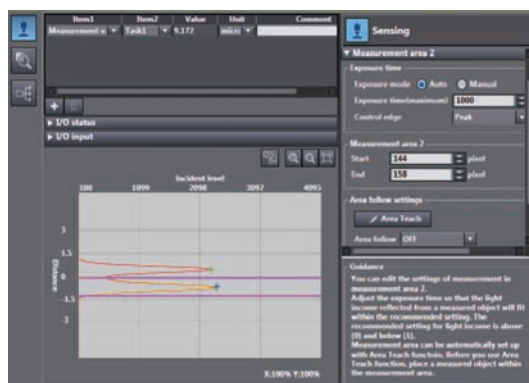

Important

- Ensure that the setting values for the measurement area satisfy the following relationship: [Start] < [End].
- To set the measurement area using any value by the above method at [Measurement area 2], set [Area follow] at [Area follow settings] to [OFF].

Automatically Following the Range of Measurement Area2

When 2 area mode is set, the measurement area 2 can be set automatically to measure the measurement surface (Follow), and the measurement area 2 range can follow the measurement surface (Base) movement.

This function is used when a few surface of vibrating object is measured stable.



Item	Setting item	Setting value	Description
Area follow settings	Area follow	OFF (default value)	Area follow is not set. Select this to set any desired value.
		Upper line	Adjust the measurement area of measurement area 2 to track the [Start] setting value for measurement area 1.
		Lower line	Adjust the measurement area of measurement area 2 to track the [End] setting value of measurement area 1.
		Upper line and lower line	Adjust the measurement area of measurement area 2 to track the [Start] and [End] setting value of measurement area 1.
	Base	Edge1/Edge2/Edge3/Edge4/peak (default value: Edge1)	Select the measurement surface of measurement area 1 to be used as the reference for automatic tracking. The peak is the surface of all measurement surfaces having the highest received light amount.
	Follow	Edge1/Edge2/Edge3/Edge4/peak (default value: Edge2)	Select the measurement surface of measurement area 1 to be used as the reference for automatic tracking. The measurement area 2 is automatically set referenced to the surface selected when [Area Teach] is clicked. The peak is the surface of all measurement surfaces having the highest received light amount.

- ▶ **Explorer pane** : [Bank] | [(Bank Data Name)] (double click)
- **Edit pane** : [Sensing setting] icon ()
- **Sensing settings window** : [Measurement area 2] - [Area follow setting]

1 Set [Area follow].

2 Set [Reference surface] and [Following surface].

3 Click [Area Teach].

The range applied to measure the measurement surface (Follow) is automatically set as the measurement area 2.

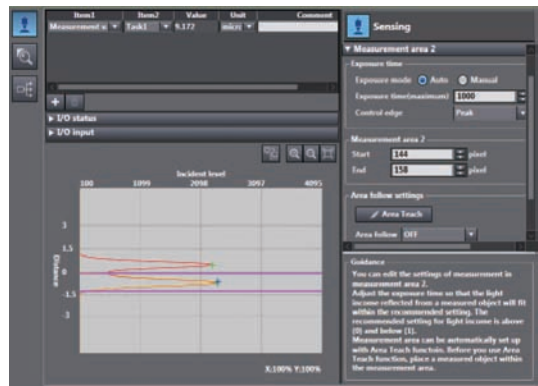

4-2 Setting Measurement Items

What is a Measurement Item?

Obtain the waveform data based on the specified sensing condition, and calculate the height/thickness of up to four surfaces included in the measuring range. Perform calculations using the output result of each task. Count the measurement surface closest to the Sensor Head first.

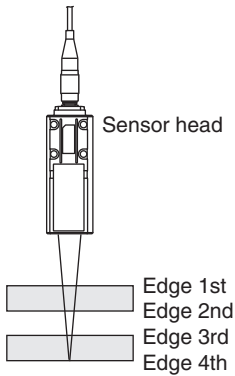

Measuring the Height

The setting for common height measurements as shown in the following diagram is registered for TASK1 in advance. In such a case, this setting is not required.

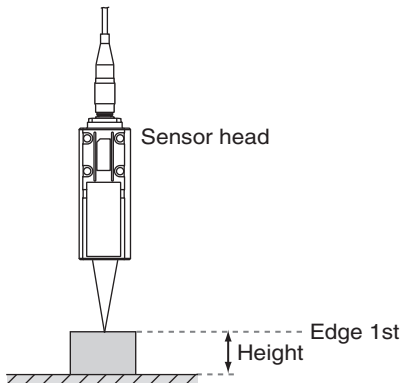

Set this item when measuring the height of an object below a transparent object as shown in the following diagram.

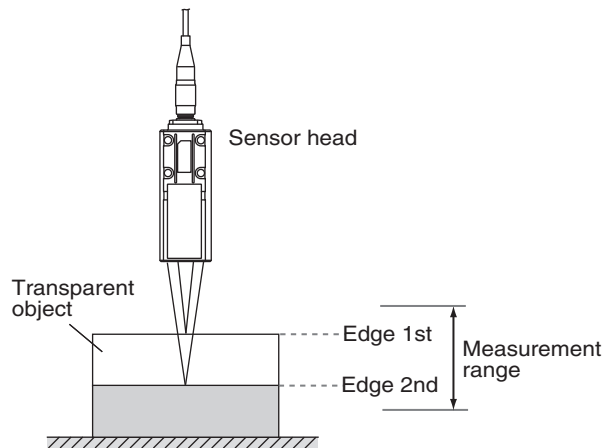

Item	Setting item	Setting value	Description
Height settings	Measurement area	Area 1 (default value)/Area 2	The area targeted for measurement can be switched.
	Measurement surface	Edge1/Edge2/Edge3/Edge4/peak (default value)	The measurement surface targeted for measurement can be switched. The peak is the surface of all measurement surfaces having the highest received light amount.

- ▶ **Explorer pane** : [Bank] | [(Bank Data Name)] (double click)
 - **Edit pane** : [Task Settings] icon (🔍)
 - **Task Settings window** : [Measurement mode] - [Height]

- 1** Select the measurement area targeted for measurement from [Measurement area].
- 2** Select the measurement surface targeted for measurement from [Measurement surface].

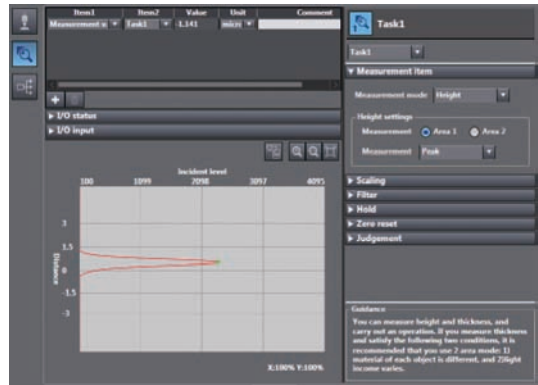

Important

[Height] and [Edge1] are preset to TASK1 as the measurement item and measurement surface, respectively. To measure the height in TASK2 to TASK4, set Edge1 first.

Note

Height measurement can also be set by the operating keys on the Sensor Controller.

 Measuring the Height p.231

Measuring the Thickness

If you have glass of known thickness, scaling can be adjusted referenced to that glass so that transparent objects can be measured more easily.

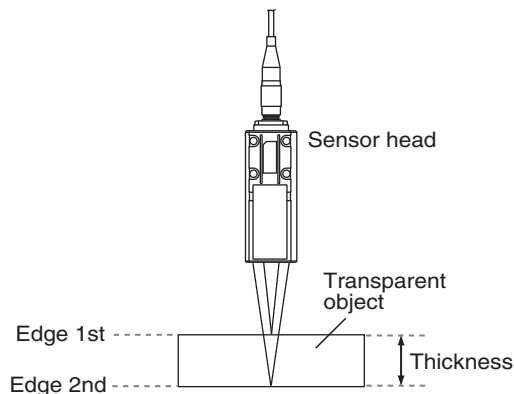

Item	Setting item	Setting value	Description
Thickness settings	Measurement area	Area 1 (default value)/Area 2	The area targeted for measurement can be switched.
	Measurement surface 1	Edge1/Edge2/Edge3/Edge4/ peak (default value)	The measurement surface (top surface) targeted for measurement can be switched. The peak is the surface of all measurement surfaces having the highest received light amount.
	Measurement surface 2	Edge1/Edge2/Edge3/Edge4/ peak (default value)	The measurement surface (rear surface) targeted for measurement can be switched. The peak is the surface of all measurement surfaces having the highest received light amount.

- ▶ **Explorer pane** : [Bank] | [(Bank Data Name)] (double click)
- **Edit pane** : [Task Settings] icon (🔍)
- **Task Settings window** : [Measurement mode] - [Thickness]

- 1** Select the measurement area targeted for measurement from [Measurement area].
- 2** Select the measurement surface (top surface) targeted for measurement from [Measurement surface 1].
- 3** Select the measurement surface (rear surface) targeted for measurement from [Measurement surface 2].

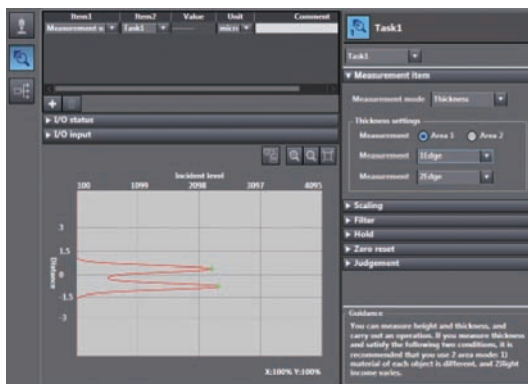

Note

- Thickness measurement can also be set by the operating keys on the Sensor Controller.

Measuring the Thickness p.232

- For the operation of the thickness scaling, refer to p.88.

Performing Calculations

Perform calculations using the results calculated by the tasks. The calculation formula is $mX+nY+K$.

Item	Setting item	Setting value	Description
Calculation	Parameter X	OFF (default value)/TASK1 to TASK4	The task to be calculated can be switched.
	Parameter Y	OFF (default value)/TASK1 to TASK4	The task to be calculated can be switched.
	Parameter K	-999.999999 to 999.999999 (default value: 0)	Set the offset value.
	Parameter m	-0.0 to 10.0 (Default value: 0)	Set the coefficient value.
	Parameter n	-0.0 to 10.0 (Default value: 0)	Set the coefficient value.

- **Explorer pane** : [Bank] | [(Bank Data Name)] (double click)
- **Edit pane** : [Task Settings] icon (🔍)
- **Task Settings window** : [Measurement mode] - [Calculation]

- 1** Select the task to be calculated from [Parameter X] and [Parameter Y].
- 2** Select the offset value from [Parameter K].
- 3** Select the coefficient from [Parameter m] and [Parameter n].

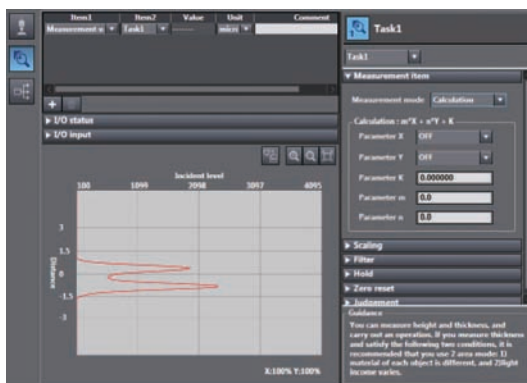

Note

Performing Calculations can also be set by the operating keys on the Sensor Controller.

 Calculating p.233

4-3 Setting the Output Conditions

Setting Scaling

This setting is used when you want to correct any errors that are generated due to the installation status of the Sensor Head, and display the corrected value on the main display as a measured value.

There are three types of setting: "auto scaling" ("1-point scaling" and "2-point scaling") that automatically sets the correction value of a placed sensing object, "fixed scaling" that manually sets the correction value and "thickness scaling" that automatically sets the correction value of a placed sensing object (transparent object).

Important

The "Zero reset" p.61 settings return to the default settings when scaling is set. If scaling is set, perform a zero reset as necessary.

Performing Manual Scaling

Set the scaling by entering the correction value.

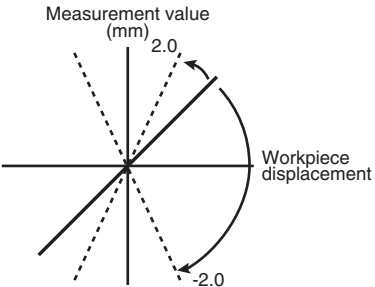
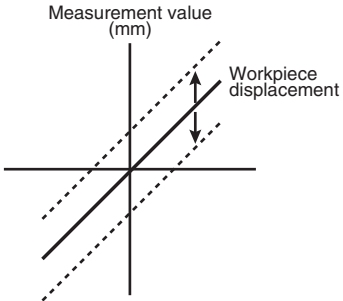
Item	Setting item	Setting value	Description
Scaling (Manual scaling)	Scaling	OFF (default value)/ON	Set scaling ON/OFF.
	Span	-2.0000 to 2.0000 (default value: 1.0000)	Set the inclination of the sensor characteristics as a coefficient. 
	Offset	-999.999999 to 999.999999 (default value: 0)	A fixed value is added to/subtracted from the measured value. 

- ▶ **Explorer pane** : [Bank] | [(Bank Data Name)] (double click)
- **Edit pane** : [Task Settings] icon (🔧)
- **Task Settings window** : [Scaling]

- 1 Select [Scaling].
- 2 Enter the correction value to [Span] and [Offset].

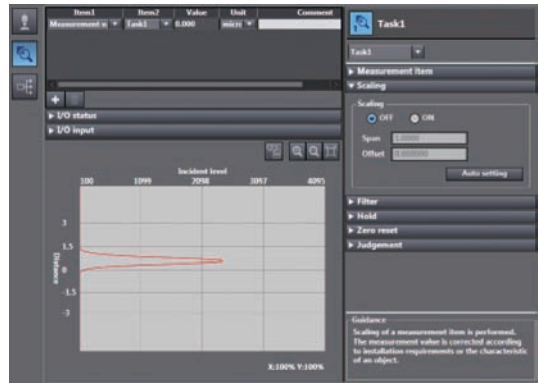

Note

Fixed scaling can also be executed by the operating keys on the Sensor Controller.

Performing Manual Scaling p.240

Automatically Setting Scaling

Performing 1-point Scaling

Measurement is performed at one position, and offset values are set for that measured value. The offset and increment/decrement inversion can be set.

Example: When displaying the distance to the sensing object

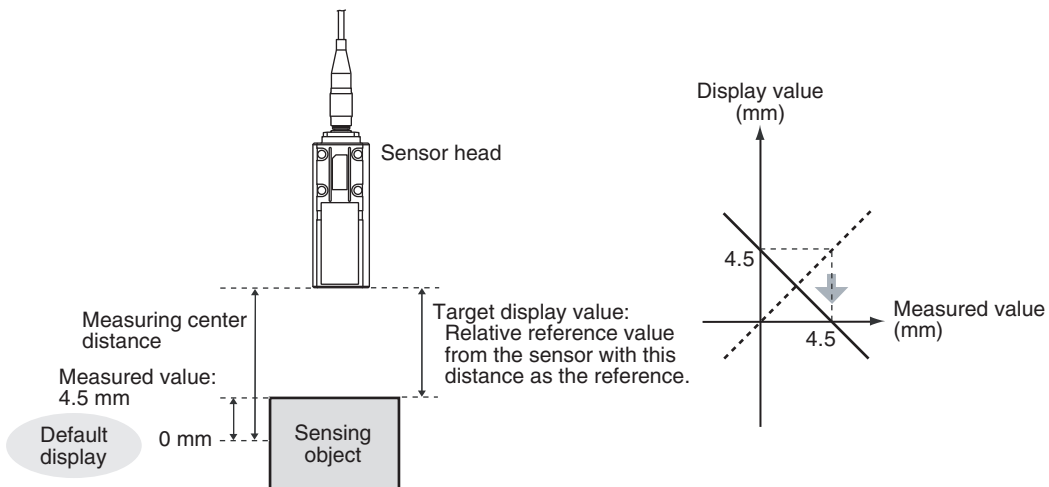

Item	Setting item	Setting value	Description
Actual scaling (one point)	Set value	-999.999999 to 999.999999 [mm]	Correct the measured value, and set the value to display.
	Scaling direction	Inverse change	The FAR side becomes a plus value.
		Forward change	The NEAR side becomes a plus value.

- ▶ **Explorer pane** : [Bank] | [(Bank Data Name)] (double click)
- **Edit pane** : [Task Settings] icon (🔧)
- **Task Settings window** : [Scaling]

- 1** Select [Scaling] ON.
- 2** Click [Auto setting].
The [Scaling] popup menu appears.
- 3** Select [Actual scaling (one point)], and click [Next >].
The [Scaling] popup menu display changes to [1st point settings], and the current measured value is displayed at [Current value].

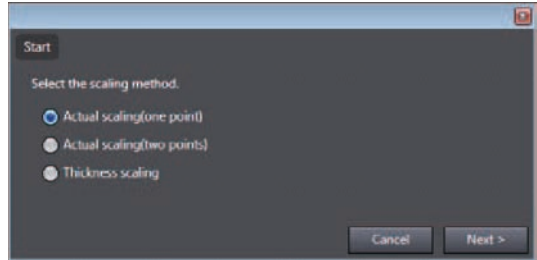

- 4** Click [STOP] to fix the [Current value], set [Set value] and click [Next >].
The [Scaling] popup menu display changes to [Direction settings].

Note

The [Current value] display is refreshed at a 100 ms cycle. When [STOP] is clicked, refreshing of the [Current value] display stops. Clicking the [STOP] button again resumes display refreshing.

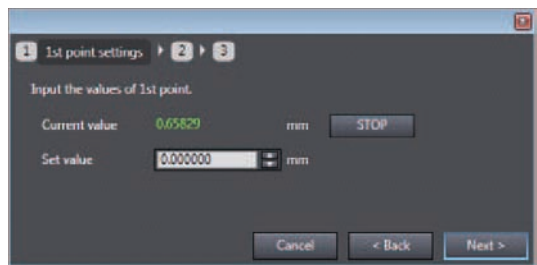

- 5** Set the change direction, and click [Next >].
The [Scaling] popup menu display changes to [Confirm the scaling parameters], and the span and offset values are displayed.

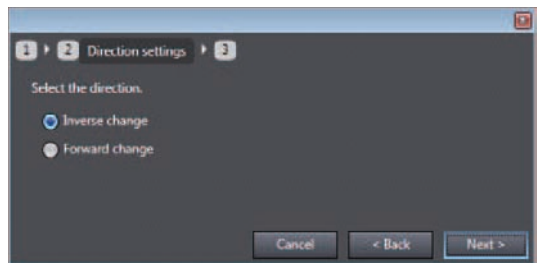

- 6** Click [OK].

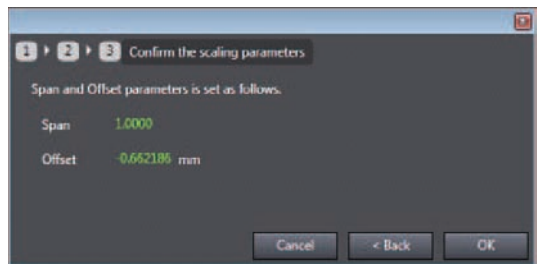

Note

1-point scaling can also be executed by the operating keys on the Sensor Controller.

Performing 1-point Scaling p.241

Performing 2-point Scaling

Measurement is performed at two positions, and offset values are set for those measured values.

Example: When correcting display values to match actual distances

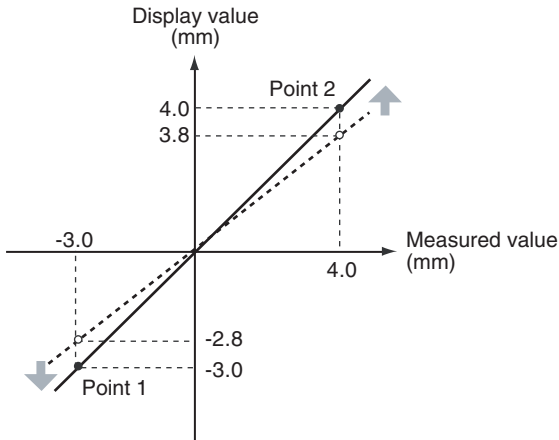

Item	Setting item	Setting value	Description
Actual scaling (two points)	Set value (1st point)	-999.999999 to 999.999999 [mm]	Correct the measured value of the 1st point, and set the value to display.
	Set value (2nd point)	-999.999999 to 999.999999 [mm]	Correct the measured value of the 2nd point, and set the value to display.

Important

Separate the two specified points by at least 1% of the rated measuring range for the connected Sensor Head.

For example, for the ZW-S40, the two measured points must be separated by at least $12 \text{ mm} \times 0.01 = 0.12 \text{ mm}$ as the measuring range is $12 \text{ mm} (\pm 6 \text{ mm})$.

- **Explorer pane** : [Bank] | [(Bank Data Name)] (double click)
- **Edit pane** : [Task Settings] icon (🔍)
- **Task Settings window** : [Scaling]

- 1 Select [Scaling] ON.
- 2 Click [Auto setting].
The [Scaling] popup menu appears.

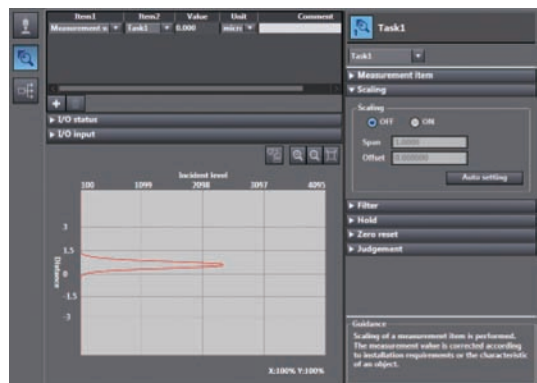

3 Select [Actual scaling (two points)], and click [Next >].

The [Scaling] popup menu display changes to [1st point settings].

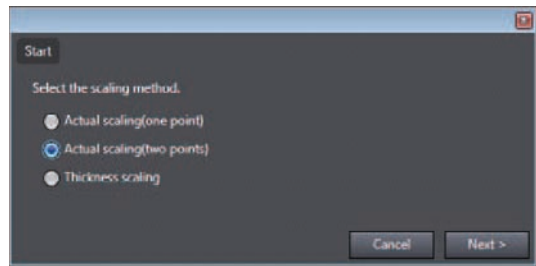

4 Set correction of the 1st point. Click [STOP] to fix the [Current value], set [Set value] and click [Next >].

The [Scaling] popup menu display changes to [2nd point settings].

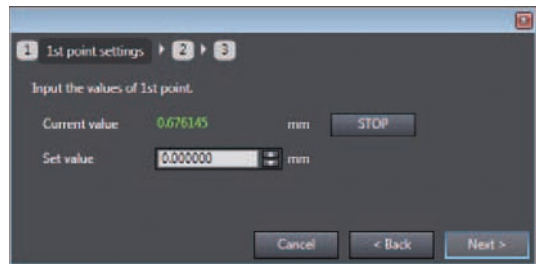

Note

The current measured value is displayed at [Current value], and is refreshed at 100 ms cycles. When [STOP] is clicked, refreshing of the [Current value] display stops. Clicking the [STOP] button again resumes display refreshing.

5 In the same way, set correction of the 2nd point.

The [Scaling] popup menu display changes to [Direction settings]. When the change direction is set and [Next>] is clicked, the [Scaling] popup menu display changes to [Confirm the scaling parameters], and the span and offset values are displayed.

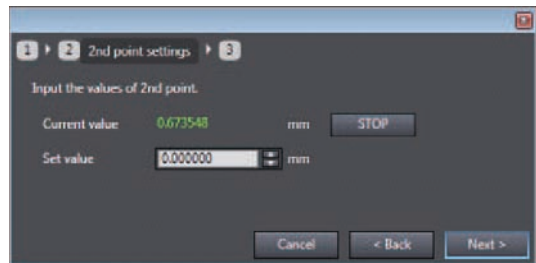

6 Click [OK].

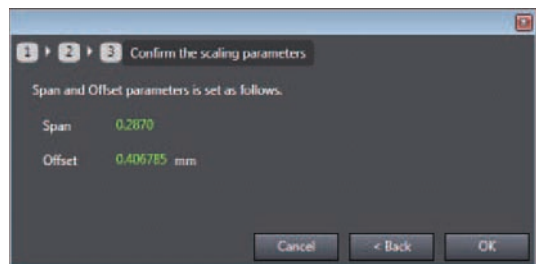

Note

2-point scaling can also be executed by the operating keys on the Sensor Controller.

 Performing 2-point Scaling p.242

Performing Thickness Scaling

The thickness is measured at one position and offset values are set for that measured value.

Item	Setting item	Setting value	Description
Thickness scaling	Setting value	-999.999999 to 999.999999 [mm]	Correct the measured value, and set the value to display.

- ▶ **Explorer pane** : [Bank] | [(Bank Data Name)] (double click)
- **Edit pane** : [Task Settings] icon 
- **Task Settings window** : [Scaling]

1 Select scaling ON/OFF from [Scaling].

2 Click [Auto setting].

The [Scaling] popup menu appears.

3 Select [Thickness scaling], and click [Next >].

The [Scaling] popup menu display changes to [Thickness settings].

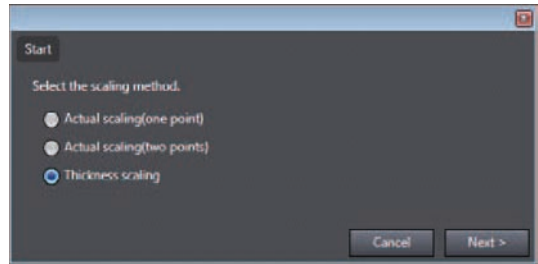

4 Click [STOP] to fix the [Current value], set [Set value] and click [Next >].

The [Scaling] popup menu display changes to [Confirm the scaling parameters], and the span and offset values are displayed.

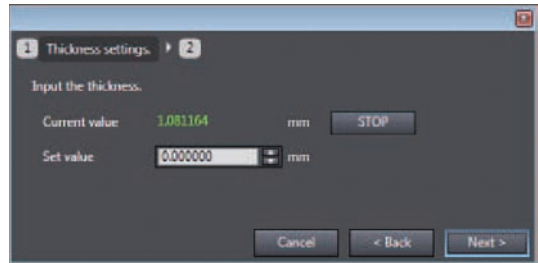

Note

The current measured value is displayed at [Current value], and is refreshed at 100 ms cycles. When [STOP] is clicked, refreshing of the [Current value] display stops. Clicking the [STOP] button again resumes display refreshing.

5 Click [OK].

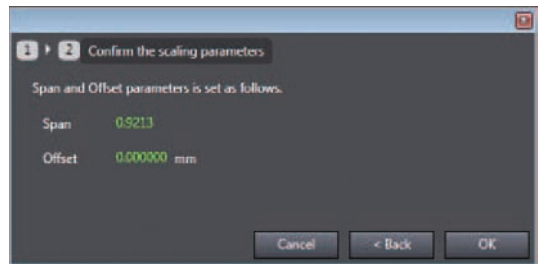

Note

Thickness scaling can also be executed by the operating keys on the Sensor Controller.

 Performing Thickness Scaling p.243

Setting Filters

Set the filter condition when filtering information obtained from the sensor before output. The following types of filters can be set depending on purpose.

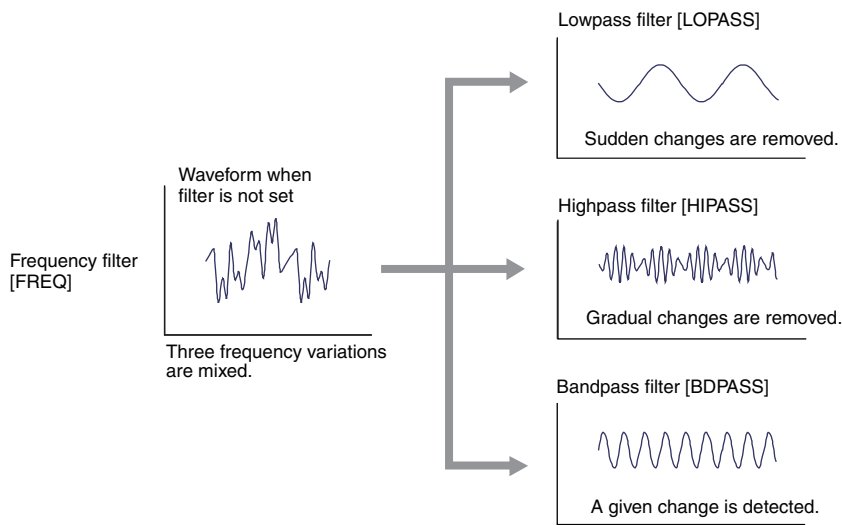
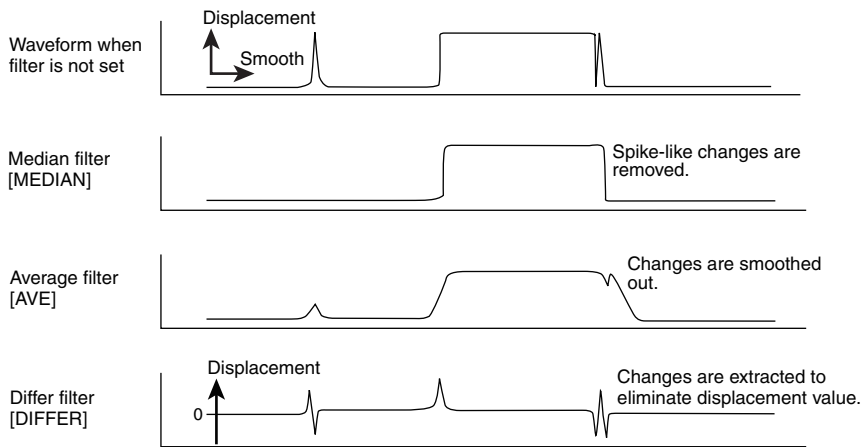

Setting the Median Filter

The intermediate value of multiple sets of data can be output as the measurement result.

Item	Setting item	Setting value	Description
Medial filter	Filter mode	OFF (default value)	Median filter is not used.
		LOW	Outputs the intermediate value of the last three measurements.
		Middle	Outputs the intermediate value of the latest nine measurements.
		HIGH	Outputs the intermediate value of the last 15 measurements.

- ▶ **Explorer pane** : [Bank] | [(Bank Data Name)] (double click)
- **Edit pane** : [Task Settings] icon 
- **Task Settings window** : [Filter]

- 1 Select how many of the latest intermediate values to output from [Medial filter] - [Filter mode].

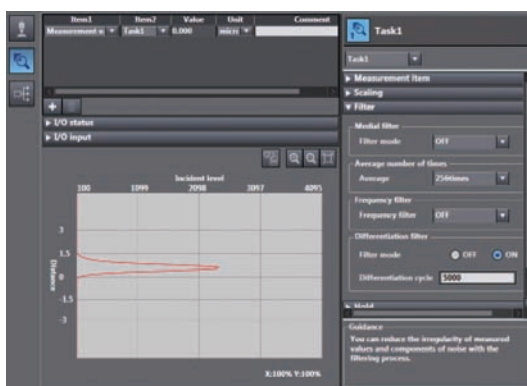

Note

The median filter can also be set by the operating keys on the Sensor Controller.

 Setting the Median Filter p.236

Setting the Average Filter

Output measured data as the average value of a preset count.
Set this, for example, to ignore sudden changes in measured value.

Item	Setting item	Setting value	Description
Average number of times	Average	1/2/4/8/16/32/64/128/256 (default value)/512/1024/2048/4096 [times]	Switches the average count.

- ▶ **Explorer pane** : [Bank] | [(Bank Data Name)] (double click)
- **Edit pane** : [Task Settings] icon (🔍)
- **Task Settings window** : [Filter]

- 1 Select how many times the latest measured values are to be averaged before output from [Average number of times] - [Average].

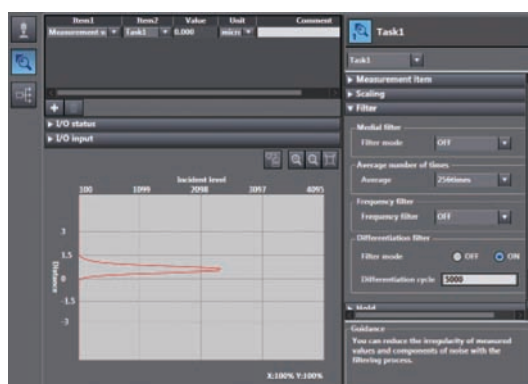

Important

When measurement is started, the measurement result is not updated and output until the measured values have been sampled for the preset average count.

Note

The average filter can also be set by the operating keys on the Sensor Controller.

 Setting the Average Filter p.237

Setting the Frequency Filter

Set a filter to ignore or detect the changes in a specific frequency in the measured data.

Item	Setting item	Setting value	Description
Frequency filter	Frequency filter	OFF (default value)	Frequency filter is not used.
		Lowpass filter	Ignores frequency components larger than the specified cut-off frequency. (Only gradual changes are captured.)
		Highpass filter	Detects frequency components smaller than the specified cut-off frequency. (Sudden changes are captured.)
		Bandpass filter	Detects the frequency components between the cut-off frequency (lower limit) and the cut-off frequency (upper limit).
	Cutoff frequency	0.001 (default value) to 999.999 [Hz]	Set this item when a low pass filter or a high pass filter is selected.
	Cutoff frequency (Upper limit)	0.001 (default value) to 999.999 [Hz]	Set this item when a band pass filter is selected.
	Cutoff frequency (Lower limit)		

- **Explorer pane** : [Bank] | [(Bank Data Name)] (double click)
 → **Edit pane** : [Task Settings] icon (🔧)
 → **Task Settings window** : [Filter]

- 1 Select the frequency filter type from [Frequency filter].
- 2 Set the cutoff frequency from [Cutoff frequency]. When a band pass filter is selected, set [Cutoff frequency (upper limit)] and [Cutoff frequency (lower limit)].

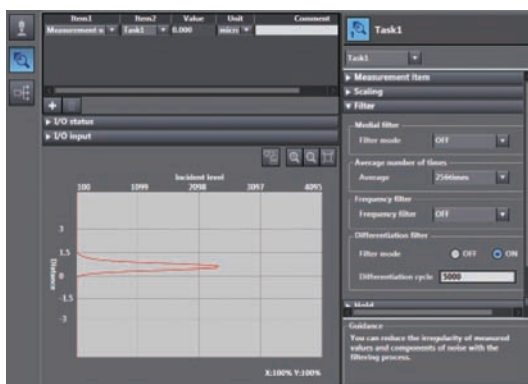

Note

The frequency filter can also be set by the operating keys on the Sensor Controller.

Setting the Frequency Filter p.238

Important

- Set the cut-off frequency to a value smaller than one-half of the sampling frequency. Otherwise, the frequency filter will not function properly. If a value outside of the appropriate range is set, the frequency filter will be applied with the values included in the range.
- If the cut-off frequency values (upper/lower limits) are too close, the frequency bandwidth to be detected cannot be properly detected.
- The sampling frequency is the inverse of the measuring cycle.
- The measuring cycle can be viewed in the "System Information" menu on the Sensor Controller.

Checking Information p.260

Setting the Differentiation Filter

Set this filter to detect sudden changes in measured values occurring within an extremely short time. The differentiation filter detects changes in the measured value and current value before a comparison interval. The time of this comparison interval is defined as the differential cycle. (Default value: OFF)

Item	Setting item	Setting value	Description
Differentiation filter	Filter mode	OFF (default value)/ON	Set the differentiation filter ON/OFF.
	Differentiation cycle	1 (default value) to 5000 [ms]	Set the internal time for the measurement value to be compared with the current value.

- **Explorer pane** : [Bank] | [(Bank Data Name)] (double click)
- **Edit pane** : [Task Settings] icon 
- **Task Settings window** : [Filter]

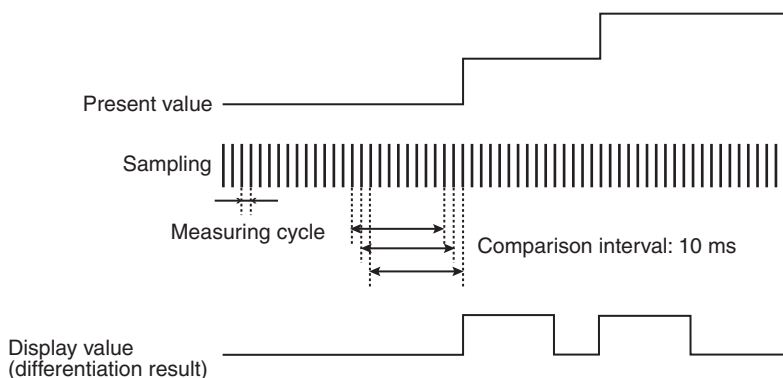

- 1** Select differentiation filter ON/OFF from [Differentiation filter] - [Filter mode].
- 2** Set the number of differential cycles from [Differentiation cycle].

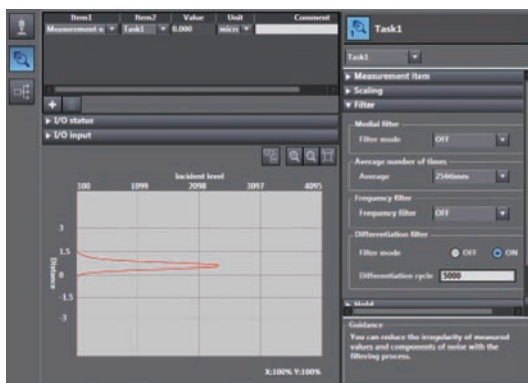

Note

The differentiation filter can also be set by the operating keys on the Sensor Controller.

 Setting the Differentiation Filter p.239

Setting Hold

Set the hold conditions of the measured value.

The hold function holds (retain) any value from the measured values during the specific time (sampling period), such as the maximum or minimum value.

Setting the Hold Mode

Set the hold mode of the measured value.

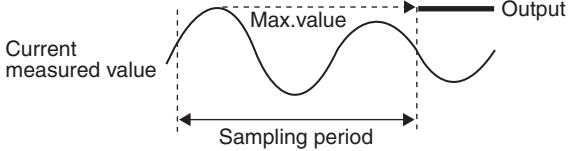
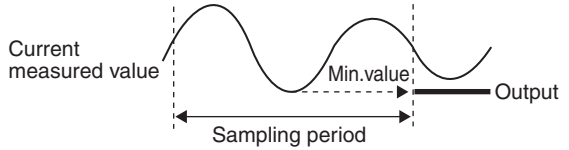
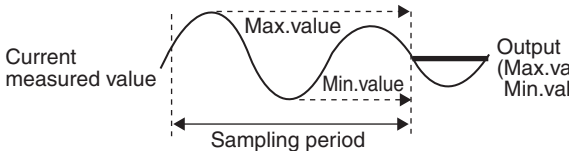
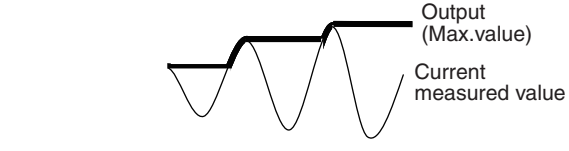
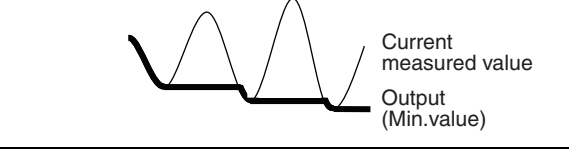
Item	Setting item	Setting value	Description
Hold	Hold mode	Peak	<p>Holds the "maximum value" of the sampling period. Output changes after sampling, and this state is held until the next sampling ends.</p> 
		Bottom	<p>Holds the "minimum value" of the sampling period. Output changes after sampling, and this state is held until the next sampling ends.</p> 
		Peak to Peak	<p>Holds the "difference between the maximum value and the minimum value" of the sampling period. Mainly select this when detecting vibration, for example. Output changes after sampling, and this state is held until the next sampling ends.</p> 
		Auto Peak	<p>Holds the "maximum value" of the measurement result. The output changes every time the maximum value is updated.</p> 
		Auto Bottom	<p>Holds the "minimum value" of the measurement result. The output changes every time the minimum value is updated.</p> 

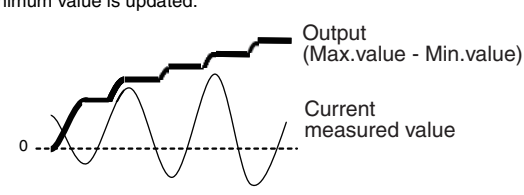
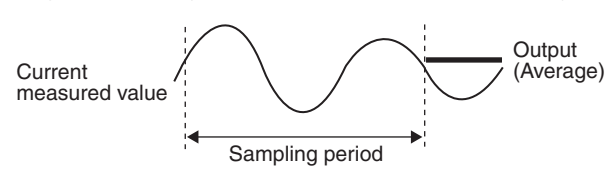
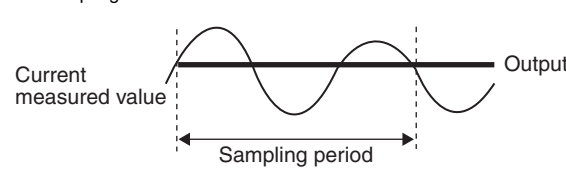
Item	Setting item	Setting value	Description
Hold	Hold mode	Auto Peak to Peak	Holds the difference between the maximum and minimum values of the measurement result. The output changes every time the maximum or the minimum value is updated. 
		Average	Holds the "average of the measured value" of the sampling period. Output changes after sampling, and this state is held until the next sampling ends. 
		Sampling	Holds the measured value the moment that control enters the sampling period. Output changes at the start of sampling, and this state is held until the next sampling is started. 
		Through (default value)	The hold function is not used. The measured value is always output.

- ▶ **Explorer pane** : [Bank] | [(Bank Data Name)] (double click)
- **Edit pane** : [Task Settings] icon (🔧)
- **Task Settings window** : [Hold]

1 Select the hold mode from [Hold mode].
 Setting items for required parameters are displayed depending on the selected hold mode.

 Setting Triggers p.97

 Setting a Trigger Delay p.100

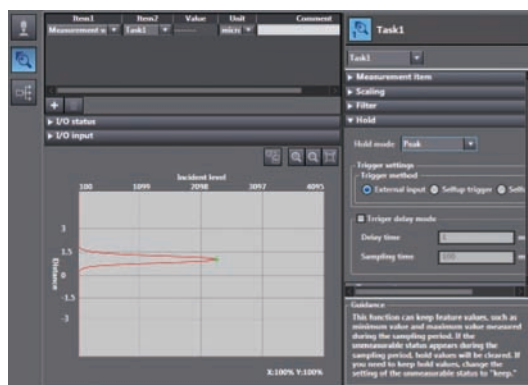

Note

The hold mode can also be set by the operating keys on the Sensor Controller.

 Setting the Hold Mode p.244

Hold clearing conditions

Held values can be cleared by the following operation.

- When FUN (adjustment) mode/RUN (operation) mode is switched
- When hold RESET is entered (20-pole terminal block,  key)
- Hold RESET command is entered.

(Example) Peak

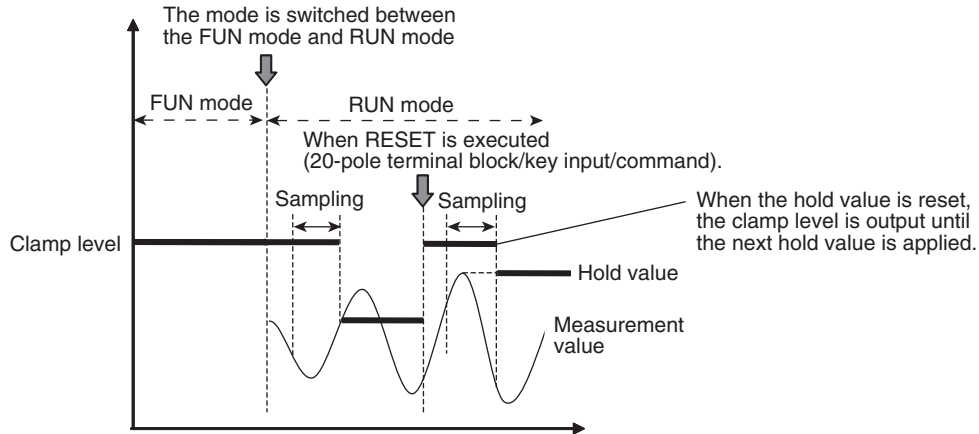

(Example) Auto Peak

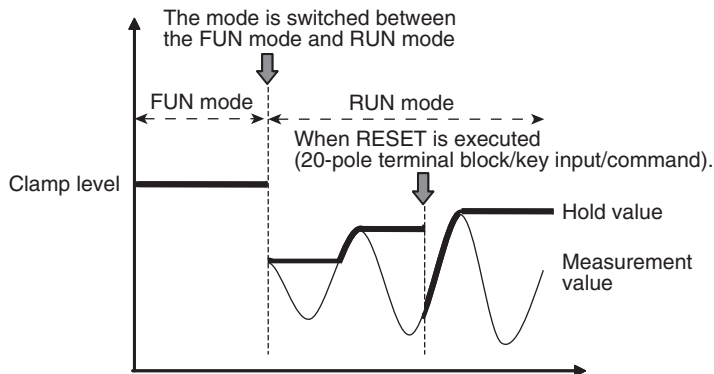

Important

If an abnormal measured value is obtained during sampling, the hold value is cleared. To not clear the hold value even if an abnormal measured value is obtained, set "KEEP" as the non-measurement setting.

 Setting operation when measurement is not possible p.150

Setting Triggers

Set how measurement start to end timing is to be input.

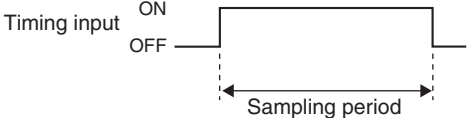
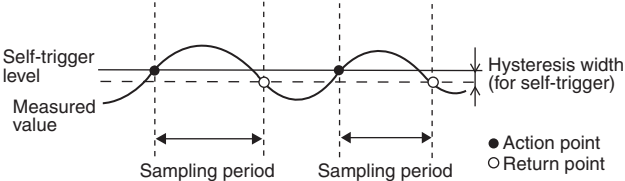
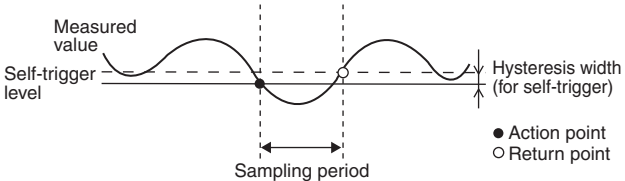
Item	Setting item	Setting value	Description
Trigger Settings	Trigger method	External input	<p>Enter the trigger for the start of sampling in "TIMING input" for the 20-pole terminal block. The period that the signal input to "TIMING input" is ON is the sampling period.</p>  <p>Important</p> <p>When a delay time is set, input OFF and sampling period end are not synchronized. End timing is after the specified sampling period has elapsed.</p>
		Selfup trigger	<p>The period in which the measured value exceeds the preset self-trigger level is taken to be the sampling period. Hold measurement can be performed without a synchronous input.</p>  <p>Important</p> <p>When a delay time is set, the timing that the measured value falls below the self-trigger level and the sampling period end are not synchronized. End timing is after the sampling period has elapsed.</p>
		Selfdown trigger	<p>The period in which the measured value falls below the preset self-trigger level is taken to be the sampling period. Hold measurement can be performed without a synchronous input.</p>  <p>Important</p> <p>When a delay time is set, the timing that the measured value exceeds the self-trigger level and the sampling period end are not synchronized. End timing is after the sampling period has elapsed.</p>
	Trigger level	-999.999999 to 999.999999 [mm] (default value: 0)	Set the self-trigger level when [SELF-UP] or [SELF-DOWN] are selected at [Trigger method].
	Trigger hysteresis	0 to 999.999999 [mm] (default value: 0.05% of measuring range)	Set the hysteresis width for the self-trigger when [SELF-UP] or [SELF-DOWN] are selected at [Trigger method].

- Explorer pane : [Bank] | [(Bank Data Name)] (double click)
- Edit pane : [Task Settings] icon (🔧)
- Task Settings window : [Hold]

1 Set the hold mode.

📖 Setting the Hold Mode p.94

2 Select the trigger method from [Trigger settings] - [Trigger method].

3 Enter [Trigger level] and [Trigger hysteresis] when [Selfup trigger] or [Selfdown trigger] are selected at [Trigger method].

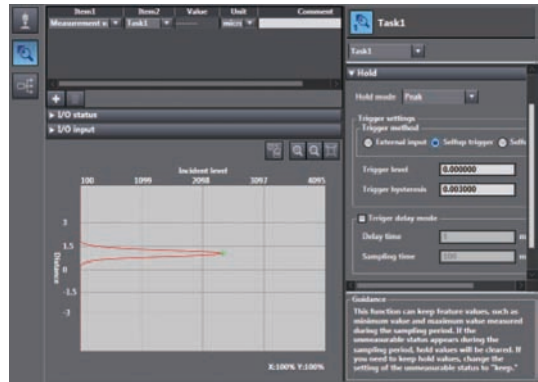

Important

Set "Trigger hysteresis" according to the fluctuation of the measured value near the trigger level. Hysteresis is applied simultaneously with start of measurement to prevent chattering of the TIMING input.

Note

The trigger can also be set by the operating keys on the Sensor Controller.

📖 Setting Triggers p.245

Performing Hold with a Key Input

The TIMING/RESET inputs can be held on the Sensor Controller by setting as follows.

Item	Setting item	Setting value	Description
Sensor settings	Timing/Reset key input	OFF (default value)/ON	Enables TIMING and RESET key inputs from the Sensor Controller.

 Setting the Hold Mode p.94

- **Explorer pane** : [System] (double-click)
→ **Edit pane** : [Sensor Settings] icon 

1 Set the operating mode to the FUN mode.

 3-3 Switching operation modes p.57

2 Select ON/OFF from [Key input mode(Timing and Reset)].

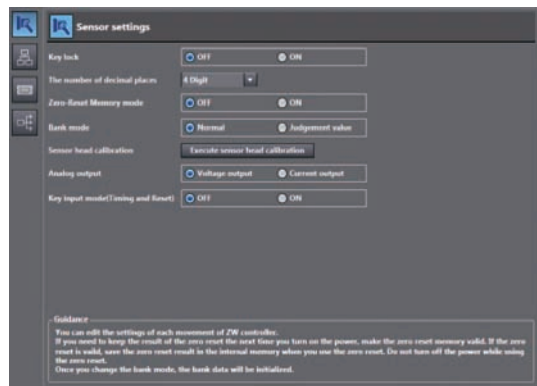

Note

The timing/reset key input can also be set by the operating keys on the Sensor Controller.

 Performing Hold with a Key Input p.246

Setting a Trigger Delay

Set this to ignore measure values following TIMING input to avoid the influence of bounding or mechanical vibration when a device is started up.

The delay time (the delay between timing input and the start of sampling) and the sampling time can be set.

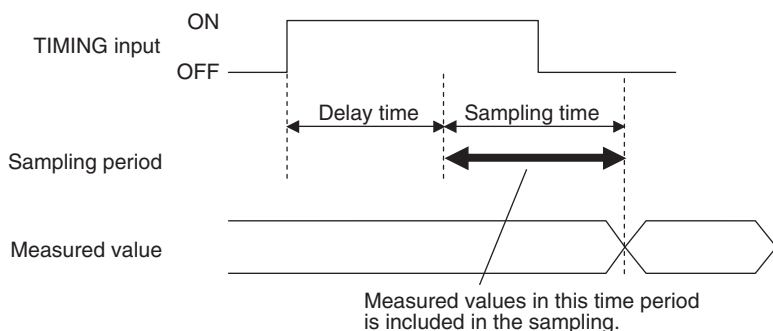

Item	Setting item	Setting value	Description
Trigger delay	Trigger delay mode	OFF (default value)/ON	Turns the trigger delay ON/OFF.
	Delay time	1 (default value) to 5,000 [ms]	Set the time from TIMING input ON up to start of sampling.
	Sampling time	1 to 5,000 [ms] (default value: 100ms)	Set to period during which sampling is to be performed.

► **Explorer pane** : [Bank] | [(Bank Data Name)] (double click)

→ **Edit pane** : [Task Settings] icon (🔍)

→ **Task Settings window** : [Hold]

1 Set the hold mode and trigger.

📖 Setting the Hold Mode p.94

📖 Setting Triggers p.97

2 Select ON/OFF from [Trigger delay] - [Trigger delay mode].

3 Enter [Delay time] and [Sampling time].

Important

Set so that the "delay time + sampling time" is shorter than the TIMING input interval. When the TIMING input turns ON again before the "delay time + sampling time" elapses, the TIMING input that is input later is ignored and is not reflected in sampling.

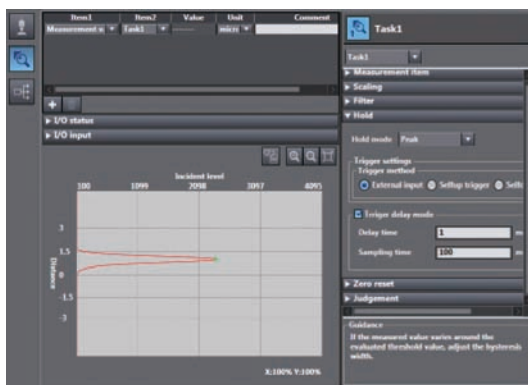

Note

The trigger delay can also be set by the operating keys on the Sensor Controller.

📖 Setting a Trigger Delay p.247

Setting the Zero Reset

Setting the Status

Set enable/disable of the zero reset function.

Important

The status is set for each task.

- ▶ **Explorer pane** : [Bank] | [(Bank Data Name)] (double click)
 - **Edit pane** : [Task Settings] icon (🔍)
 - **Task Settings window** : [Zero reset]

1 Select ON/OFF from [Status].

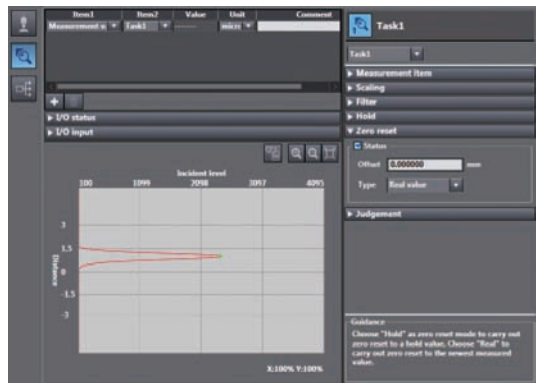

Note

The status can also be set by the operating keys on the Sensor Controller.

 Setting the Status p.248

Setting the Offset

Set this item to set the reference value by a zero reset to a value other than zero.

Item	Setting item	Setting value	Description
Zero reset	Offset	-999.999999 to 999.999999 [mm] (default value: 0)	Set the offset value.

- ▶ **Explorer pane** : [Bank] | [(Bank Data Name)] (double click)
 - **Edit pane** : [Task Settings] icon (🔍)
 - **Task Settings window** : [Zero reset]

1 Set [Status] to ON.

 Setting the Status p.101

Important

Offset can be set only when [Status] is set to ON.

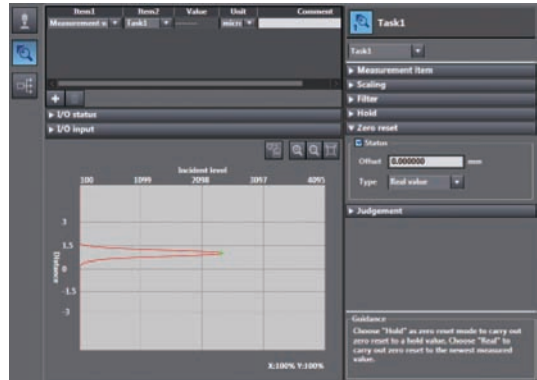

2 Enter an offset value at [Zero reset] - [Offset].

Note

The offset can also be set by the operating keys on the Sensor Controller.

 Setting the Offset p.249

Setting the Zero Reset Type

Set the zero reset type.

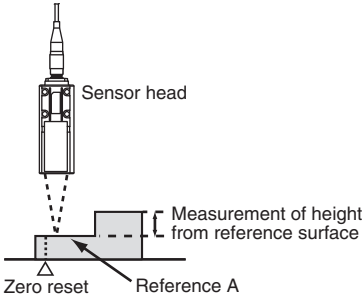
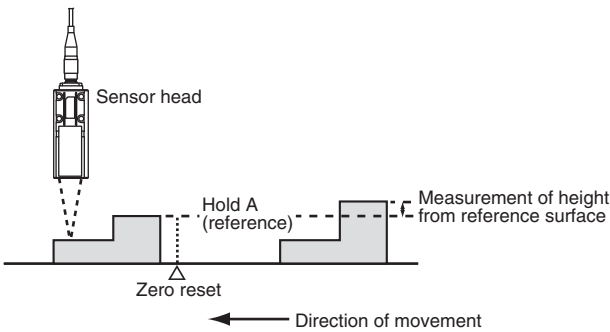
Item	Setting item	Setting value	Description
Zero reset	Zero reset type	Real value	<p>Sets the measured value when a zero reset is executed to zero.</p> 
		Hold value	<p>Sets the measured value (hold value) when a zero reset is executed to zero. This is enabled when hold measurement is performed.</p> 

- ▶ **Explorer pane** : [Bank] | [(Bank Data Name)] (double click)
- **Edit pane** : [Task Settings] icon (🔍)
- **Task Settings window** : [Zero reset]

1 Set [Status] to ON.

 Setting the Status p.101

Important

The zero reset type can be set only when [Status] is set to ON.

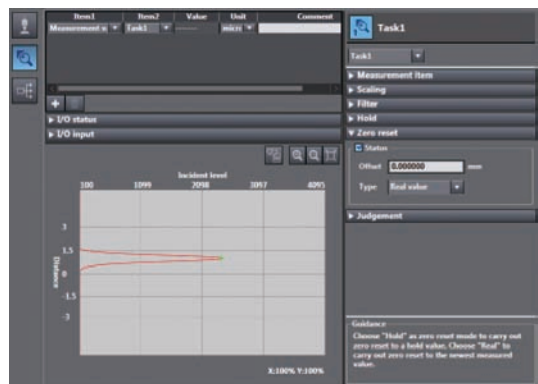

2 Select the zero reset type from [Type].

Note

The zero reset type can also be set by the operating keys on the Sensor Controller.

 Setting the Zero Reset Mode p.250

Setting the Zero Reset Memory

Select whether or not to hold the measured value zero reset level even if the power is turned OFF.

As shown in the figure below, use the zero reset memory still set to "OFF" when using this function to perform a zero reset at each measurement.

Example: When the level difference of a measurement target is measured

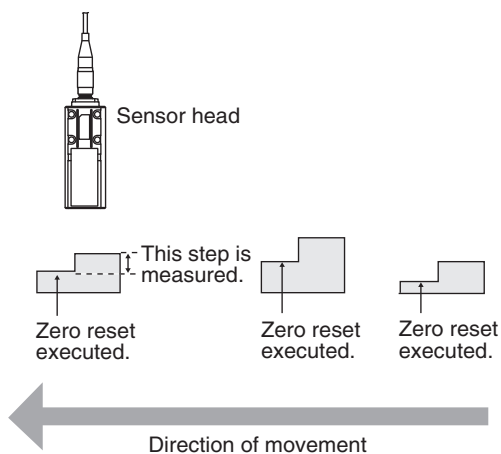



Item	Setting item	Setting value	Description
Sensor settings	Zero reset memory	OFF (default value)	The zero reset is canceled when the power is turned OFF.
		ON	The zero reset level is held even if the power is turned OFF.

Important

- When zero reset memory is set to "ON", the zero reset is written to EEPROM (non-volatile memory) in the Sensor Controller each time that a zero reset is performed. The EEPROM can be written a maximum of 1,000,000 times. Pay attention to the maximum number of writing allowed when this is set to "ON."
- Even if zero reset memory is disabled, the zero reset level will be held also when the setting is saved. In this instance, the zero reset will also be continued after a restart.

1 Set the operating mode to the FUN mode.

 3-3 Switching operation modes p.57

- ▶ **Explorer pane** : [System] (double-click)
- **Edit pane** : [Sensor Settings] icon 

2 Select ON/OFF from [Zero-Reset Memory mode].



Note

The zero reset mode can also be set by the operating keys on the Sensor Controller.

 Setting the Zero Reset Memory p.251

4-4 Setting the Banks

Changing the Bank Mode

Select the bank contents to be obtained from the settings or judgment value.

Item	Setting item	Setting value	Description
Sensor settings	Bank mode	Normal (default value)	Sensing setting, measurement setting and I/O setting that are set in the FUN (adjustment) mode are regarded as bank data. The number of banks is up to eight.
		Judgement value	Only the threshold value under the measurement setting is regarded as bank data. The number of banks increases up to 32.

1 Set the operating mode to the FUN mode.

 3-3 Switching operation modes p.57

- **Explorer pane** : [System] (double-click)
- **Edit pane** : [Sensor Settings] icon 

2 Select the bank mode from [Bank mode].



Note

The bank mode can also be set by the operating keys on the Sensor Controller.

 Changing the Bank Mode p.253

Copying the Bank/System Settings

Copy the selected bank setting to another bank.
Also, copy ZW system settings to a different ZW.

1 Set the operating mode to the FUN mode.

 3-3 Switching operation modes p.57

2 Copy the bank data or system data.

Select the copy source bank data or system data from the explorer pane, and select [Copy] from the right-click menu.

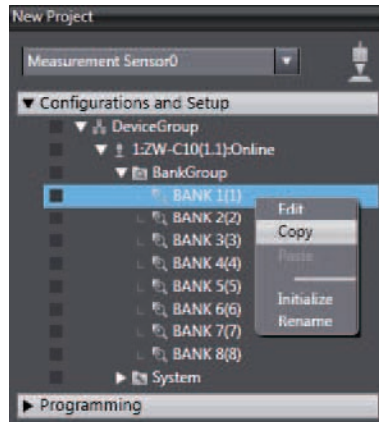

3 Paste the bank data or system data

Select the copy destination bank data or system data from the explorer pane, and select [Paste] from the right-click menu.

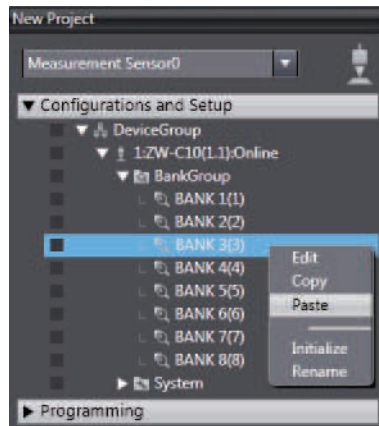

Note

The bank settings can also be copied by the operating keys on the Sensor Controller.

 Copying the Bank Settings p.254

Saving the Bank/System Settings

Save the bank/system settings to the Sensor Controller.

Important

- The settings of all banks are saved regardless of the currently selected bank number.
- After you have made or changed settings, be sure to save the setup data. All settings will be deleted if you turn the power OFF without saving the data.

1 Set the operating mode to the FUN mode.

 3-3 Switching operation modes p.57

- ▶ **Explorer pane** : [(ZW model name)] (double click)
 - **Edit pane** : [Online] icon ()
 - **Online setting window** : [Save data]

2 Select [Save data (Sensor internal memory)].

Bank/system settings are saved to Sensor internal memory.

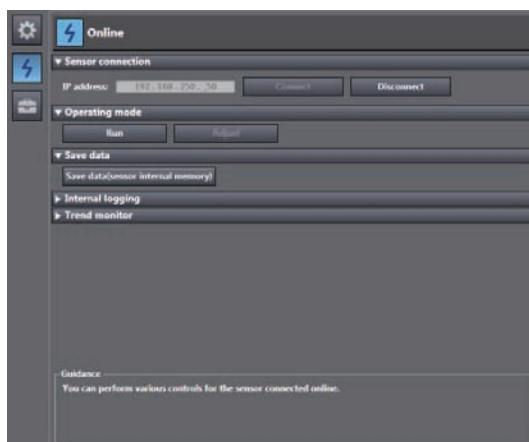

Note

- Settings can also be saved by selecting and right-clicking a [(ZW model)] from the explorer pane and selecting "Save settings" from the right-click menu.
- The bank/system settings can also be saved by the operating keys on the Sensor Controller.

 Saving the Bank/System Settings p.255

Clearing the Bank Settings

Select a bank and initialize its settings.

1 Set the operating mode to the FUN mode.

 3-3 Switching operation modes p.57

2 Select the bank data.

Select the bank data from the explorer pane, and select [Initialize] from the right-click menu.

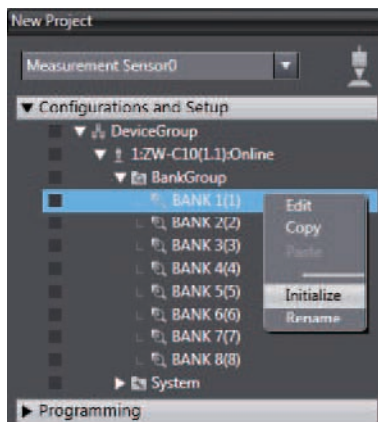

Note

The bank settings can also be cleared by the operating keys on the Sensor Controller.

 Initializing Settings p.263

4-5 Setting the System

Display/set the system environment.

Checking Information

Displays the information of the Sensor Controller and Sensor Head.

Item	Displayed item	Setting value	Description
General settings	Sensor information	Name	Displays the name of the Sensor Controller
		Sensor controller model	Displays the model information of the Sensor Controller.
		Software Version	Displays the version information of the software of the Sensor Controller.
		Sensor head model	Displays the model information of the Sensor Head.
		Sensor serial No.	Displays the serial No. of the Sensor Head.
		MAC address	Displays the MAC address that is set.

► **Explorer pane** : **[(ZW model name)] (double click)**

→ **Edit pane** : **[General Settings] icon (⚙️)**

1 The Edit pane main pane is displayed in the Edit pane.

You can check the above information under [General settings] - [Sensor information].

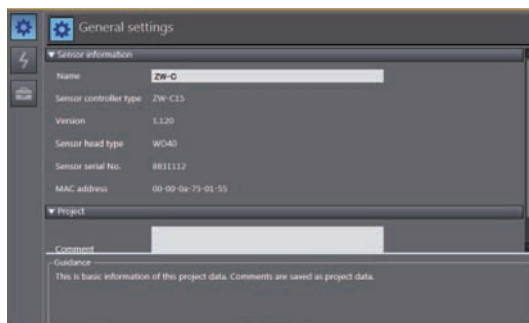

Note

In addition to the above information, the currently set measuring cycle can be checked by the operating keys on the Sensor Controller.

 Checking Information p.260

Making Sensor Settings

Setting the Key Lock

This function disables all key inputs on the Sensor Controller.

Once the key lock is set, no key input will be accepted until the lock is released. This function is useful for preventing inadvertent changes to settings.

Item	Displayed item	Setting value	Description
Sensor settings	Key lock	OFF (default value)	Cancels the key lock function.
		ON	Turns the key lock function ON.

Important

Note that, moving to the key lock setting menu or moving between menu hierarchies are possible even when the key lock function is ON by the operating keys on the Sensor Controller.

1 Set the operating mode to the FUN mode.

 3-3 Switching operation modes p.57

► **Explorer pane** : [System] (double-click)
→ **Edit pane** : [Sensor Settings] icon 

2 Select ON/OFF from [Key lock].

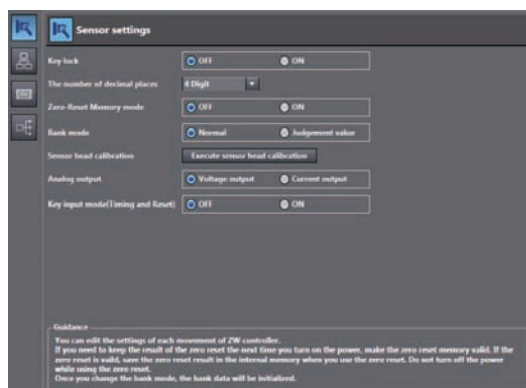

Note

The key lock can also be set by the operating keys on the Sensor Controller.

 Setting the Key Lock p.261

Setting the Number of Digits Displayed Past the Decimal Point

Set the number of digits displayed past the decimal point for when numerical values are displayed on the main display and sub-display of the Sensor Controller.

Item	Setting item	Setting value	Description
Sensor settings	The number of decimal places	0 to 5 Digit (default value: 4 digits)	Set the number of digits displayed past the decimal point for when numerical values are displayed on the Sensor Controller.

1 Set the operating mode to the FUN mode.

 3-3 Switching operation modes p.57

- ▶ **Explorer pane** : [System] (double-click)
- **Edit pane** : [Sensor Settings] icon 

2 Select the number of digits displayed past the decimal point from [The number of decimal places].

You can select from the above setting values.

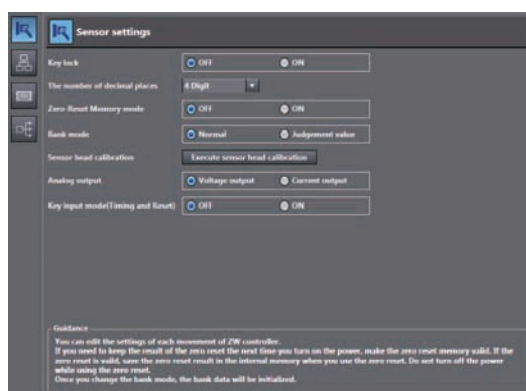

Initializing Settings

Returns all banks/system settings to their default settings.

Important

- The settings of all banks/system settings are returned to the default settings regardless of the currently selected bank number.
- Parameters for which the default values are decided by the Sensor Head measuring range (HYSTERESIS, TRIGGER HYSTERESIS, HIGH THRESHOLD, LOW THRESHOLD) are all set to the factory default value "0".

- ▶ **Explorer pane** : [(ZW model name)] (double click)
- **Edit pane** : [Tool] icon 

1 Click [Sensor setup] - [Initialize sensor].

Initialization is executed.

Note

-
- Settings can also be initialized by selecting and right-clicking a [(ZW model)] option from the explorer pane and selecting "Initialize sensor" from the right-click menu.
 - Settings can also be initialized by the operating keys on the Sensor Controller.



Initializing Settings p.263

MEMO

Convenient Functions

5-1 Displaying measured values in graphs	116
5-2 Saving measured values in a file	121
5-3 Displaying saved measured values	124
5-4 Performing internal logging	125
5-5 Storing the light reception wave form in a file	127
5-6 Recovering calibration ROM data.....	129
5-7 Printing the contents of settings	130
5-8 Controll input signal with PC tool.....	131

5-1 Displaying measured values in graphs

The measured values can be displayed in graphs.

- ▶ **Explorer pane** : [(ZW model name)] (double click)
 - **Edit pane** : [Online] icon (⚡)
 - **Online setting window** : [Trend Monitor]

- 1 Click [Trend Monitor] - [Start monitor].
The Trend Monitor window starts up.

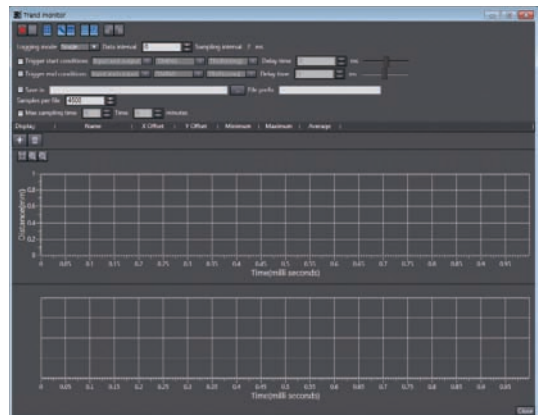
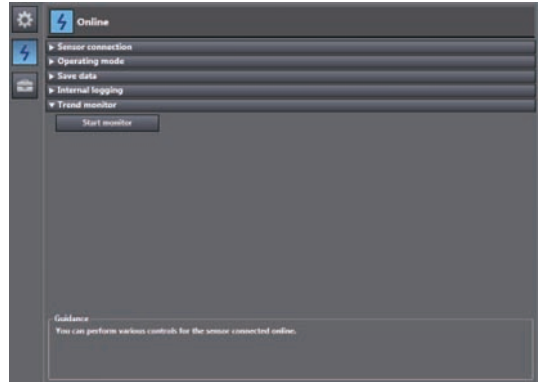

- 2 **Add the data to monitor the trend for.**
Add the data to monitor the trend for to the list.

Click the add target data icon (⊕).

Click the logging target data display icon (📄) to add to the list of data to be logged.

A new target data line is added.

Note

To delete target data from the list, select the line with the data to be deleted, then click the [Delete] or press the [Delete] key.

3 Select data to monitor the trend for.

Set data to monitor the trend for.

The types of data that can be set are as follows.

Item	Setting item	Description
Target data	TASK1	TASK1 measurement results
	TASK2	TASK2 measurement results
	TASK3	TASK3 measurement results
	TASK4	TASK4 measurement results
	TIMING	TIMING input signal (parallel I/O)
	ZERO	ZERO input signal (parallel I/O)
	BUSY	BUSY output signal (parallel I/O)
	ENABLE	ENABLE output signal (parallel I/O)
	HIGH	HIGH output signal (parallel I/O)
	PASS	PASS output signal (parallel I/O)
	LOW	LOW output signal (parallel I/O)

4 Set the logging sampling interval.

Set the logging sampling interval for the target data.

Item	Setting item	Range	Description
Sampling setting	Data interval	0 to 65535	Set the sampling interval for the target data.

5 Click the Start icon () to start the sampling.

When the sampling starts, the sampled data is displayed in the graph.

Note

You can also specify the timing (start trigger, end trigger) for the graph display.

6 Click the End icon () to end the sampling.

When the sampling ends, the graph display stops too.

Specifying the sampling start and end conditions

You can specify the conditions for starting and ending sampling.

1 Check the Trigger start conditions/Trigger end conditions checkbox.



2 Select the trigger condition.

Item	Setting item	Range	Description
Sampling setting	Trigger start conditions	Input and output	Specify parallel I/O (TIMING, ZERO, BUSY, ENABLE, HIGH, PASS, LOW) as the trigger condition.
		Data slope	Sets the change in the measured values for TASK1-4 as the start condition. Sets the trigger level. When the measured value rises above this value or falls below it, the start trigger is issued.
		Data window (In)	Sets the change in the measured values for TASK1-4 as the start condition. When the measured value is inside the range, the start trigger is issued.
		Data window (Out)	Sets the change in the measured values for TASK1-4 as the start condition. When the measured value is outside the range, the start trigger is issued.
	Trigger end conditions	Input and output	Specify parallel I/O (TIMING, ZERO, BUSY, ENABLE, HIGH, PASS, LOW) as the trigger condition.
		Data slope	Sets the change in the measured values for TASK1-4 as the start condition. Sets the trigger level. When the measured value rises above this value or falls below it, the end trigger is issued.
		Data window (In)	Sets the change in the measured values for TASK1-4 as the start condition. When the measured value is in the range, the end trigger is issued.
		Data window (Out)	Sets the change in the measured values for TASK1-4 as the start condition. When the measured value is outside the range, the end trigger is issued.
		Number of data	The sampling data is counted from when the start condition is met and when the specified number of data points have been sampled, the end trigger is issued.

3 Select the trigger target.

Item	Setting item	Range	Description
Trigger target	I/O	TIMING	TIMING input signal (parallel I/O)
		ZERO	ZERO input signal (parallel I/O)
		BUSY	BUSY output signal (parallel I/O)
		ENABLE	ENABLE output signal (parallel I/O)
		HIGH	HIGH output signal (parallel I/O)
		PASS	PASS output signal (parallel I/O)
		LOW	LOW output signal (parallel I/O)
	Data slope Data window (in) Data window (out)	TASK1	TASK1 measurement results
		TASK2	TASK2 measurement results
		TASK3	TASK3 measurement results
		TASK4	TASK4 measurement results

4 Set the trigger condition.

- When the trigger target is "Data slope"



Item	Setting item	Range	Description
Trigger condition	Condition	=	When the measurement results are the same value as the judgment value, the trigger condition is considered to have been met.
		≠	When the measurement results are a different value from the judgment value, the trigger condition is considered to have been met.
		>	When the measurement results are greater than the judgment value, the trigger condition is considered to have been met.
		≥	When the measurement results are greater than or equal to the judgment value, the trigger condition is considered to have been met.
		<	When the measurement results are less than the judgment value, the trigger condition is considered to have been met.
	≤	When the measurement results are less than or equal to the judgment value, the trigger condition is considered to have been met.	
	Judgment	-999.999999 to 999.999999 mm	This is the judgment value for the measurement results.

- When the trigger target is "Data window (In)"



Item	Setting item	Range	Description
Trigger condition	Judgment value 1	-999.999999 to 999.999999 [mm]	When the measurement results are greater than or equal to judgment value 1 and less than or equal to judgment value 2, the trigger condition is considered to have been met.
	Judgment value 2	-999.999999 to 999.999999 [mm]	

- When the trigger target is "Data window (out)"

Item	Setting item	Range	Description
Trigger condition	Judgment value 1	-999.999999 to 999.999999 [mm]	When the measurement results are less than judgment value 1 or greater than judgment value 2, the trigger condition is considered to have been met.
	Judgment value 2	-999.999999 to 999.999999 [mm]	

- When the trigger target is "Input and output"



Item	Setting item	Range	Description
Trigger condition	Condition	TRUE (rising)	When the I/O signal rises, the trigger condition is considered to have been met.
		False (falling)	When the I/O signal falls, the trigger condition is considered to have been met.

Starting and ending sampling before and after the trigger condition is met

You can adjust how long to start or end the sampling before or after the condition for starting and ending sampling is met.

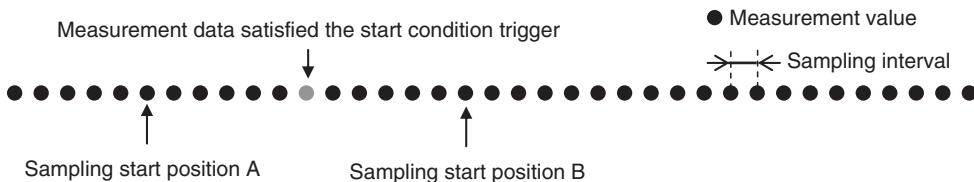

- Sampling start position A
To start sampling before the time when the trigger start condition is met, input a negative value for the delay time.
- Sampling start position B
To end sampling after the time when the trigger end condition is met, input a positive value for the delay time.

1 Input the delay time.



Item	Setting item	Range	Description
Trigger condition	Delay time	-999.999999 to 999.999999 mm	The sampling starts or ends at the time shifted by the set time from when the trigger condition is met.

5-2 Saving measured values in a file

Data sampled with the trend monitor can be exported and imported as a CSV format file.

Outputting the results of sampling as a file

Sampled measured values can be saved as a CSV format file.

A file is prepared each time the trigger condition is met.

- 1 Check the checkbox for the save destination.
- 2 Set the save condition.

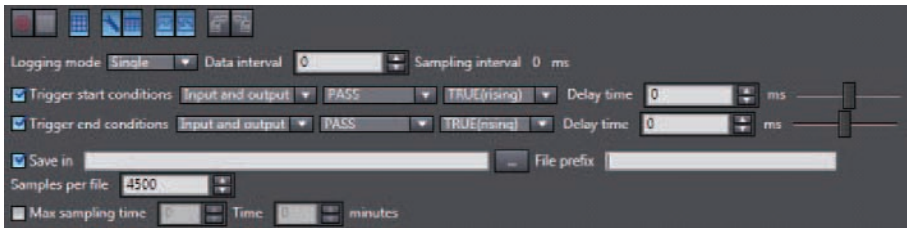

Item	Setting item	Range	Description
File settings	Logging mode	Single	When the trigger end condition is met, sampling stops.
		Continuous	Sampling does not stop until you press the End icon. Each time the trigger start condition is met, a new file is prepared and saved.
	Save in	-	This is the folder to save the files in.
	File prefix	-	This is the prefix for the name of the file saved.
	Samples per file	100 to 10000000	This is the number of samples saved in one file. If more samples than this set number are taken, a new file is prepared.
	Max sampling time	0:0:0 to 24:59:59	This indicates the upper limit on the interval for saving a file.

Exporting the results of sampling

Sampled measured values can be exported as a CSV format file.

Item	Output items	Description
LoggingMode	Single Continuous	Indicates the sampling mode. Single or continuous
SamplePeriod	1 to 9999	Indicates the sampling interval.
TriggerStart	True False	Indicates whether the trigger start condition is "Enabled" or "Disabled".
TriggerStartType	IO DataSlope DataWindowIn DataWindowOut DataSize	Indicates the trigger start condition. IO: I/O result DataSlope: Data slope DataWindowIn: Data window (in) DataWindowOut: Data window (out)

Item	Output items	Description
TriggerStartObject	TASK1 TASK2 TASK3 TASK4 TIMING ZERO BUSY ENABLE HIGH PASS LOW	Indicates the target data for the trigger start condition.
TriggerStartConditions	EqualTo NotEqualTo AndMore MoreThan LessThan AndLess True (rising) False (falling)	Indicates the trigger start condition. EqualTo: = NotEqualTo: ≠ AndMore: ≥ MoreThan: > LessThan: < AndLess: ≤ True: Rising False: Falling
TriggerStartValue1	-999.999999 to 999.999999 mm	Indicates the judgment value for the trigger start condition. For data window (in/out), indicates the lower limit.
TriggerStartValue2	-999.999999 to 999.999999 mm	Indicates the judgment value for the trigger start condition. For data window (in/out), indicates the upper limit.
TriggerStartDelay	-999.999999 to 999.999999 mm	Indicates the delay time for the trigger start condition.
TriggerEnd	True False	Indicates whether the trigger end condition is "Enabled" or "Disabled".
TriggerEndType	IO DataSlope DataWindowIn DataWindowOut DataSize	Indicates the trigger end condition. IO: I/O result DataSlope: Data slope DataWindowIn: Data window (in) DataWindowOut: Data window (out) DataSize: Number of data points
TriggerEndObject	TASK1 TASK2 TASK3 TASK4 TIMING ZERO BUSY ENABLE HIGH PASS LOW	Indicates the target data for the trigger end condition.
TriggerEndConditions	EqualTo NotEqualTo AndMore MoreThan LessThan AndLess True (rising) False (falling)	Indicates the trigger end condition. EqualTo: = NotEqualTo: ≠ AndMore: ≥ MoreThan: > LessThan: < AndLess: ≤ True: Rising False: Falling
TriggerEndValue1	-999.999999 to 999.999999 mm	Indicates the judgment value for the trigger end condition. For data window (in/out), indicates the lower limit.
TriggerEndValue2	-999.999999 to 999.999999 mm	Indicates the judgment value for the trigger end condition. For data window (in/out), indicates the upper limit.
TriggerEndDelay	-999.999999 to 999.999999 mm	Indicates the delay time for the trigger end condition.
MaxSamplesPerFile	1 to 999999999	Indicates the number of samples in one file.
TargetDirectory		Indicates where the file is stored.
FilePrefix		Indicates the prefix.

- ▶ **Explorer pane** : [(ZW model name)] (double click)
- **Edit pane** : [Online] icon (⚡)
- **Online setting window** : [Trend Monitor]

- 1 Select [Trend Monitor].**
The Trend Monitor window starts up.
- 2 Execute the sampling.**

Note

 6-1 Parallel I/O connection p.134

- 3 After sampling execution, click the export icon (⏏).**
- 4 Set the name of the export file.**

The data is output in the following format.

LoggingMode	Single
SamplePeriod	0:0:1:0:0
TriggerStart	True
TriggerStartType	DataSlope
TriggerStartObject	TASK1
TriggerStartConditions	EqualTo
TriggerStartValue1	1.1
TriggerStartValue2	
TriggerStartDelay	0
TriggerEnd	True
TriggerEndType	DataWindowIn
TriggerEndObject	TASK2
TriggerEndConditions	
TriggerEndValue1	-0.5
TriggerEndValue2	0.5
TriggerEndDelay	0
ExternalFileStorage	FALSE
MaxSamplesPerFile	4500
TargetDirectory	C:\Omron\Data\DataTrace\
FilePrefix	

Index	(DataName1)	(DataName2)
1	1.21314	1.21314
2	1.22098	1.22098
3	0.12334	0.12334
4	-0.1211	-0.1211
5	-1.23456	-1.23456
6	-1.22222	-1.22222

5-3 Displaying saved measured values

You can import a file to which measured values were exported and display those sampling results as a graph.

- ▶ **Explorer pane** : [(ZW model name)] (double click)
 - **Edit pane** : [Online] icon (⚡)
 - **Online setting window** : [Trend Monitor]

- 1 Select [Trend Monitor].**
The Trend Monitor window starts up.
- 2 Click the import icon (📄).**
- 3 Select the file to import.**
The file is imported and a graph displayed.

5-4 Performing internal logging

Up to 12,800 x 4tasks measured data can be logged in the Sensor Controller's internal memory.

Item	Output items	Description
LoggingMode	Internal	Indicates the internal logging.
SamplePeriod	1 to 99999	Indicates the storage interval.

- ▶ **Explorer pane** : [(ZW model name)] (double click)
- **Edit pane** : [Online] icon (🔌)
- **Online setting window** : [Internal Logging]

1 Set the logging conditions.

Select the [Preservation interval], [logging data count], and the TASK to store the data for.

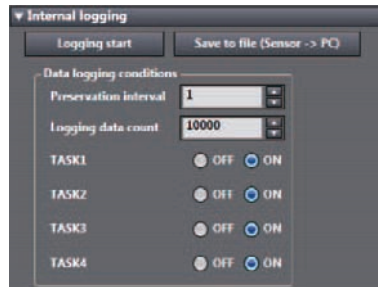

Item	Setting item	Range	Description
Data logging conditions	Preservation intervals	1 to 99999	Set the data storage interval. If "1" is set, all measured data is stored, and "2" is set, one measurement value is stored every two measurement.
	Logging data count	1 to 12800	Set the number of data points to store for each TASK.
	TASK1	OFF/ON	Set whether to store the measurement results for TASK 1.
	TASK2	OFF/ON	Set whether to store the measurement results for TASK 2.
	TASK3	OFF/ON	Set whether to store the measurement results for TASK 3.
	TASK4	OFF/ON	Set whether to store the measurement results for TASK 4.

2 Click the [Logging start] to start internal logging.

A confirmation message is displayed. Click [Yes] to start internal logging.

Note

Starting internal logging can also be executed by No-protocol communications or parallel I/O.

3 After internal logging ends, click the [Save to file (Sensor → PC)] to output the data to a file.

A CSV format file in the following format is output.

LoggingMode	Internal			
SamplePeriod	1			
Index	Task1	Task2	Task3	Task4
0	1.21314	1.21314	1.21314	1.21314
1	1.22098	1.22098	1.22098	1.22098
2	0.12334	0.12334	0.12334	0.12334
3	-0.1211	-0.1211	-0.1211	-0.1211
4	-1.23456	-1.23456	-1.23456	-1.23456
5	-1.22222	-1.22222	-1.22222	-1.22222

5-5 Storing the light reception wave form in a file

The light reception wave form can be stored in a file as a record of the measurement state.

Item	Output items	Description
RegionNo	Area1 / Area2	Indicates the measurement area. Area1: Measurement Area 1 Area2: Measurement Area 2
StartPosition	0 to 255	Indicates the start position for the measurement area.
EndPosition	0 to 255	Indicates the end position for the measurement area.

► **Explorer pane** : [Bank] | [(Bank Data Name)] (double click)

1 Select the line bright storage icon ().

Input the name of the file to export to.

A CSV format file in the following format is output.

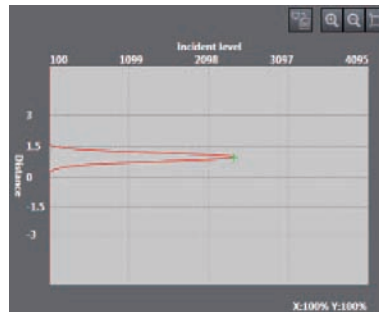

• For Area 1 mode

RegionNo	Area1
StartPosition	(Display area start point)
EndPosition	(Display area end point)
Position	Value
0	(Amount of light received 0)
1	(Amount of light received 1)
2	(Amount of light received 2)
3	(Amount of light received 3)
:	:
254	(Amount of light received 254)
255	(Amount of light received 255)

• For Area 2 mode

RegionNo	Area1	Area2
StartPosition	(Display area start point)	(Display area start point)
EndPosition	(Display area end point)	(Display area end point)
Position	Value	Value
0	(Amount of light received 0)	(Amount of light received 0)
1	(Amount of light received 1)	(Amount of light received 1)
2	(Amount of light received 2)	(Amount of light received 2)
3	(Amount of light received 3)	(Amount of light received 3)
:	:	:
254	(Amount of light received 254)	(Amount of light received 254)
255	(Amount of light received 255)	(Amount of light received 255)

5-6 Recovering calibration ROM data

If an abnormality occurs in the sensor's calibration ROM, you can recover the backed up calibration ROM data into the sensor.

1 Set the operating mode to the FUN mode.

 3-3 Switching operation modes p.57

► **Explorer pane** : [Device Group] | [(Sensor Name)] (double click)
→ **Edit pane** : [Tool] icon 

2 Click the [ROM recovery] in [Sensor setup]. Select the calibration ROM backup data file.

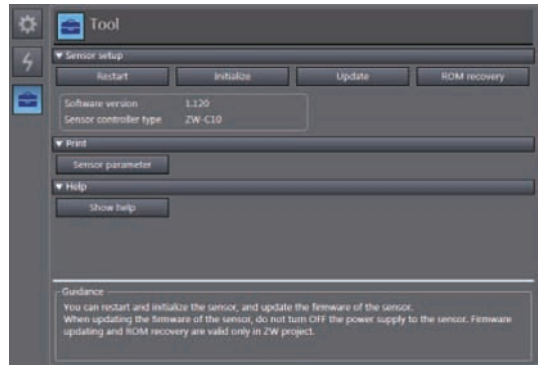

Important

The calibration ROM data is different for each sensor serial number. Select the backup file that matches the sensor serial number. Measurement will not be correct unless they match.

5-7 Printing the contents of settings

You can print the contents of bank data and system data settings.

Item	Setting item	Mode	Description
Print	Target data	All information	The sensor information, bank group data, and system data are all printed.
		Sensor information	The sensor information is printed.
		Bank Group	The bank group data (Banks 1 through 8) is printed.
		Bank	The specified bank data is printed.
		System	The system data is printed.
	Bank number	1 to 8	If bank data is selected as target data, specify the bank number to print the data for.

► **Explorer pane** : [Device Group] | [(Sensor Name)] (right-click)

1 Select [Print].

The [Print] window is displayed on the Edit pane.

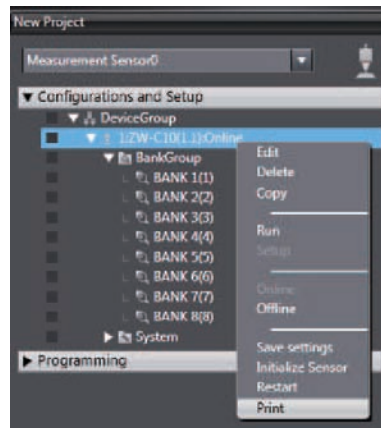

2 Select the data to print.

From [Target data], select the data to print. Select and expand the parameters to print.

If you click [Expand All], all the parameters are expanded.

To print the default values as well, check the [Display Default Values] checkbox.

Important

Only the expanded parameters are printed.

5-8 Controll input signal with PC tool

Following input signal can be controlled with PC tool.

- LED-OFF
- TIMING
- RESET
- ZERO

► **Explorer pane** : [Bank] | [(Bank data Name)] (double click)
→ **Edit pane** : [/I/O input]

1 Select ON from [/I/O input].

2 If the button is clicked, the Sensor Controller is controlled as corresponding input signal is turned ON.

While the button is clicked, corresponding input signal is status ON.

If the button is clicked again, the input signal is turned OFF.

Button	Effect
LED-OFF	The measurement LED is turned OFF.
TIMING	The TIMING input is turned ON.
RESET	The RESET input is turned ON.
ZERO	The ZERO input is turned ON.

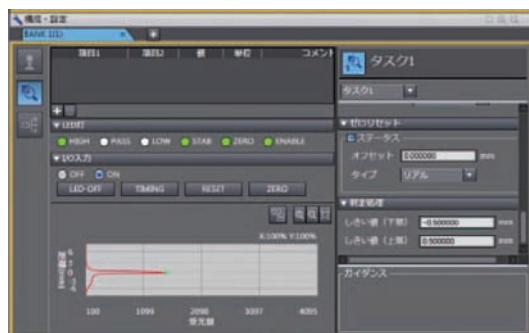

MEMO

Communications with External Devices

6-1 Parallel I/O connection	134
6-2 No-protocol Connection	169

6-1 Parallel I/O connection

I/O Signal Functions

The following describes the functions of I/O signals.

20-pole terminal block

Analog output

Name	Description
Analog voltage output	This outputs the measured value from -10 V to +10 V as the voltage value. When measurement not possible: Approx. 10.8V (default value, can be selected by user) At alarm: Approx. 10.8V
Analog current output	This outputs the measured value, from 4 mA to 20 mA as the current value. When measurement not possible: Approx. 21 mA (default value, can be selected by user) At alarm: Approx. 21 mA

Judgment output

Name	Description
HIGH output	Judgment result HIGH (HIGH threshold value < measured value) is output.
PASS Output	Judgment result PASS (LOW threshold value \leq measured value \leq HIGH threshold value) is output.
LOW output	Judgment result LOW (LOW threshold value > measured value) is output.

ALARM output

Name	Description
ALARM output	This turns ON when there is a system error.

BUSY output

Name	Description
BUSY output	This turns ON during sampling with the hold function enabled. It allows you to check whether or not the self-trigger is functioning correctly. It also turns ON during bank switching.

ENABLE output

Name	Description
ENABLE output	This turns ON when the sensor is ready for measurement. This output is interlocked with the ENABLE indicator.

ZERO input

Name	Description
ZERO input	This is used to execute and clear a zero reset.

RESET input

Name	Description
RESET input	This resets all executing measurements and outputs. While a RESET is being input, judgment output conforms to the non-measurement setting. If this RESET input switches ON while the hold function is used, the state in effect before the hold function was set will be restored.

TIMING input

Name	Description
TIMING input	This timing input is for signal input from external devices. Use it for hold function timing.

LED OFF input

Name	Description
LED OFF input	Turn off the measurement LED. While LED OFF is being input, the analog output, binary output and judgment output conform to the non-measurement setting.

52-pole expansion connector**Binary output**

Name	Description
LED OFF input	BINARY output This outputs the measurement result or judgment value as binary. The measured value is output converted to 21 bits of binary data. All the task judgment results can be output together.

GATE signal output

Name	Description
GATE output	This is the timing signal for taking in binary data with external devices. When the GATE signal is ON, take in the binary data.

Bank number output

Name	Description																																				
BANK_OUT output	<p>This outputs the currently specified bank number. It expresses the bank number in combinations of BANK_OUT1, 2 and 3.</p> <table border="1"> <thead> <tr> <th>Bank Number</th> <th>BANK_OUT1</th> <th>BANK_OUT2</th> <th>BANK_OUT3</th> </tr> </thead> <tbody> <tr> <td>BANK1</td> <td>OFF</td> <td>OFF</td> <td>OFF</td> </tr> <tr> <td>BANK2</td> <td>ON</td> <td>OFF</td> <td>OFF</td> </tr> <tr> <td>BANK3</td> <td>OFF</td> <td>ON</td> <td>OFF</td> </tr> <tr> <td>BANK4</td> <td>ON</td> <td>ON</td> <td>OFF</td> </tr> <tr> <td>BANK5</td> <td>OFF</td> <td>OFF</td> <td>ON</td> </tr> <tr> <td>BANK6</td> <td>ON</td> <td>OFF</td> <td>ON</td> </tr> <tr> <td>BANK7</td> <td>OFF</td> <td>ON</td> <td>ON</td> </tr> <tr> <td>BANK8</td> <td>ON</td> <td>ON</td> <td>ON</td> </tr> </tbody> </table>	Bank Number	BANK_OUT1	BANK_OUT2	BANK_OUT3	BANK1	OFF	OFF	OFF	BANK2	ON	OFF	OFF	BANK3	OFF	ON	OFF	BANK4	ON	ON	OFF	BANK5	OFF	OFF	ON	BANK6	ON	OFF	ON	BANK7	OFF	ON	ON	BANK8	ON	ON	ON
Bank Number	BANK_OUT1	BANK_OUT2	BANK_OUT3																																		
BANK1	OFF	OFF	OFF																																		
BANK2	ON	OFF	OFF																																		
BANK3	OFF	ON	OFF																																		
BANK4	ON	ON	OFF																																		
BANK5	OFF	OFF	ON																																		
BANK6	ON	OFF	ON																																		
BANK7	OFF	ON	ON																																		
BANK8	ON	ON	ON																																		

Binary output task number output

Name	Description															
BINARY_OUT output	<p>This outputs the task number currently output as binary. It expresses the task number in combinations of BINARY_OUT1 and 2.</p> <table border="1"> <thead> <tr> <th>Task Number</th> <th>BINARY_OUT1</th> <th>BINARY_OUT2</th> </tr> </thead> <tbody> <tr> <td>TASK1</td> <td>OFF</td> <td>OFF</td> </tr> <tr> <td>TASK2</td> <td>ON</td> <td>OFF</td> </tr> <tr> <td>TASK3</td> <td>OFF</td> <td>ON</td> </tr> <tr> <td>TASK4</td> <td>ON</td> <td>ON</td> </tr> </tbody> </table>	Task Number	BINARY_OUT1	BINARY_OUT2	TASK1	OFF	OFF	TASK2	ON	OFF	TASK3	OFF	ON	TASK4	ON	ON
Task Number	BINARY_OUT1	BINARY_OUT2														
TASK1	OFF	OFF														
TASK2	ON	OFF														
TASK3	OFF	ON														
TASK4	ON	ON														

Binary output object task selection input

Name	Description															
BINARY_SEL input	<p>This selects which task's data is output as binary. Specify the task number in combinations of BINARY_SEL1 and 2. It is only enabled in RUN mode.</p> <table border="1"> <thead> <tr> <th>Task Number</th> <th>BINARY_SEL1</th> <th>BINARY_SEL2</th> </tr> </thead> <tbody> <tr> <td>TASK1</td> <td>OFF</td> <td>OFF</td> </tr> <tr> <td>TASK2</td> <td>ON</td> <td>OFF</td> </tr> <tr> <td>TASK3</td> <td>OFF</td> <td>ON</td> </tr> <tr> <td>TASK4</td> <td>ON</td> <td>ON</td> </tr> </tbody> </table>	Task Number	BINARY_SEL1	BINARY_SEL2	TASK1	OFF	OFF	TASK2	ON	OFF	TASK3	OFF	ON	TASK4	ON	ON
Task Number	BINARY_SEL1	BINARY_SEL2														
TASK1	OFF	OFF														
TASK2	ON	OFF														
TASK3	OFF	ON														
TASK4	ON	ON														

Bank selection input

Name	Description																																				
BANK_SEL input	<p>This is used for switching banks. Specify the bank number in combinations of BANK_SEL1, 2 and 3. However, if the bank mode is set to "JUDGEMENT", the bank cannot be switched at the external signal input because the number of banks increases to 32.</p> <table border="1"><thead><tr><th>Bank Number</th><th>BANK_SEL1</th><th>BANK_SEL2</th><th>BANK_SEL3</th></tr></thead><tbody><tr><td>BANK1</td><td>OFF</td><td>OFF</td><td>OFF</td></tr><tr><td>BANK2</td><td>ON</td><td>OFF</td><td>OFF</td></tr><tr><td>BANK3</td><td>OFF</td><td>ON</td><td>OFF</td></tr><tr><td>BANK4</td><td>ON</td><td>ON</td><td>OFF</td></tr><tr><td>BANK5</td><td>OFF</td><td>OFF</td><td>ON</td></tr><tr><td>BANK6</td><td>ON</td><td>OFF</td><td>ON</td></tr><tr><td>BANK7</td><td>OFF</td><td>ON</td><td>ON</td></tr><tr><td>BANK8</td><td>ON</td><td>ON</td><td>ON</td></tr></tbody></table>	Bank Number	BANK_SEL1	BANK_SEL2	BANK_SEL3	BANK1	OFF	OFF	OFF	BANK2	ON	OFF	OFF	BANK3	OFF	ON	OFF	BANK4	ON	ON	OFF	BANK5	OFF	OFF	ON	BANK6	ON	OFF	ON	BANK7	OFF	ON	ON	BANK8	ON	ON	ON
Bank Number	BANK_SEL1	BANK_SEL2	BANK_SEL3																																		
BANK1	OFF	OFF	OFF																																		
BANK2	ON	OFF	OFF																																		
BANK3	OFF	ON	OFF																																		
BANK4	ON	ON	OFF																																		
BANK5	OFF	OFF	ON																																		
BANK6	ON	OFF	ON																																		
BANK7	OFF	ON	ON																																		
BANK8	ON	ON	ON																																		

LOGGING input

Name	Description
LOGGING input	This is used to start internal logging.

Settings for Analog Output

The following describes the settings for outputting the current measurement results from the analog output of the 20-pole terminal block.

Setting the analog output destination

With analog output, the measurement results can be output converted to a current from 4 to 20 mA or a voltage from -10 to +10 V.

Selects which to output, the current or the voltage.

Important

The same output destination is set for all banks. The output destination cannot be set separately for individual banks.

Item	Setting item	Setting value	Description
Sensor settings	Analog output	Voltage output (default value)	Voltage output
		Current output	Current output

1 Set the operating mode to the FUN mode.

 3-3 Switching operation modes p.57

- **Explorer pane** : [Device Group] | [(Sensor Name)] | [System] | [System Data] (double-click)
- **Edit pane** : [Sensor settings] icon ()

2 Select the output destination from [Analog output].

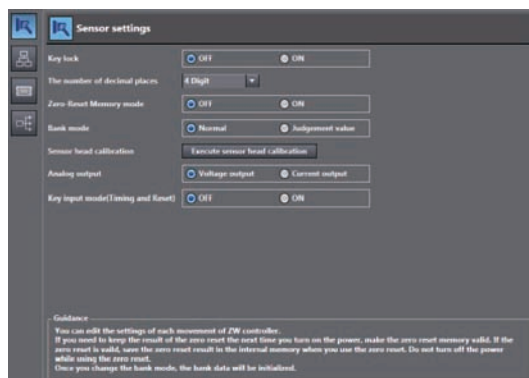

Note

The analog output destination can also be set with key operations on the Sensor Controller.

 Setting the analog output destination p.264

Assigning Analog Output

Set the task for which to output the results as analog.

Item	Setting item	Setting value	Description
Analog output	Output object	None/TASK1/TASK2/TASK3/TASK4	Select the task to output as analog.

1 Set the operating mode to the FUN mode.

 3-3 Switching operation modes p.57

- ▶ **Explorer pane** : [Bank] | [(Bank Data Name)] (double click)
- **Edit pane** : [I/O Settings] icon 
- **I/O Setting Screen** : [Analog output]

2 Select the task from [Output object].

You can select from the above setting values.

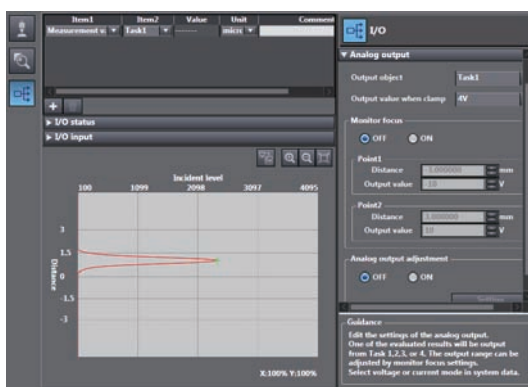

Note

Analog output can also be assigned with key operations on the Sensor Controller.

 Assigning Analog Output p.265

Setting Monitor Focus

With analog output, the relationship between the output value and measured value to be displayed can be set as desired to convert the measurement result to 4 to 20 mA current or -10 to +10 V voltage before output.

Set the focus to match the connected external device.

The output range can be set by entering the output value for the current or voltage values for any two points.

Example: When setting 4 mA output (1st point) for measured value of 0 mm and 20 mA output for measured value of 6 mm (2nd point) (current output)

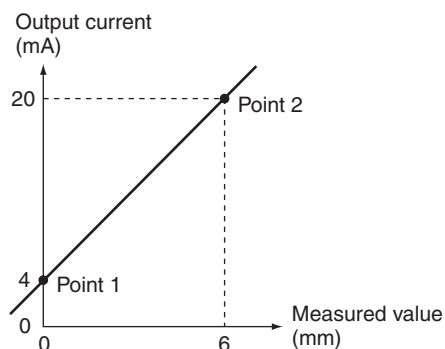

Important

Separate the two specified points by at least 1% of the rated measuring range of the connected Sensor Head or 40 μm .

For example, for the ZW-S40, the two measured points must be separated by at least $12 \text{ mm} \times 0.01 = 0.12 \text{ mm}$ as the measuring range is $12 \text{ mm} (\pm 6 \text{ mm})$.

Item	Setting item	Setting value	Description	
Monitor focus	Monitor focus	ON/OFF (default value)	Sets monitor focus ON/OFF.	
	Point1	Distance value	-999.999999 to -3.000000 (default value) to 999.999999 [mm]	Sets the reference measured value for output.
		Current output value	4 (default value) to 20 [mA]	When the analog output destination is set to current, sets the current to be output when the distance value is measured.
		Voltage output value	-10 (default value) to 10 [V]	When the analog output destination is set to voltage, sets the voltage to be output when the distance value is measured.
	Point2	Distance value	-999.999999 to 3.000000 (default value) to 999.999999 [mm]	Sets the reference measured value for output.
		Current output value	4 (default value) to 20 [mA]	When the analog output destination is set to current, sets the current to be output when the distance value is measured.
Voltage output value		-10 (default value) to 10 [V]	When the analog output destination is set to voltage, sets the voltage to be output when the distance value is measured.	

Note

The monitor focus can also be set with key operations on the Sensor Controller.

 Setting Monitor Focus p.265

1 Set the operating mode to the FUN mode.

 3-3 Switching operation modes p.57

- ▶ Explorer pane : [Bank] | [(Bank Data Name)] (double click)
- Edit pane : [I/O Settings] icon 
- I/O Setting Screen : [Analog output]

2 Select ON/OFF from [Monitor Focus].

3 Enter the [Distance] and [Output value] at [Point1].

4 Likewise, enter the [Distance] and [Output value] at [Point2].

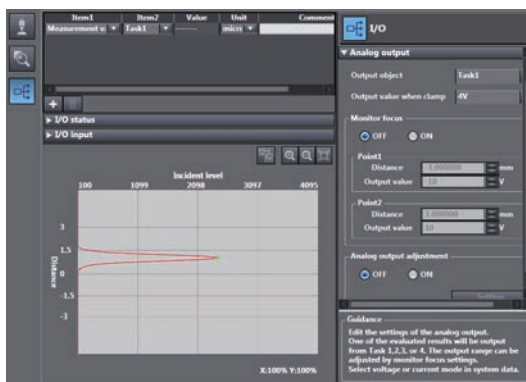

Adjusting the analog output value

Discrepancies may occur between the current value/voltage value output as analog set on the Sensor Controller and the current value/voltage value actually measured due to the conditions for the connected external device or other factors.

The analog output adjustment function can be used to correct this discrepancy.

The output values are corrected by entering the adjustment value for the current or voltage values for any two points.

Important

Set the output destination and select either current or voltage output beforehand. Also, connect the analog output signal line to an external ammeter or voltmeter.

Item	Setting item	Setting value	Description	
Analog output adjustment	Analog output adjustment		ON/OFF (default value)	Set analog output correction ON/OFF.
	Point1	Reference value (current/voltage)	4 to 20 [mA]/-10 to 10 [V]	Sets the current or voltage to be used as the correction reference in the entry field on the left.
		adjustment value	-999 to 999	Sets the adjustment value when the reference value is measured in the entry field on the right.
	Point2	Reference value (current/voltage)	4 to 20 [mA]/-10 to 10 [V]	Sets the current or voltage to be used as the correction reference in the entry field on the left.
adjustment value		-999 to 999	Sets the adjustment value when the reference value is measured in the entry field on the right.	

1 Set the operating mode to the FUN mode.

 3-3 Switching operation modes p.57

- ▶ Explorer pane : [Bank] | [(Bank Data Name)] (double click)
- Edit pane : [I/O Settings] icon 
- I/O Setting Screen : [Analog output]

2 Select ON from [Analog output adjustment].

3 Click [Setting].

The "Analog Output Adjust" popup menu appears.

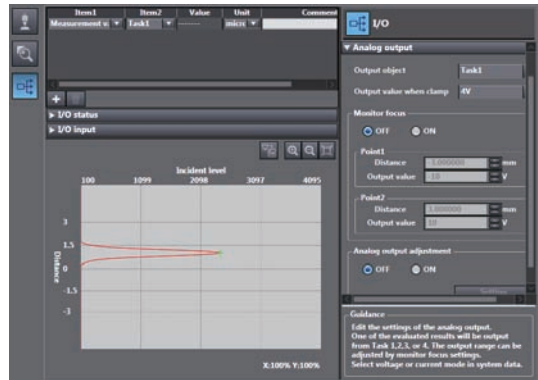

4 Enter the [Distance] and [Output value] at [Point1], and click [Output].

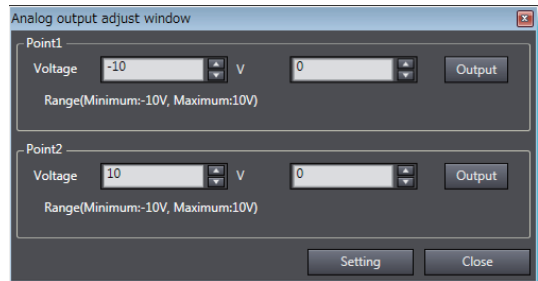

5 Likewise, enter the [Distance] and [Output value] at [Point2], and click [Output].

6 Click [Setting].

Note

Analog output values can also be adjusted with key operations on the Sensor Controller.

 Adjusting the analog output value p.267

Settings for Judgment Output

The following describes the settings for outputting the judgment results from the judgment output of the 20-pole terminal block.

Assigning judgment output

Set the task for which to output the judgment results.

The judgment results for the selected task are output from the following output terminals of the 20-pole terminal block.

HIGH1/PASS1/LOW1

Item	Setting item	Setting value	Description
Judgment	Output object	TASK1/TASK2/TASK3/TASK4	Select the task for which to output the judgment result.

1 Set the operating mode to the FUN mode.

 3-3 Switching operation modes p.57

- ▶ **Explorer pane** : [Bank] | [(Bank Data Name)] (double click)
- **Edit pane** : [I/O Settings] icon 
- **I/O Setting Screen** : [Judgment]

2 Select the task from [Output object].

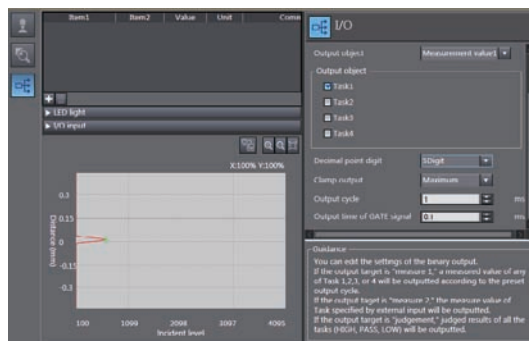

Note

Judgment output can also be assigned with key operations on the Sensor Controller.

 Assigning judgment output p.271

Setting Operation at Judgment Output

Set the hysteresis width of the judgment upper/lower limit values and judgment output timing.

 3-6 Setting Threshold Value p.64

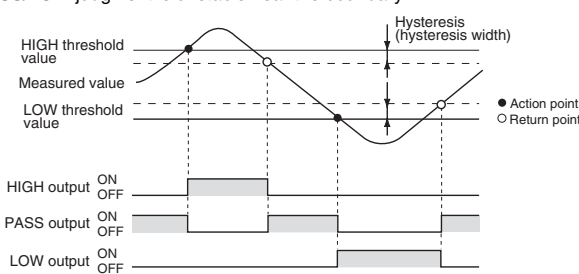
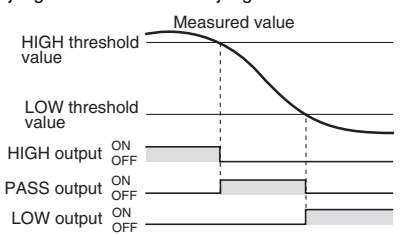
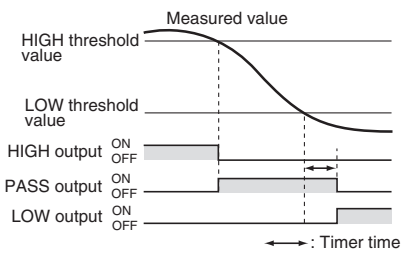
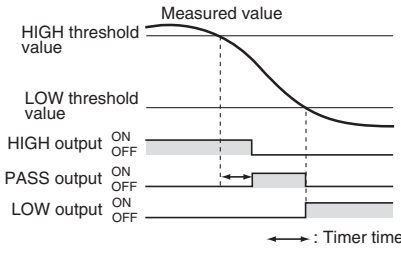
Item	Setting item	Setting value	Description
Judgment output	Hysteresis width	0 to 99.9999mm	<p>Sets the hysteresis value (difference between operating point and recovery point) of the judgment upper/lower limit values when HIGH/PASS/LOW judgment is unstable near the boundary.</p> 
	Timer mode	OFF (default value)	<p>Outputs the judgment as soon as the judgment result has been applied.</p> 
	Off Delay		<p>Delays the falling edge of the PASS output by the value set at [Timer Duration] after the judgment result has been applied.</p> 
	On Delay		<p>Delays the rising edge of the PASS output by the value set at [Timer Duration] after the judgment result has been applied.</p> 

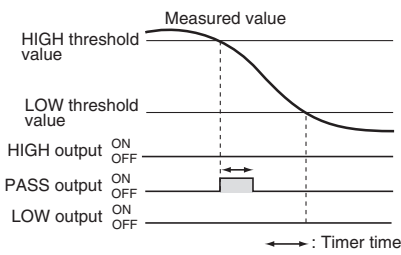
Item	Setting item	Setting value	Description
Judgment output	Timer mode	One Shot	When the judgment result changes to PASS, the PASS output is executed for the time set to [Timer Duration]. 
	Timer time	1 (default value) to 5000 [ms]	Sets the timer duration when the timer mode is other than OFF.

1 Set the operating mode to the FUN mode.

 3-3 Switching operation modes p.57

- ▶ **Explorer pane** : [Bank] | [(Bank Data Name)] (double click)
- **Edit pane** : [I/O Settings] icon 
- **I/O Setting Screen** : [Judgment]

2 Set [Hysteresis Width].

3 Select the judgment output timing to match operation of the external device from [Timer settings] - [Timer mode].

4 Sets [Timer time].

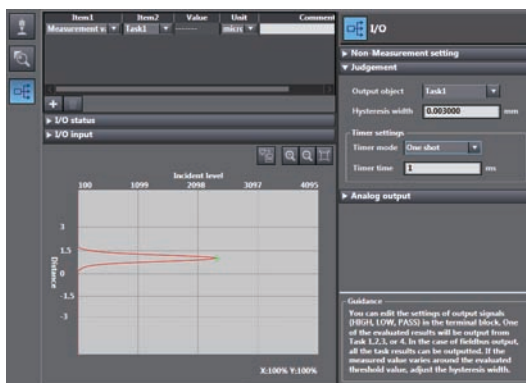

Note

The operations for judgment output can also be set with key operations on the Sensor Controller.

 Setting Operation at Judgment Output p.272

Settings for Binary Output

The following describes the settings for outputting the current measurement results and judgment values from the binary output of the 52-pole extended connector.

Output content setting

Sets the output content for binary output.

Item	Setting item	Setting value	Description
Binary output	Output object	Off (Default value)	No binary output.
		Measurement value 1	Sets whether or not there is output for each task. The measured value for the task selected here is output as binary for each measurement cycle.
		Measurement value 2	The measured value for the task selected with the BINARY_SEL input (See p.136) is output.
		Judgment value	Outputs the judgment result.

Output format

When the measured value is output

Outputs the measured value as a 21-bit binary number (2's complement).

(Example1)

When the measured value is "+1.23456" (The number of digits after the decimal point is the default (5 digits).)
123456 (decimal) → 000011110001001000000 (binary)

(Example2)

When the measured value is "-1.23456"
-123456 (decimal) → 111100001110111000000 (binary)

Note

When multiple tasks are output continuously, the currently output task number is output in the BINARY_OUT output.



Binary output task number output p.136

When the judgment is output

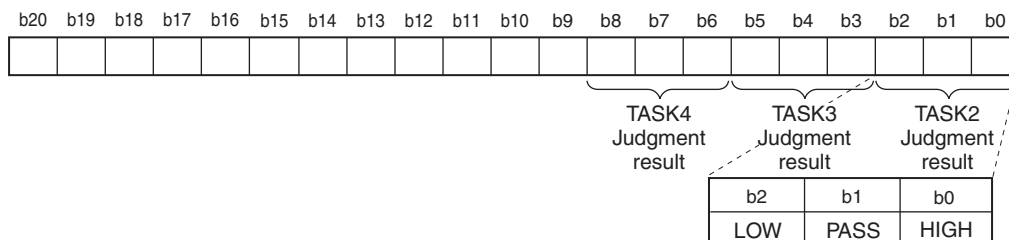

Bit	Item	Details
b0/3/6	HIGH	Turns ON when the judgment result is HIGH.
b1/4/7	PASS	Turns ON when the judgment result is PASS.
b2/5/8	LOW	Turns ON when the judgment result is LOW.

1 Set the operating mode to the FUN mode.

 3-3 Switching operation modes p.57

- ▶ **Explorer pane** : [Bank] | [(Bank Data Name)] (double click)
- **Edit pane** : [I/O Settings] icon 
- **I/O Setting Screen** : [Binary output]

2 Select the task from [Output object].

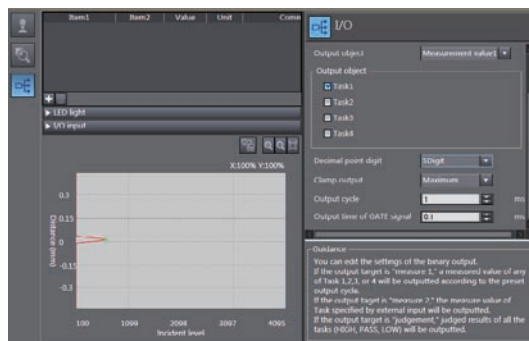

Note

Binary output can also be assigned with key operations on the Sensor Controller.

 Output Content Setting p.268

Decimal point digit setting

Sets the number of digits after the decimal point for data output as binary.

Item	Setting item	Setting value	Description
Binary output	Decimal point digit	0 digit/1 digit/2 digits/3 digits/4 digits/5 digits (Default value) /6 digits	Sets the number of digits after the decimal point for data output as binary.

Example:

If the measured value is "0.123456", the output value is as follows according to the number of digits after the decimal point.

- 0 digits: 0 (output range: 1048576 mm - 1048575 mm)
- 1 digit: 1 (output range: 104857.6 mm - 104857.5 mm)
- 2 digits: 12 (output range: 10485.76 mm - 10485.75 mm)
- 3 digits: 123 (output range: 1048.576 mm - 1048.575 mm)
- 4 digits: 1234 (output range: 104.8576 mm - 104.8575 mm)
- 5 digits: 12345 (output range: 10.48576 mm - 10.48575 mm)
- 6 digits: 123456 (output range: 1.048576 mm - 1.048575 mm)

If the measurement result is outside the output range, the output range upper or lower limit is output.

For example, if the number of digits after the decimal point is 6 and the measurement result is 2.00000 mm, the binary output value is 1048575.

If there is a measurement abnormality, the output range upper limit value is output.

1 Set the operating mode to the FUN mode.

 3-3 Switching operation modes p.57

- ▶ **Explorer pane** : [Bank] | [(Bank Data Name)] (double click)
- **Edit pane** : [I/O Settings] icon 
- **I/O Setting Screen** : [Binary output]

2 Select the decimal point digit from [Decimal point digit].

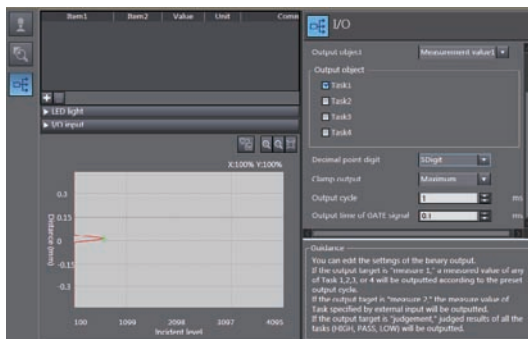

Note

Decimal point digit can also be assigned with key operations on the Sensor Controller.

 Decimal Point Digit Setting p.269

Output cycle setting

Sets the output cycle for binary output.

The output cycle can be set as an integer multiple of the measurement cycle.

Item	Setting item	Setting value	Description
Binary output	Output cycle	1 (Default value) to 100	The binary data is output at the interval "setting value × measurement cycle".

1 Set the operating mode to the FUN mode.

 3-3 Switching operation modes p.57

- ▶ **Explorer pane** : [Bank] | [(Bank Data Name)] (double click)
- **Edit pane** : [I/O Settings] icon 
- **I/O Setting Screen** : [Binary output]

2 Select the output cycle from [Output cycle].

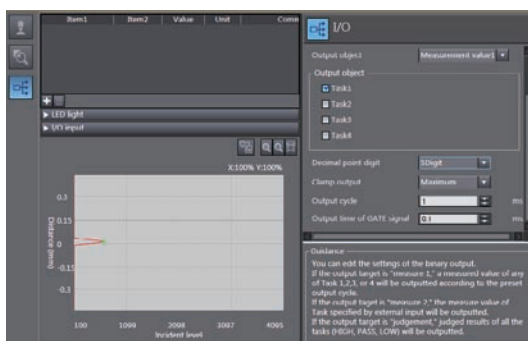

Note

Output cycle can also be assigned with key operations on the Sensor Controller.

Output cycle setting p.270

GATE signal setting

Sets the output time for the synchronization signal (GATE) for taking in signals externally.

Item	Setting item	Setting value	Description
Binary output	Output time of GATE signal	0.1 (Default value) to 100.0 ms	The GATE signal is output for the set time.

1 Set the operating mode to the FUN mode.

3-3 Switching operation modes p.57

- ▶ **Explorer pane** : [Bank] | [(Bank Data Name)] (double click)
- **Edit pane** : [I/O Settings] icon
- **I/O Setting Screen** : [Binary output]

2 Select the output time from [Output time of GATE signal].

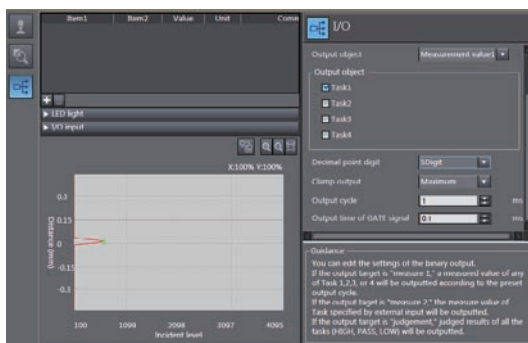

Note

GATE period can also be assigned with key operations on the Sensor Controller.

GATE signal setting p.270

Settings for Processing When Measurement Is Not Possible

Setting operation when measurement is not possible

Set the output method when the sensor head temporarily enters a non-measurement state, for example, due to insufficient received light amount or a RESET input state.

Example: When skipping occurs in the waveform due to insufficient received light intensity

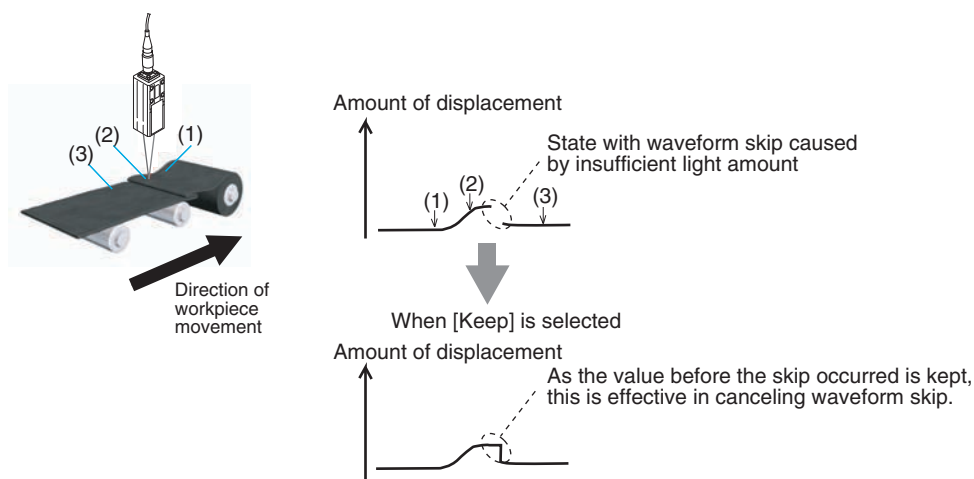

Important

When performing hold measurement, the output before the initial hold value is applied is the same as that for "Clamp" even if "Keep" is set.

Item	Setting item	Setting value	Description
Non-Measurement setting	Non-Measurement setting	Keep	The measured value before the non-measurement state was entered is held and output.
		Clamp	With analog output, the preset clamp value (abnormal value) is output. All judgment outputs become OFF.

1 Set the operating mode to the FUN mode.

3-3 Switching operation modes p.57

- ▶ **Explorer pane** : [Bank] | [(Bank Data Name)] (double click)
- **Edit pane** : [I/O Settings] icon
- **I/O Setting Screen** : [Non-Measurement Setting]

2 Select the operation during non-measurement at [Non-Measurement Setting].

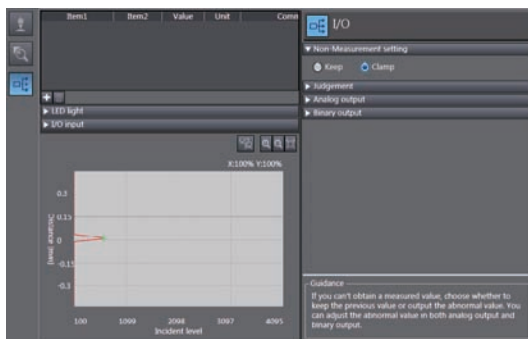

Note

The operations for when measurement is not possible can also be set with key operations on the Sensor Controller.

Setting operation when measurement is not possible p.273

Setting the Clamp Value for Analog Output

Set the clamp value to output when "Clamp" is selected as processing when measurement is not possible.

Item	Setting item	Setting value	Description
Analog output	Clamp output	When the analog output destination is set to current MIN (approx. 3.4mA)/4 to 20mA (1mA increments)/ MAX (default value: approx. 21mA) When the analog output destination is set to voltage MIN (approx. -10.8V)/-10 to 10V (1V increments)/ MAX (default value: approx. 10.8V)	Select the analog current/voltage at clamp output.

1 Set the operating mode to the FUN mode.

3-3 Switching operation modes p.57

- ▶ Explorer pane : [Bank] | [(Bank Data Name)] (double click)
- Edit pane : [I/O Settings] icon
- I/O Setting Screen : [Analog output]

2 Select the output value at [Output value when clamp].

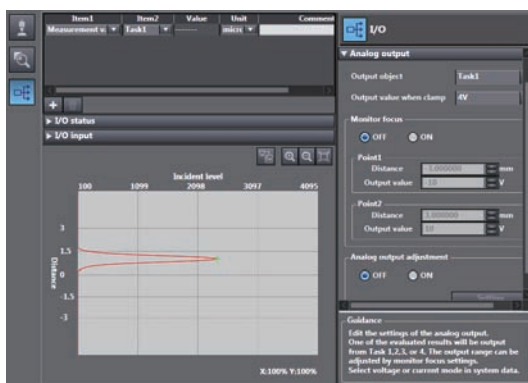

Note

Clamp values can also be set with key operations on the Sensor Controller.

 Setting the Clamp Value p.274

Setting the Clamp Value for Binary Output

Set the clamp value to output when "Clamp" is selected as processing when measurement is not possible.

Item	Setting item	Setting value	Description
Binary output	Clamp output	MIN (Default value)/MAX	Select the binary output at clamp output. MIN: -1048576 MAX: 1048575

1 Set the operating mode to the FUN mode.

 3-3 Switching operation modes p.57

- ▶ **Explorer pane** : [Bank] | [(Bank Data Name)] (double click)
- **Edit pane** : [I/O Settings] icon 
- **I/O Setting Screen** : [Binary output]

2 Select the output value at [Clamp output].

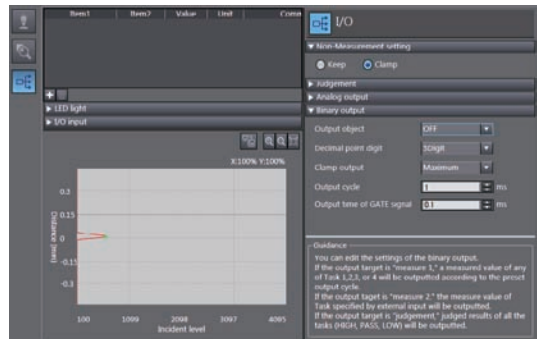
**Note**

Clamp values can also be set with key operations on the Sensor Controller.

 Setting the Clamp Value p.274

Settings for Bank Control

This section describes the settings for controlling banks by using parallel I/O.

Selecting banks

The bank is selected in combinations of the bank select input signals (BANK_SEL1 to 3).

Bank selection input 1 (BANK_SEL1)	Bank selection input 2 (BANK_SEL2)	Bank selection input 3 (BANK_SEL3)	Selected bank
OFF	OFF	OFF	BANK1
ON	OFF	OFF	BANK2
OFF	ON	OFF	BANK3
ON	ON	OFF	BANK4
OFF	OFF	ON	BANK5
ON	OFF	ON	BANK6
OFF	ON	ON	BANK7
ON	ON	ON	BANK8

Important

- Bank switching is begun 0.2 seconds after the input state changes.
- At most it takes about 100ms to switch banks.
- During bank switching, the BUSY output becomes ON.
- If the bank mode is set to [JUDGE], the bank cannot be switched at the external signal input because the number of banks increases to 32.

Outputting the currently selected bank number

The currently selected bank number is output.

The output bank number depends on the combination of the bank number output signals (BANK_OUT1 to 3).

Bank number output 1 (BANK_OUT1)	Bank number output 2 (BANK_OUT2)	Bank number output 3 (BANK_OUT3)	Output bank
OFF	OFF	OFF	BANK1
ON	OFF	OFF	BANK2
OFF	ON	OFF	BANK3
ON	ON	OFF	BANK4
OFF	OFF	ON	BANK5
ON	OFF	ON	BANK6
OFF	ON	ON	BANK7
ON	ON	ON	BANK8

Settings for Internal Logging

Set the LOGGING save count and LOGGING save intervals

The following describes the settings for internal logging.

Item	Setting item	Setting value	Description
Internal logging	LOGGING save count	0 to 12800 (default value)	Sets the maximum data count to be internally logged.
	LOGGING save intervals	0 to 1 (default value) to 1000	Sets the intervals to be internally logged. If "1" is set, all measured data is stored, and "2" is set, one measured data is stored every two measurement. If "0" is set, only the applied measured data is stored when hold is set.

Important

- This settings are not applied when internal logging is started by sending No-protocol communications or the operating keys on the Sensor Controller.
- It cannot set and display using Sysmac Studio.

Note

The setting of LOGGING save count and LOGGING save intervals can also be set by the operating keys on the Sensor Controller.



Setting for Internal Logging p.275

Timing Chart

The following shows the timing charts when communication is performed with external devices.

Basic operation

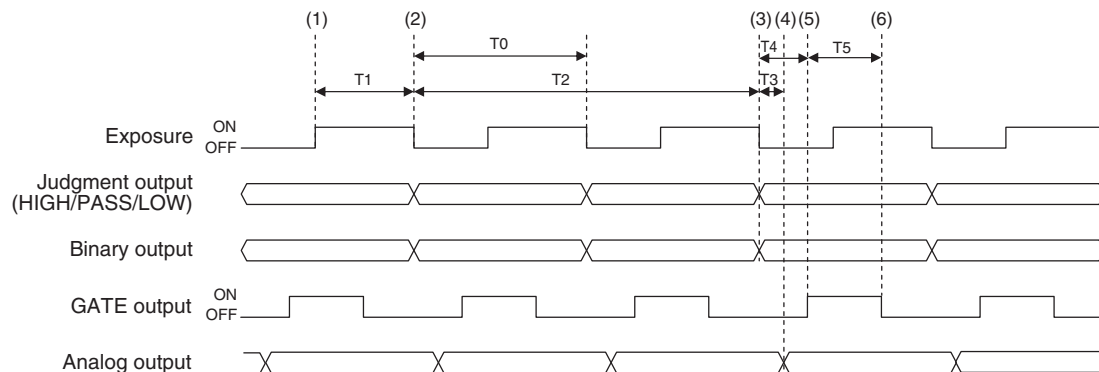

Item		Min.	Max.
T0	Measuring cycle	0.5 ms	Depends on the set conditions (0.5 to 10.0 ms)
T1	Exposure time	1 μ s	Max. exposure time (1 to 5000 μ s)
T2	Response time of output	$T0 \times 2$	$T0 \times 2$
T3	Response time of analog output	–	0.1 ms
T4	GATE signal rise time	–	0.2 ms
T5	GATE signal output time	Setting value (0.1 to 100.0 ms)	Setting value (0.1 to 100.0 ms)

Explanation of operations

- (1) During each sampling cycle, the LEDs are lit up and exposure is started.
- (2) After the end of exposure, measurement starts.
- (3) After the end of measurement, the judgment results and binary data are output.
- (4) After the judgment results and binary data are output, the analog output is updated.
- (5) After the judgment results and binary data are output, the GATE output is turned ON.
- (6) The GATE signal output time after the GATE output is turned ON, the GATE output is turned OFF.

Hold (peak/bottom/peak to peak/average)

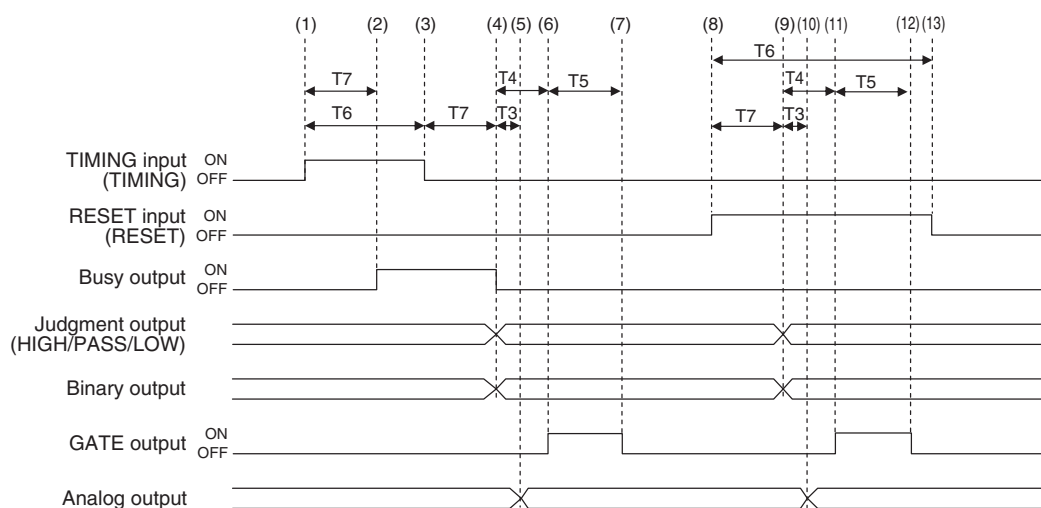

Item		Min.	Max.
T3	Response time of analog output	–	0.1 ms
T4	GATE signal rise time	–	0.2 ms
T5	GATE signal output time	Setting value (0.1 to 100.0 ms)	Setting value (0.1 to 100.0 ms)
T6	TIMING input/RESET input minimum time	3 ms+T0	–
T7	Response time of input	2 ms+T0	3 ms+T0×2

Explanation of operations

- (1) The TIMING input is turned ON.
- (2) During the TIMING input minimum time, when the TIMING input is ON, sampling is started and the BUSY output is turned ON.
- (3) After the end of measurement, the judgment results and binary data are output.
- (4) After the TIMING input goes OFF, sampling is ended and the judgment results and binary data are output. The BUSY output is also turned OFF.
- (5) After the judgment result and binary data output, the analog output is updated.
- (6) After the judgment result and binary data output, the GATE signal is turned ON.
- (7) The GATE signal output time after the GATE output is turned ON, the GATE output is turned OFF.
- (8) The GATE signal output is turned ON. During the GATE signal output minimum time, if the GATE signal output is turned ON, the measured value is reset.
- (9) The judgment results and binary data are reset.
- (10) After the judgment results and binary data are reset, the analog output is reset.
- (11) After the judgment results and binary data are reset, the GATE output is turned ON.
- (12) The GATE signal output time after the GATE output is turned ON, the GATE signal is turned OFF.
- (13) The RESET input is turned OFF.

Important

When the setting for non-measurement is "CLAMP", if the sampling value is an abnormal value or an undetermined value *, sampling is not executed. If sampling has been started, it is stopped. The output value is as follows.

- Hold the clamp value.
- If the previous hold value is not the clamp value, the GATE signal is output.

To start and continue sampling even if a sampling value is an abnormal value or an undetermined value, set "KEEP" as the non-measurement setting.

*: After the start of measurement, if measurement results are not obtained the number of times required to take the average, the measurement result is not applied.

Hold (auto peak/auto bottom/auto peak-to-peak)

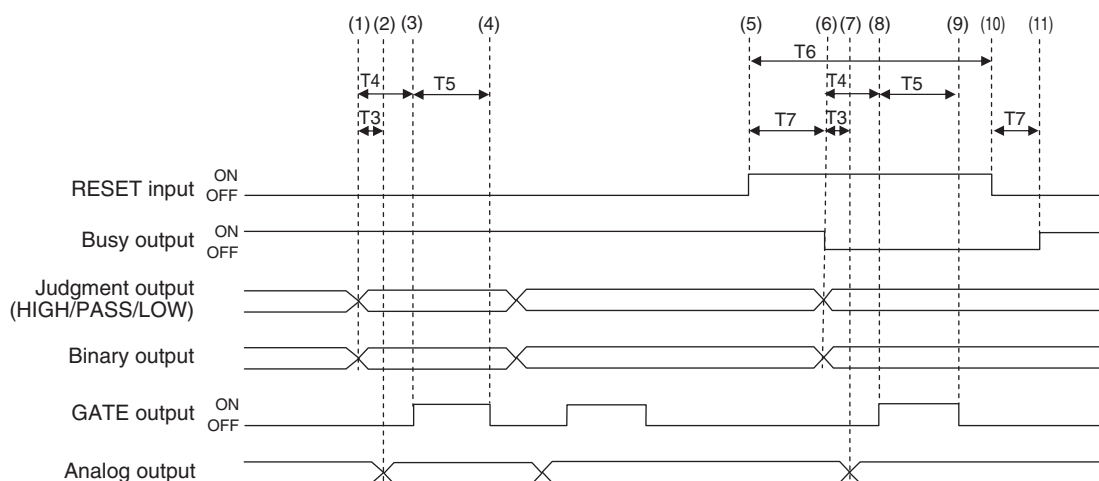

Item		Min.	Max.
T3	Response time of analog output	–	0.1 ms
T4	GATE signal rise time	–	0.2 ms
T5	GATE signal output time	Setting value (0.1 to 100.0 ms)	Setting value (0.1 to 100.0 ms)
T6	TIMING input/RESET input minimum time	3 ms+T0	–
T7	Input response time	2 ms+T0	3 ms+T0×2

Explanation of operations

- (1) The peak value is updated and the judgment results and binary data are output.
- (2) After the judgment result and binary data output, the analog output is updated.
- (3) After the judgment result and binary data output, the GATE output is turned ON.
- (4) The GATE signal output time after the GATE output is turned ON, the GATE output is turned OFF.
- (5) The RESET input is turned ON. During the RESET input minimum time, if the RESET input is turned ON, the measured value is reset.
- (6) The judgment results and binary data are reset. The BUSY output is turned OFF.
- (7) After the judgment results and binary data are reset, the analog output is reset.
- (8) After the judgment result and binary data output, the GATE output is turned ON.
- (9) The GATE signal output time after the GATE output is turned ON, the GATE output is turned OFF.
- (10) The RESET input is turned OFF.
- (11) The BUSY output is turned ON.

Important

When the setting for non-measurement is "CLAMP", if the sampling value is an abnormal value or an undetermined value *, sampling is not executed. If sampling has been started, it is stopped. The output value is as follows.

- Hold the clamp value.
- If the previous hold value is not the clamp value, the GATE signal is output.
- The BUSY signal is turned OFF.

To start and continue sampling even if a sampling value is an abnormal value or an undetermined value, set "KEEP" as the non-measurement setting.

*: After the start of measurement, if measurement results are not obtained the number of times required to take the average, the measurement result is not applied.

Hold (sampling)

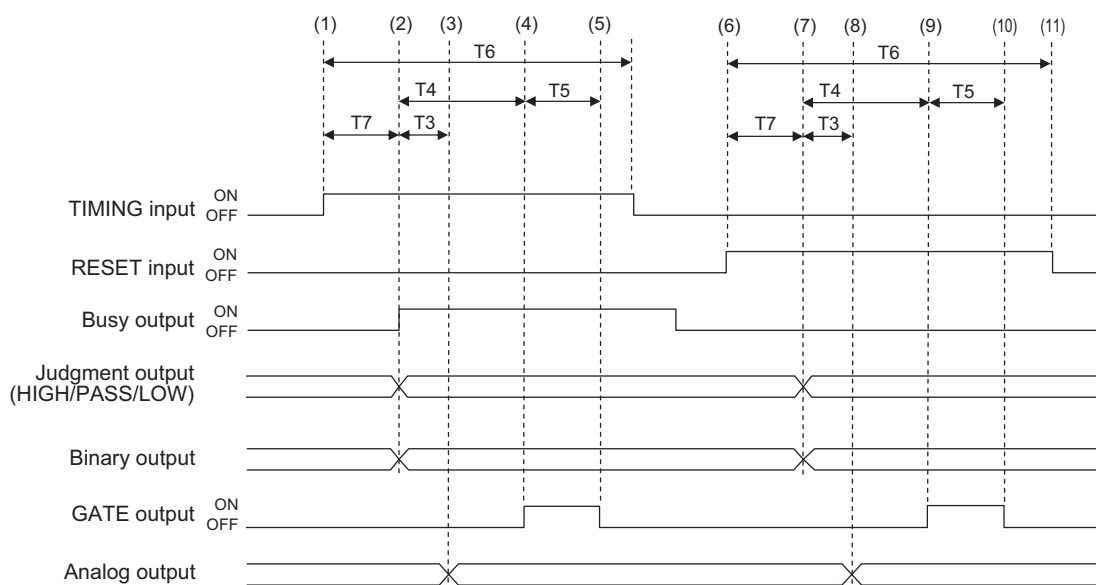

Item		Min.	Max.
T3	Response time of analog output	–	0.1 ms
T4	GATE signal rise time	–	0.2 ms
T5	GATE signal output time	Setting value (0.1 to 100.0 ms)	Setting value (0.1 to 100.0 ms)
T6	TIMING input/RESET input minimum time	3 ms+T0	–
T7	Input response time	2 ms+T0	3 ms+T0 × 2

Explanation of operations

- (1) The TIMING input is turned ON.
- (2) During the TIMING input minimum time, when the TIMING input is ON, sampling is started and the BUSY output is turned ON. The measurement results are sampled and the judgment results and binary data are output.
- (3) After the judgment result and binary data output, the analog output is updated.
- (4) After the judgment result and binary data output, the GATE output is turned ON.
- (5) The GATE signal output time after the GATE output is turned ON, the GATE output is turned OFF.
- (6) The RESET input is turned ON. During the RESET input minimum time, if the RESET input is turned ON, the measured value is reset.
- (7) The judgment results and binary data are reset.
- (8) After the judgment result and binary data output, the analog output is reset.
- (9) After the judgment result and binary data output, the GATE output is turned ON.
- (10) The GATE signal output time after the GATE output is turned ON, the GATE output is turned OFF.
- (11) The RESET input is turned OFF.

Important

When the setting for non-measurement is "CLAMP", if the sampling value is an abnormal value or an undetermined value *, sampling is not executed. The output value is as follows.

- Hold the clamp value.
- If the previous hold value is not the clamp value, the GATE signal is output.
- The BUSY signal is not turned ON.

*: After the start of measurement, if measurement results are not obtained the number of times required to take the average, the measurement result is not applied.

Bank Switching

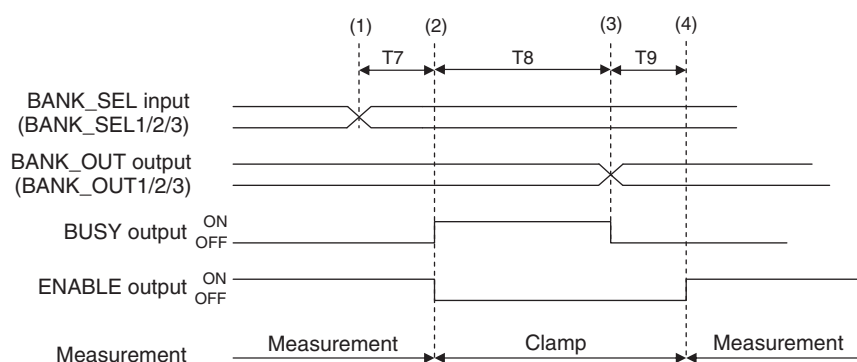

Item		Min.	Max.
T7	Input response time	–	200 ms
T8	Bank switching time	–	100 ms
T9	Measurement start response time	3×T0	Depends on the set conditions

Explanation of operations

- (1) The BANK_SEL signal is switched to the bank number to switch to.
- (2) After the input response time, the measurement stops and the BUSY output is turned ON, then the bank switching operation is started.
- (3) After bank switching ends, the BUSY output is turned OFF and the BANK_OUT output is switched.
- (4) Measurement is restarted and the ENABLE output is turned ON.

LED OFF

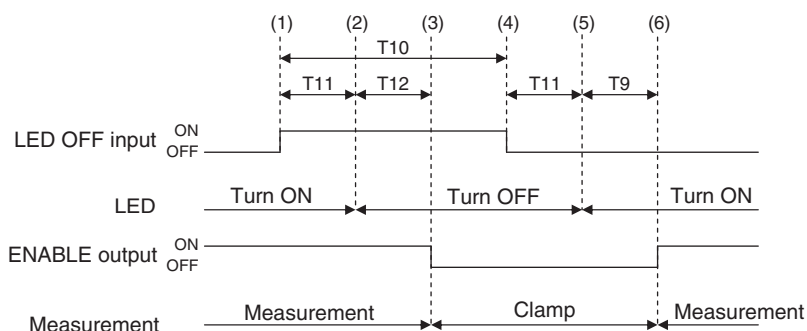

Item		Min.	Max.
T9	Measurement start response time	$3 \times T_0$	Depends on the set conditions
T10	LED OFF input minimum time	100 μ s	–
T11	Time of receiving LED OFF input	–	100 μ s
T12	ENABLE response time after LEDs are turned OFF	–	$2 \times T_0$

Explanation of operations

- (1) The LED OFF input is turned ON.
- (2) After the LED OFF input is turned ON, the LEDs are turned OFF.
- (3) After the LEDs are turned OFF, the ENABLE output is turned OFF.
- (4) The LED OFF input is turned OFF.
- (5) After the LED OFF input is turned OFF, the LEDs are turned ON.
- (6) After the LEDs are lit up, measurement is restarted and the ENABLE output is turned ON.

Zero reset

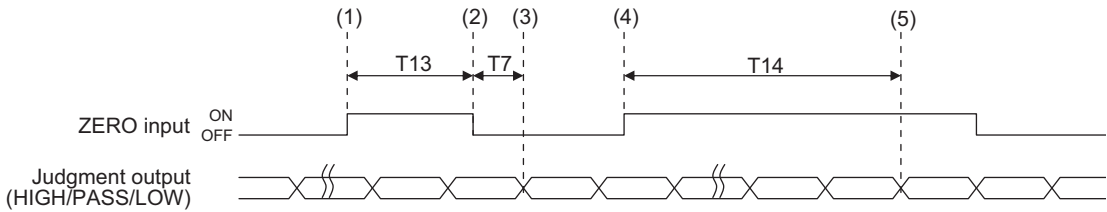

Item		Min.	Max.
T7	Input response time	2 ms+T0	3 ms+T0×2
T13	ZERO input time	50 ms	0.8s
T14	ZERO input cancel time	1 s	—

Explanation of operations

- (1) The ZERO input is turned ON.
- (2) After the ZERO input time, the ZERO input is turned OFF.
- (3) After the ZERO input is turned OFF, the zero reset is executed and the judgment results reflected in the measurement results are output.
- (4) The ZERO input is turned ON.
- (5) After at least the cancel time of ZERO input has passed, the zero reset is cancelled.

Operating Mode Switching

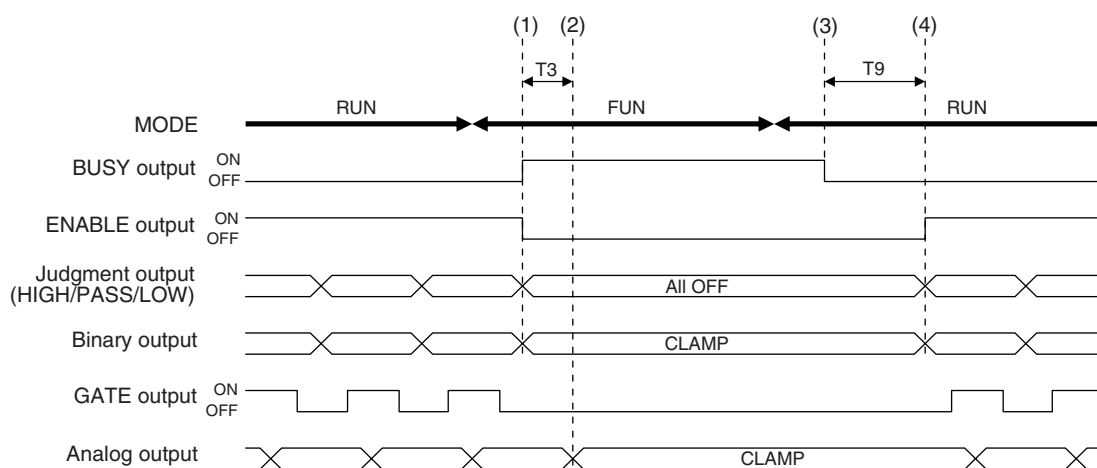

Item		Min.	Max.
T3	Response time of analog output	–	0.1 ms
T9	Measurement start response time	$3 \times T_0$	Depends on the set conditions

Important

In FUN mode, there is no binary output. Immediately after the mode is switched to RUN mode, the clamp value is output until the measured value is applied.

Explanation of operations

- (1) After the mode is switched from RUN to FUN mode, the BUSY output and ENABLE output are turned OFF. The judgment outputs all go OFF and the binary output is output clamped.
- (2) The response time of analog output after the BUSY output is turned ON, the analog output is output clamped.
- (3) After the mode is switched from FUN mode to RUN mode, the BUSY output is turned OFF.
- (4) Measurement is restarted and the ENABLE signal is turned ON, then the measurement results are output.

Binary Output

When the judgment results for all tasks are output at the same time (judgment value mode (When the output target is a judgment value))

The binary output results can be acquired when the GATE output is ON.

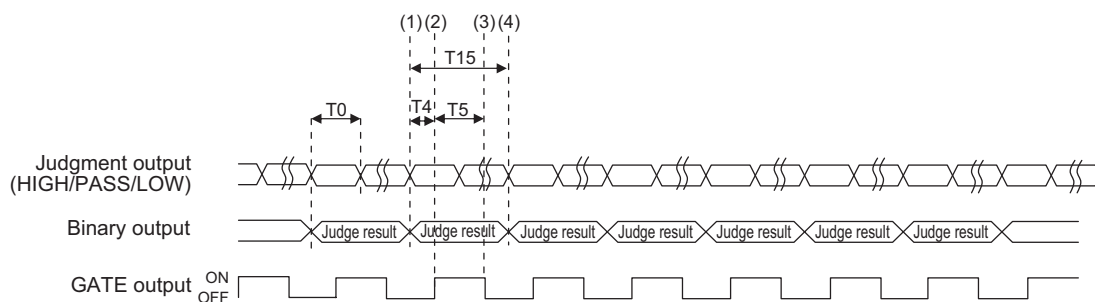

Item		Min.	Max.
T0	Measurement cycle	0.5 ms	Depends on the set conditions
T4	GATE signal rise time	–	0.2 ms
T5	GATE signal output time	Setting value (0.1 to 100.0 ms)	Setting value (0.1 to 100.0 ms)
T15	Binary output update cycle	T0×Update cycle	T0×Update cycle

Explanation of operations

- (1) The TASK2, 3 and 4 judgment results (HIGH/PASS/LOW) are output.
- (2) After the judgment result output, the GATE output is turned ON.
- (3) The GATE signal output time after the GATE output is turned ON, the GATE output is turned OFF.
- (4) After the binary output update cycle, the TASK2, 3 and 4 judgment results are updated.

Task Measurement Result Output

The following two output methods can be selected from.

- Measured value 1 mode (When measured values for multiple tasks are output consecutively)
The preset tasks are output in order for each of a certain cycle.
- Measured value 2 mode (When measured values for multiple tasks are output by BINARY_SEL input)
The tasks to output with binary output are selected with external input and the measurement data for those tasks is output.

Measured value 1 mode (When measured values for multiple tasks are output consecutively)

The binary output results can be acquired when the GATE output is ON.

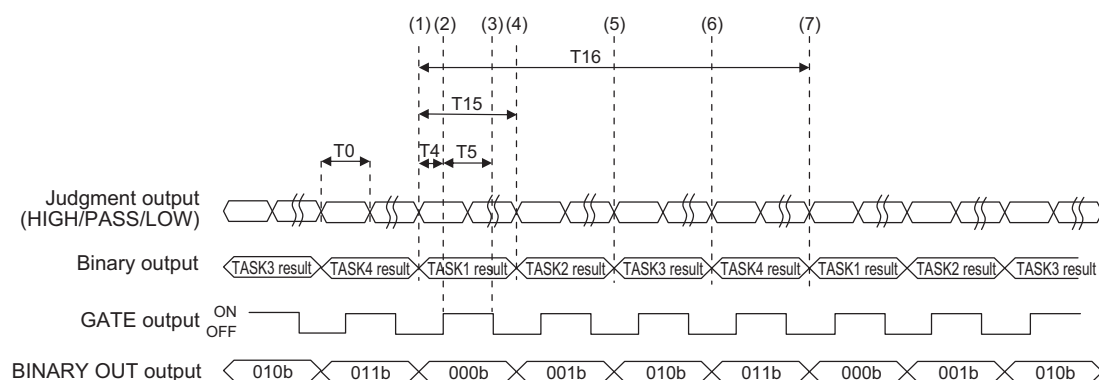

Item		Min.	Max.
T0	Measurement cycle	0.5 ms	Depends on the set conditions
T4	GATE signal rise time	–	0.2 ms
T5	GATE signal output time	Setting value (0.1 to 100.0 ms)	Setting value (0.1 to 100.0 ms)
T15	Binary output update cycle	T0×Update cycle	T0×Update cycle
T16	Binary output update cycle 2	T0×Update cycle×number of tasks output	T0×Update cycle×number of tasks output

Explanation of operations (When the results for all tasks are output)

- (1) The TASK1 results are output (judgment output and binary output).
- (2) After the judgment result and binary data output, the GATE output is turned ON.
- (3) The GATE signal output time after the GATE output is turned ON, the GATE output is turned OFF.
- (4) After the binary output update cycle, the TASK2 results are output (judgment output and binary output).
- (5) After the binary output update cycle, the TASK3 results are output (judgment output and binary output).
- (6) After the binary output update cycle, the TASK4 results are output (judgment output and binary output).
- (7) After binary output update cycle 2, the TASK1 results are output (judgment output and binary output).

Note

Which tasks to output results for can be selected.

Binary output object task selection input p.136

Measured value 2 mode (When measured values for multiple tasks are output by BINARY_SEL input)

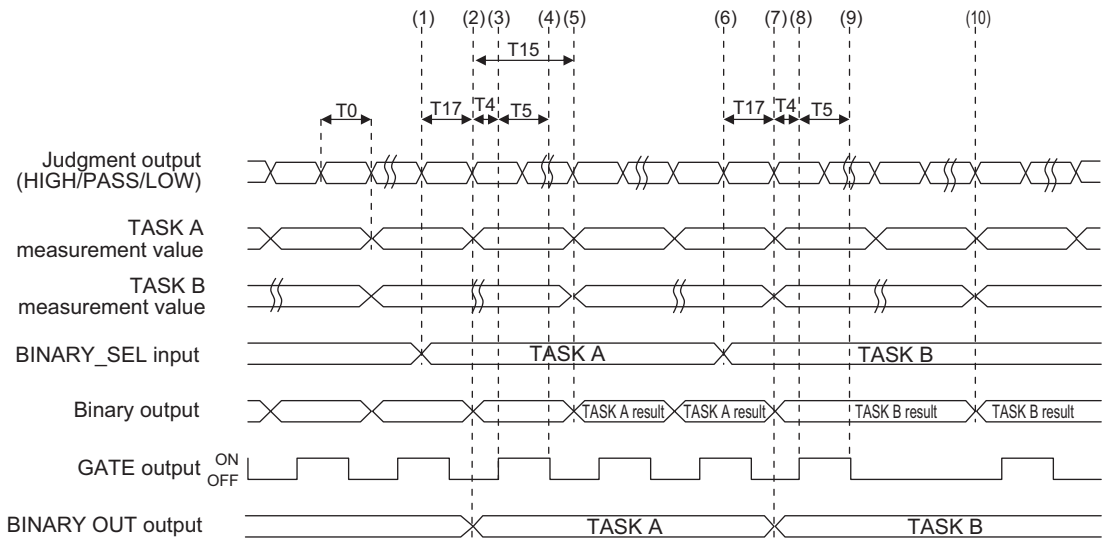

Item		Min.	Max.
T0	Measurement cycle	0.5 ms	Depends on the set conditions
T4	GATE signal rise time	–	0.2 ms
T5	GATE signal output time	Setting value (0.1 to 100.0 ms)	Setting value (0.1 to 100.0 ms)
T15	Binary output update cycle	T0×Update cycle	T0×Update cycle
T17	Response time of input	–	T0

Explanation of operations (When the results for all tasks are output)

- (1) Input the number of the task you want to output to the BINARY_SEL input.
- (2) The results for the selected tasks are output (judgment output and binary output).
- (3) After the judgment result and binary data output, the GATE output is turned ON.
- (4) GATE signal output time after the GATE output is turned ON, the GATE output is turned OFF.
- (5) When the results for the selected tasks are updated, the judgment output and binary output are also updated.
- (6) Input the number of the task you want to output to the BINARY_SEL input.
- (7) The results for the selected tasks are output (judgment output and binary output).
- (8) After the judgment result and binary data output, the GATE output is turned ON.
- (9) GATE signal output time after the GATE output is turned ON, the GATE output is turned OFF.
- (10) When the results for the selected tasks are updated, the judgment output and binary output are also updated.

Internal logging

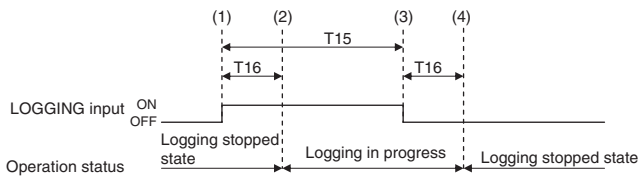

Item		Min.	Max.
T15	LOGGING input minimum time	$3\text{ms}+T_0$	–
T16	Input response time	$2\text{ms}+T_0$	$3\text{ms}+T_0 \times 2$

Explanation of operations

- (1) The LOGGING input is turned ON.
- (2) After the LOGGING input is turned ON, the internal logging is started.
- (3) The LOGGING input is turned OFF.
- (4) After the LOGGING input is turned OFF, the internal logging is ended.

6-2 No-protocol Connection

Outline of No-protocol Communications

A system is possible where no-protocol communications is performed between the displacement sensor and an external device (e.g. PLC) and control from the external device (e.g. PLC) is performed by commands/responses.

Communications with the external device is possible over Ethernet or the RS-232C interface. This control system functions in the RUN mode. Communications is not possible in the FUN mode. Also, when a system error occurs, commands from the external device are accepted, though setting commands are not executed.

● Command/response system

With no-protocol communications, a control command is sent to the displacement sensor from the external device (e.g. PLC) and the response is sent from the displacement sensor is received by the external device (e.g. PLC). By this, the measured value is acquired from the displacement value, and bank switch and various other controls are performed.

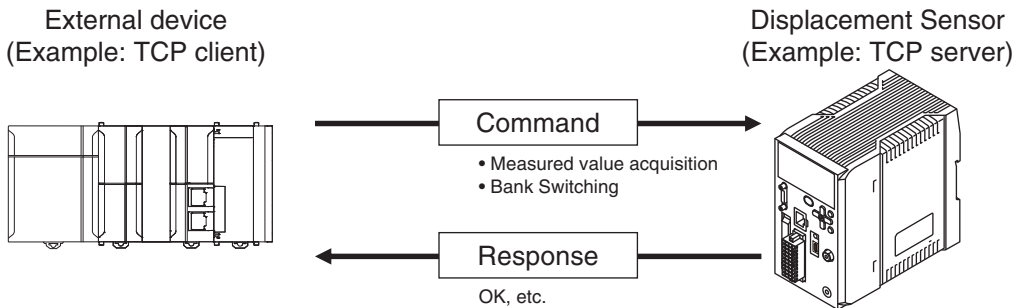

In actual terms, an ASCII character command (e.g. "MS" for acquiring the measured value) is issued from the external device (e.g. PLC). The displacement sensor returns responses such as "OK", "NG" or a value.

● Serial data output method after application of measured value

When hold is set, immediately after the measured value has been applied, the measured value data from the displacement sensor is output automatically to the output device (e.g. PLC).

This enables the measurement value data for all tasks to be easily handed over to an external device (e.g. PLC).

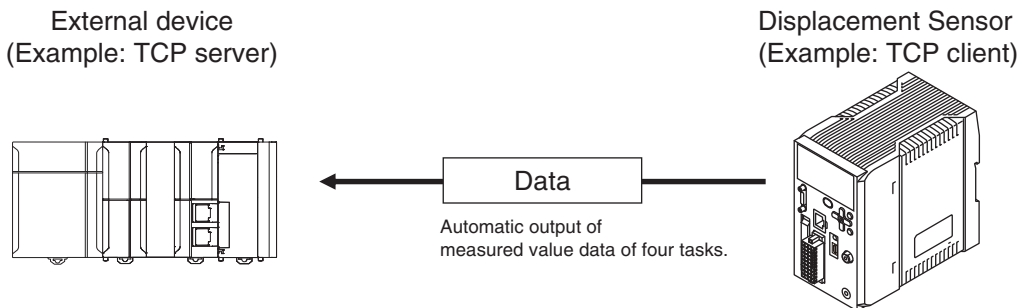

Data can be output with Ethernet or with RS-232C. Measured value data can be sent to an external device (e.g. PLC) serially (continuously) in ASCII format or binary format. External device

There is no handshaking for whether or not an external device (e.g. PLC) can receive data.

Setting Up No-protocol Communications

Setting Network Settings in the Sensor

This section describes how to set the network settings in the Displacement Sensor.

- ▶ **Explorer pane** : [Device group] | Sensor name | [System] | [System data] (Double-click)
- **Edit Pane** : [Ethernet communication settings] icon (🌐) | [Ethernet settings]

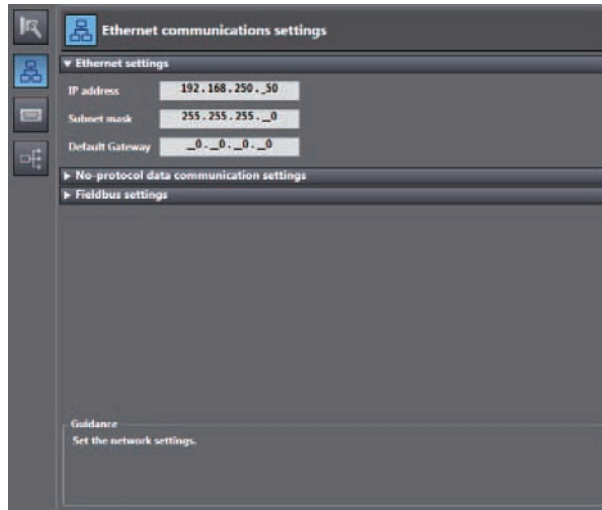

The following items can be set.

Item	Description	Setting range
IP address	Set the IP address of the Displacement Sensor.	a.b.c.d a: 1 to 223, b: 0 to 255, c: 0 to 255, d: to 254 (Default: 192.168.255.50)
Subnet mask	Set the subnet mask.	0.0.0.0 to 255.255.255.255 (Default: 255.255.255.0)
Default Gateway	Sets the default gateway.	0.0.0.0 to 255.255.255.255 (Default: 0.0.0.0)

Initial Settings for No-protocol Communications

You must set the communications method, destination IP address, and I/O port number of the destination external device to perform no-protocol communications.

- **Explorer pane** : [Device group] | Sensor name | [System] | [System data] (Double-click)
 → **Edit Pane** : [Ethernet communication settings] icon () |
 [No-Protocol data communication setting]

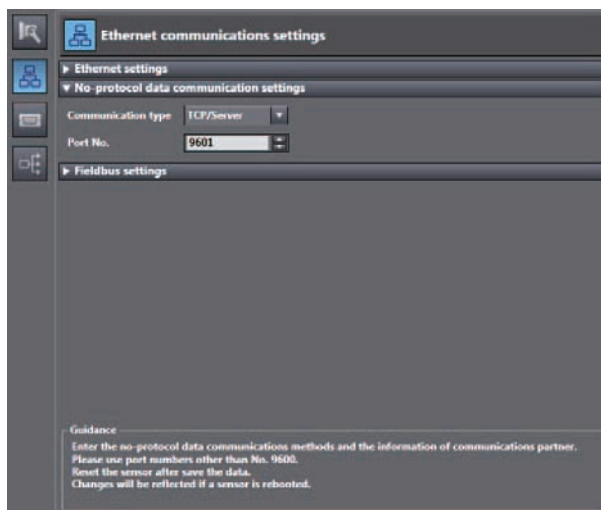

Item	Description	Setting range
Communication type	Select the communications method.	<ul style="list-style-type: none"> • OFF • TCP server • TCP client • UDP (Default: TCP server)
Port No. In	Sets the ZW port number when the UDP or TCP server is selected.	0 to 65,535 (Default: 9601) <ul style="list-style-type: none"> • The following port number is reserved and cannot be used: 9600
IP address	Set the IP address of the external device at the connection destination when the UDP or TCP client is selected. Set it in the form a.b.c.d. <div style="border: 1px solid black; padding: 2px; margin: 5px 0;">Note</div> If you connect an external OMRON CS/CJ-series PLC to Ethernet, the following default IP address is assigned to the PLC. <ul style="list-style-type: none"> • IP address: 192.168.250.node_address 	a: 1 to 223, b: 0 to 255, c: 0 to 255, d: to 254 (Default: 192.168.250.100)
Port No. Out	Set the I/O port number of the external device at the connection destination when the UDP or TCP client is selected. Set the value to between 0 and 65,535.	0 to 65,535 Default: 9,600 (Default: 9,601)

Important

If set Communication type to TCP client, please start a ZW after make sure the external device to be TCP server is ready to communicate. In addition, the communication is interrupted for reasons such as the ethernet cable is disconnected, please restart the ZW If you can not reconnect.

Note

The initial setting for No-protocol Communications can also be set by the operating keys on the Sensor Controller.



Initial Settings for No-protocol Communications p.277

Setting Communications Specifications (RS-232C Communications)

Setting RS-232C communications on the sensor body

Set RS-232C communications on the displacement sensor body.

- ▶ **Explorer pane** : [Device Group] | [(Sensor Name)] | [System] | [System Data] (double-click)
- **Edit pane** : [RS-232C Communications Settings] icon 

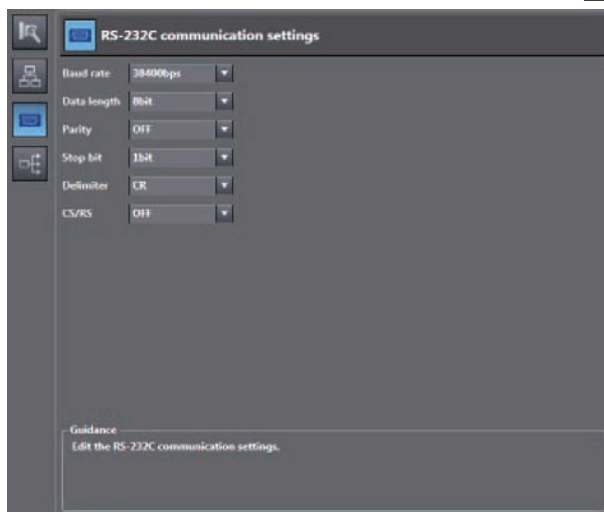

Item	Description	Range
Baud rate	Sets the data transfer speed.	9600bps, 19200bps, 38400bps (default value), 57600bps, 115200bps
Data length	Sets the data length.	8 bits (default value), 7 bits
Parity	Sets the parity bit (error detection sign).	None (default value), odd, even
Stop bit	Sets the stop bit.	1bit (default), 2bit
Delimiter	Sets the delimiter (data delimiter).	CR (default), LF, CR+LF
CS/RS	Sets the flow control.	OFF(default value)/ON

Note

- With the ZW series, communication cannot be established under the following condition.
Data length: 7-bit and Parity: None
- The RS-232C communication specifications can also be set with key operations on the Sensor Controller.

 9-13 Connecting by No-protocol Communications p.277

Setting for serial data output after application of measured value

When hold is set, the applied measured data can be output automatically.

Data that can be output

The data to be output is measured values applied at the time that the output cause occurs.
The data to be output is fixed to four tasks, TASK1 to TASK4, and can not be set individually.

Timing for outputting data

When hold (peak, bottom, peak-to-peak, average, sampling) is set, the measured value data is output when a measured value is applied for even one of the four tasks. For the trigger method, both timing input from the outside and self-triggering are supported.

Setting the data output destination

Serial data can be output from Ethernet or RS-232C. This section describes the procedure for the setting.

Item	Setting item	Description	Range
Data output settings	Data output destination	Sets the interface for serial data output.	OFF (default value)/Ethernet/RS-232C

► Explorer pane
→ Edit pane

: [System] (double-click)
: [Data output settings] icon ()

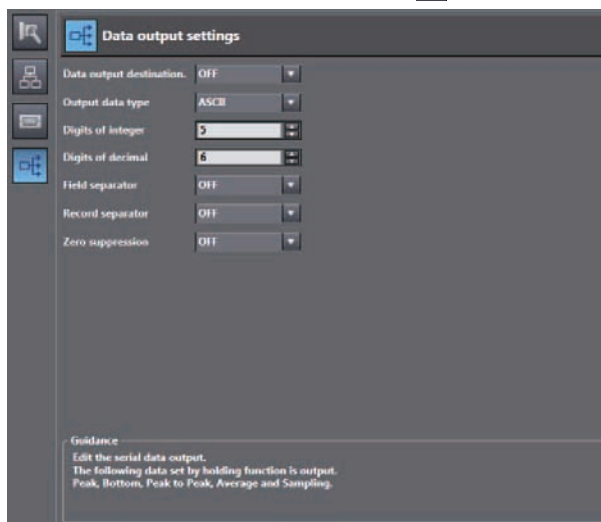

Note

- When the output timing is such that multiple records are buffered, data for up to 10 records is output together.
- When output data is buffered faster than it is output, the outputting can not keep up and an overflow occurs in the ZW. If this happens, "OUT.OVR" appears on the main segment. You can recover from the error display by pressing the ESC/ZERORST key.
- Up to 128 records of output can be buffered.
- Data output destination can also be set by the operating keys on the Sensor Controller.



Setting Serial Data Output p.279

Setting the output format

Item	Setting item	Description	Range
Data output settings	Output data type	Select the output format.	ASCII, Binary (default value: ASCII)
	Digits of integer	Select the number of digits in the integer part.	1 to 5 [digits] (default value: 5 digits)
	Digits of decimal	Select the number of digits in the fractional part.	0 to 6 [digits] (default value: 6 digits)
	Zero suppression	Select whether or not to suppress leading zeros.	ON/OFF (default value: ON)
	Field separator	Select the type of field separator.	OFF, comma, tab, space, CR, LF, CR+LF, semicolon (default value: OFF)
	Record separator	Select the type of record separator.	OFF, comma, tab, space, CR, LF, CR+LF, semicolon (default value: OFF)

► **Explorer pane**
→ **Edit pane**

: **[System] (double-click)**
: **[Data output setting] icon** ()

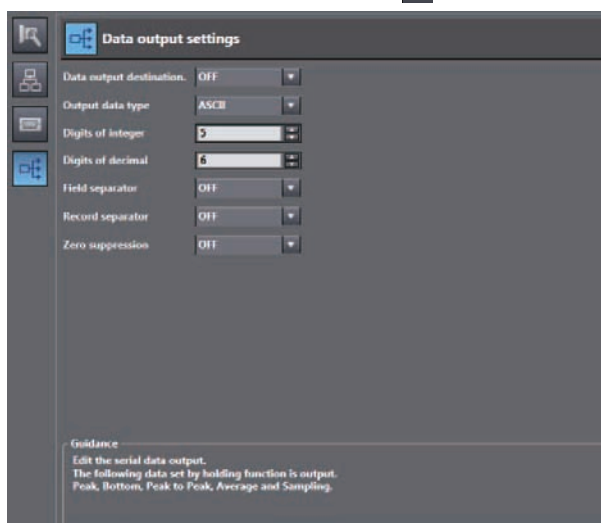

Note

The output format can also be set by the operating keys on the Sensor Controller.

 [Setting Serial Data Output p.279](#)

• When the output format is ASCII

Set the number of digits in the integer section, number of digits in the fraction section, negative number expression, zero suppression, field separator, and record separator items.

• Output Format

TASK1 measured value	,	TASK2 measured value	,	...	TASK4 measured value	CR
----------------------	---	----------------------	---	-----	----------------------	----

Note

The output format, number of digits and the data separator, etc. can be changed if necessary.

Example) Integer digits: "2 digits", fractional digits: "3 digits", zero suppression: "No", field separator: "comma", record separator: "CR"

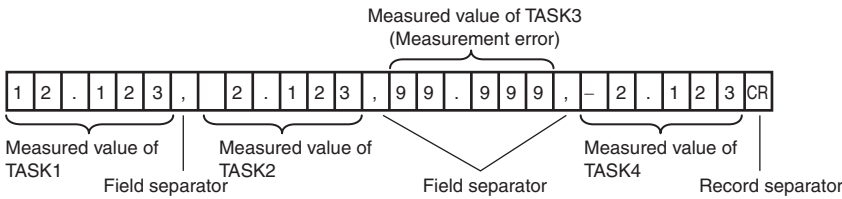

Note

If the measurement result is an abnormal value, the maximum value that can be expressed with the number of integer and fractional digits is output.
 If the measurement result can not be expressed because of the number of digits, the maximum value or minimum value that can be expressed is output.

• When the output format is binary

Set the numeric expression.
 Select whether fixed decimal point or floating decimal point.

• Output Format

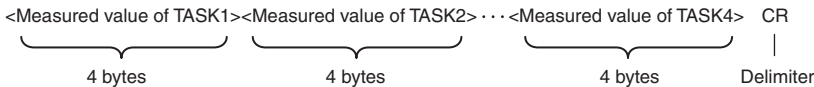

Measurement values expressed in mm are output continuously with 4 bytes per each data item.
 Negative numbers are output in 2's complement format.

(Example) When Task 1 is "37.385762 mm", Task 2 is "40.673256 mm", Task 3 is "Measurement value error", and Task 4 is "39.554658 mm".

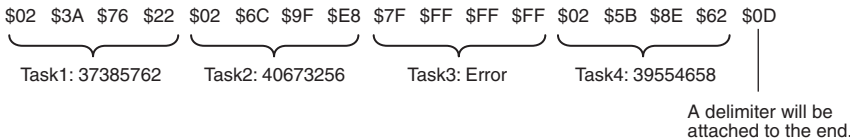

Note

- If the measurement result is an abnormal value, HEX7FFFFFFF is output.
- Unlike ASCII output, binary output has no separators between data such as field separators or record separators, etc.

Command List

This table lists no-protocol communications commands.
The available commands are listed as follows.

Command name	Format	Return value *1	Description	Pages
MS	MS <Task number> <Delimiter>	<Measured value> <Delimiter>	Acquires the current measured value. If the <task number> is omitted, the measured value displayed is acquired. If "4" is set for the <task number>, the measured values for all tasks are obtained.	p.180
JG	JG <Task number> <Delimiter>	<Judgment result> <Delimiter>	Acquires the judgment result of the specified task. If the <task number> is omitted, the result of the task of which the result is currently displayed is acquired. If "4" is set for the <task number>, the judgment results for all tasks are obtained.	p.181
DG	DG <unit number> <Data number> <Delimiter>	<Data> <Delimiter>	Acquires the measurement data and setting data of the processing unit.	p.182
DS	DS <unit number> <Data number> <Measured value> <Delimiter>	OK <Delimiter>	Change the setting data of the processing unit.	p.183
BG	BG <Delimiter>	<Bank number> <Delimiter>	Acquire the current bank number.	p.184
BS	BS <Bank number> <Delimiter>	OK <Delimiter>	Replace the current bank number by the specified bank number.	p.185
ZR	ZR <Task number> <Delimiter>	OK <Delimiter>	Execute a zero reset for the specified task. If the <task number> is omitted, the zero reset is executed for the task of which the result is currently displayed. If "4" is set for the <task number>, this is executed for all tasks.	p.186
ZC	ZC <Task number> <Delimiter>	OK <Delimiter>	Cancel the zero reset of the specified task. If the <task number> is omitted, the zero reset is executed for the task of which the result is currently displayed. If "4" is set for the <task number>, this is executed for all tasks.	p.187
TM	TM <0:OFF/ 1:ON> 0<Delimiter>	OK <Delimiter>	Executes TIMING input. * Calculates OR with the parallel input.	p.188
RT	RT <0:OFF/ 1:ON> 0<Delimiter>	OK <Delimiter>	Executes RESET input. * Calculates OR with the parallel input.	p.188
LD	LD <0: Lit/ 1: Out> 0<Delimiter>	OK <Delimiter>	Turns the logical beam ON/OFF.	p.189
VR	VR <Delimiter>	<Model/Version> <Delimiter>	Acquire the system version information. (Example) ZW-C10 1.100 <Delimiter>	p.189
CA	CA 0 <Delimiter>	OK <Delimiter>	Calibrate the Sensor Head.	p.190
LS	LS <Save intervals> <Number of saves> <Delimiter>	OK <Delimiter>	Start the internal logging of the data.	p.190
LE	LE <Delimiter>	OK <Delimiter>	End the internal logging of the data.	p.191

Command name	Format	Return value *1	Description	Pages
LO	LO <Task number> <First data number> <Output data count> <Delimiter>	<Internal logging data > <Delimiter>	Acquires the internal logging data. If the <task number> is omitted, internal logging data acquisition is executed for the task of which the result is currently displayed. If the <first data number> is omitted, internal logging data acquisition is executed from first data number "0". If the <output data count> is omitted, all internal logging data acquisition is executed.	p.191
LC	LC <Delimiter>	OK <Delimiter>	Clear the internal logging data.	p.192
LI	LI <Delimiter>	<Operation status> <Saved data count> <Delimiter>	Acquire the internal logging information.	p.193
DV	DV <Delimiter>	OK <Delimiter>	Save all bank data and system settings to EEPROM.	p.193
YG	YG <Data number>	<Numerical value data> <Delimiter>	Acquires the system data.	p.194
YS	YS <Data number> <Setting value>	OK <Delimiter>	Sets the system data.	p.195
IG	IG	<IP address> <Delimiter>	Acquires the Ethernet IP address.	p.196
IS	IS <IP address>	OK <Delimiter>	Sets the Ethernet IP address.	p.196
KG	KG <delimiter>	<Subnet mask> <Delimiter>	Acquires the subnet mask.	p.197
KS	KS <subnet mask >	OK <Delimiter>	Sets the subnet mask.	p.197
GG	GG <delimiter>	<Default gateway> <Delimiter>	Acquires the default gateway.	p.198
GS	GS <default gateway>	OK <Delimiter>	Sets the default gateway.	p.198
OG	OG <Socket No.>	<OUT IP address> <Delimiter>	Acquires the OUT IP address of the specified socket number.	p.199
OS	OS <Socket No.> <OUT IP address>	OK <Delimiter>	Sets the OUT IP address of the specified socket number.	p.200
MI	MI	<MAC ADDRESS> <Delimiter>	Acquires the MAC address.	p.201
HS	HS 0 <Delimiter>	<Head serial information> <Delimiter>	Acquires the head serial information.	p.201
RS	RS	OK <Delimiter>	Restarts	p.202

*1: If the command was not successfully processed, "ER <delimiter>" is returned.

Command Format

Measurement command <MS command>

Acquires the current measured value.

* The same can be processed with the M, MEASURE command, which is in a ZS series format.

<Command format>

M	S		*	CR
---	---	--	---	----

↑ Space
↑ Task number

<Response format>

Normal measurement (Task numbers 0 to 3)

(Example) -30.719923mm

		-	3	0	7	1	9	9	2	3	CR
--	--	---	---	---	---	---	---	---	---	---	----

- The return value is right-aligned and 11 characters + delimiter.
- The unit of the measured values is nm.
- Spaces will fill any missing portion from the left.
- If the task number is omitted, the measured value displayed is acquired.

Normal measurement (Task number 4)

(Example) TASK1 -3.071992mm, TASK2 -2.998122mm, TASK3 2.345678mm, and TASK4 2.471249mm

			-	3	0	7	1	9	9	2	,
--	--	--	---	---	---	---	---	---	---	---	---

			-	2	9	9	8	1	2	2	,
--	--	--	---	---	---	---	---	---	---	---	---

				2	3	4	5	6	7	8	,
--	--	--	--	---	---	---	---	---	---	---	---

				2	4	7	1	2	4	9	CR
--	--	--	--	---	---	---	---	---	---	---	----

When measurement is not possible

-	-	-	-	-	-	-	-	-	-	-	CR
---	---	---	---	---	---	---	---	---	---	---	----

When a command was not successfully processed

E	R	CR
---	---	----

<Parameter explanation>

Parameter	Description
Task number	Specifies the number of the task of which the measurement result is to be output. 0: TASK1 1: TASK2 2: TASK3 3: TASK4 4: TASK1 to 4

Judgment result acquisition command <JG command>

Acquires the judgment result of the specified task.

<Command format>

J	G		*	CR
---	---	--	---	----

↑ Space
↑ Task number

<Response format>**Normal processing (Task numbers 0 to 3)**

(Example) When the judgment result is "HIGH"

1	CR
---	----

↑ Judgment result

Normal processing (Task number 4)

(Example) TASK1 judgment result "HIGH", TASK2/TASK3 judgment result "PASS", TASK4 judgment result "LOW"

1	,	0	,	0	,	2	CR
---	---	---	---	---	---	---	----

When a command was not successfully processed

E	R	CR
---	---	----

<Parameter explanation>

Parameter	Description
Task number	Specifies the number of the task of which the judgment result is to be output. 0: TASK1 1: TASK2 2: TASK3 3: TASK4 4: TASK1 to 4
Judgment result	Displays the judgment result. PASS: 0 HIGH: 1 LOW: 2 ERROR: 3

Processing unit data acquisition command <DG command>

Acquires the measurement data and setting data of the processing unit.

<Command format>

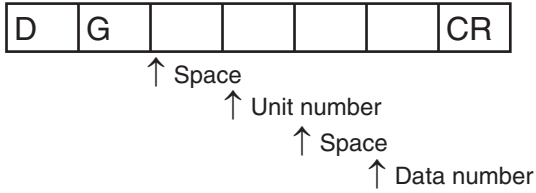

<Response format>

Normal processing

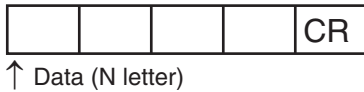

When a command was not successfully processed



<Parameter explanation>

Parameter	Description
Unit number	Specifies the unit number (0 to 255) to be acquired.
Data number	Specifies the data number (0 to 255) to be acquired.

Important

For unit numbers and data numbers, refer to "10-3 Processing Item Data List" (p.308).

Processing unit data setting command <DS command>

Change the setting data of the processing unit.

<Command format>

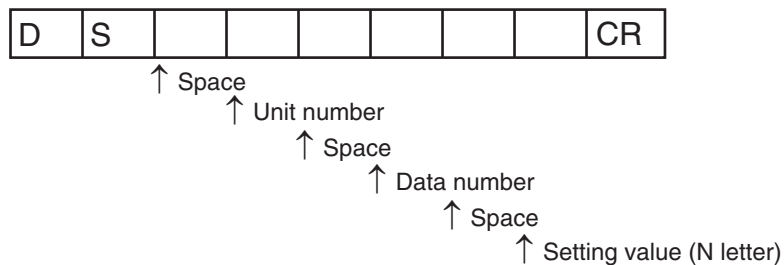

<Response format>

Normal processing

O	K	CR
---	---	----

When a command was not successfully processed

E	R	CR
---	---	----

<Parameter explanation>

Parameter	Description
Unit number	Specifies the unit number (0 to 255) to be acquired.
Data number	Specifies the data number (0 to 255) to be acquired.
Setting value	This is the setting value of the specified data.

Important

For unit numbers and data numbers, refer to "10-3 Processing Item Data List" (p.308).

Current bank data acquisition command <BG command>

Acquire the current bank number.

<Command format>

B	G	CR
---	---	----

<Response format>

Normal processing

	CR
--	----

↑ Bank number

When a command was not successfully processed

E	R	CR
---	---	----

<Parameter explanation>

Parameter	Description
Bank number	Displays the current bank number. 0: BANK1 1: BANK2 2: BANK3 3: BANK4 4: BANK5 5: BANK6 6: BANK7 7: BANK8

Current bank data setting command <BS command>

Replace the current bank number by the specified bank number.

<Command format>

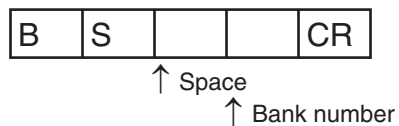

<Response format>

Normal processing



When a command was not successfully processed



<Parameter explanation>

Parameter	Description
Bank number	Specifies the bank number to switch to. 0: BANK1 1: BANK2 2: BANK3 3: BANK4 4: BANK5 5: BANK6 6: BANK7 7: BANK8

Zero reset execution command <ZR command>

Execute a zero reset for the specified task.

<Command format>

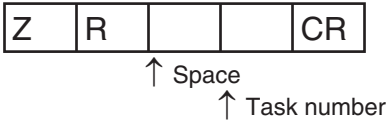

<Response format>

Normal processing



- If the task number is omitted, the zero reset is executed for the task of which the result is currently displayed.
- If "4" is set for the task number, the zero reset is executed for all tasks.

When a command was not successfully processed



<Parameter explanation>

Parameter	Description
Task number	Specifies the number of the task for which the zero reset is to be executed. 0: TASK1 1: TASK2 2: TASK3 3: TASK4 4: TASK1 to 4

Zero reset cancel command <ZC command>

Cancel the zero reset of the specified task.

<Command format>

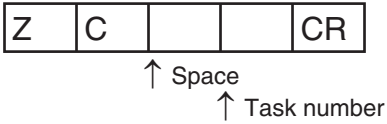

<Response format>

Normal processing



- If the task number is omitted, the zero reset is canceled for the task of which the result is currently displayed.
- If "4" is set for the task number, the zero reset is canceled for all tasks.

When a command was not successfully processed



<Parameter explanation>

Parameter	Description
Task number	Specifies the number of the task for which the zero reset is to be cancelled. 0: TASK1 1: TASK2 2: TASK3 3: TASK4 4: TASK1 to 4

TIMING input command <TM command>

Executes TIMING input.

<Command format>

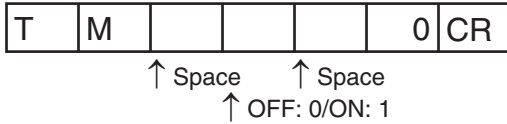

<Response format>

Normal processing



When a command was not successfully processed



RESET input command <RT command>

Executes RESET input.

<Command format>

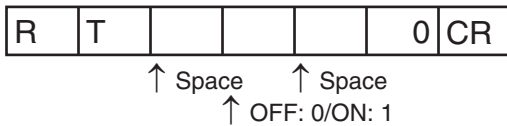

<Response format>

Normal processing



When a command was not successfully processed

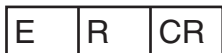

White LED OFF input command <LD command>

Turns the logical beam ON/OFF.

<Command format>

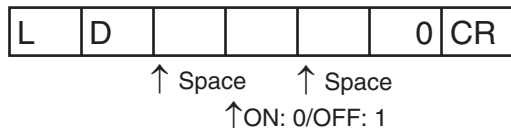

<Response format>

Normal processing



When a command was not successfully processed



Version information acquisition command <VR command>

Acquire the system version information.

<Command format>



<Response format>

Normal processing

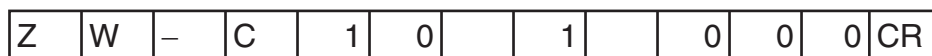

When a command was not successfully processed



Sensor head calibration command <CA command>

Calibrate the Sensor Head.

<Command format>

C	A		0	CR
---	---	--	---	----

↑ Space

<Response format>

Normal processing

O	K	CR
---	---	----

When a command was not successfully processed

E	R	CR
---	---	----

Internal logging start command <LS command>

Start the internal logging of the data.

<Command format>

L	S					CR
---	---	--	--	--	--	----

↑ Space
↑ Save intervals
↑ Space
↑ Save count

<Response format>

Normal processing

O	K	CR
---	---	----

When a command was not successfully processed

E	R	CR
---	---	----

<Parameter explanation>

Parameter	Description
Save intervals	Sets the intervals(0 to 1000) to be internally logged. If "1" is set , all measured data is stored, and "2" is set, one measured data is stored every two measurement. If "0" is set, only the applied measured data is stored when hold is set.
Save count	Sets the maximum data count (1 to 12,800) to be internally logged. The internal logging process ends when the number of internal logging data reaches the maximum.

Internal logging end command <LE command>

End the internal logging of the data.

<Command format>

L	E	CR
---	---	----

<Response format>

Normal processing

O	K	CR
---	---	----

When a command was not successfully processed/When internal logging is not started

E	R	CR
---	---	----

- The internal logging process ends without sending LE command when the number of internal logging data reaches the maximum.

Internal logging data acquisition command <LO command>

Acquires the internal logging data.

<Command format>

L	O							CR
---	---	--	--	--	--	--	--	----

↑ Space ↑ Space ↑ Space ↑ Output data count
 ↑ Task number ↑ First data number

- If the <task number> is omitted, internal logging data acquisition is executed for the task of which the result is currently displayed.
- If the <first data number> is omitted, internal logging data acquisition is executed from first data number "0".
- If the <output data count> is omitted, all internal logging data acquisition is executed.

<Response format>

Normal processing

The internal logging data is output.

(Example) TASK1 -3.071992mm, TASK2 -2.998122mm, TASK3 2.345678mm, and TASK4 2.471249mm

			-	3	0	7	1	9	9	2	,
			-	2	9	9	8	1	2	2	,
				2	3	4	5	6	7	8	,
				2	4	7	1	2	4	9	CR

- The character format is ASCII.
- The return value is right-aligned and 11 characters + delimiter.
- The unit of the measured values is nm.
- Spaces will fill any missing portion from the left.

When a command was not successfully processed/When internal logging is not stopped

E	R	CR
---	---	----

<Parameter explanation>

Parameter	Description
Task number	Sets the task number under which to obtain internal log data. 0: TASK1 1: TASK2 2: TASK3 3: TASK4
First data number	Sets the first logging data number (0 to 12800) that is acquired from beginning. Beginning data number is "0".
Output data count	Sets the logging data count (0 to 12800) that is acquired. If stored internal logging data count is lower than setting, all logging data is acquired. If nothing is stored, command response is ER.

Internal logging data clear command <LC command>

Clear the internal logging data.

<Command format>

L	C	CR
---	---	----

<Response format>

Normal processing

O	K	CR
---	---	----

When a command was not successfully processed/When internal logging is not stopped

E	R	CR
---	---	----

- If internal logging is started without clearing logging data, data is saved end of last logging data.
- When ZW internal memory size is not enough, internal logging is automatically ended. Overwrite is not executed.

Internal logging data information acquisition command <LI command>

Acquire the internal logging information.

<Command format>

L	I	CR
---	---	----

<Response format>**Normal processing**

			CR
--	--	--	----

↑ Operation status

↑ Space

↑ Saved data count

When a command was not successfully processed

E	R	CR
---	---	----

<Parameter explanation>

Parameter	Description
Operation status	Displays the internal logging process status. 0: Internal logging stopped state 1: Internal logging in progress
Saved data count	Displays the number of saved logging data (0 and more).

Data save command <DV command>

Save all bank data and system settings to EEPROM.

<Command format>

D	V	CR
---	---	----

<Response format>**Normal processing**

O	K	CR
---	---	----

When a command was not successfully processed

E	R	CR
---	---	----

System data acquisition <YG command>

Acquires the system data.

<Command format>

Y	G			CR
---	---	--	--	----

↑ Space
↑ Data number

<Response format>

Normal processing

			CR
--	--	--	----

↑ Data (N letter)
↑ Space

When a command was not successfully processed

E	R	CR
---	---	----

<Parameter explanation>

Parameter	Description
Data number	Specifies the data number (0 to 255) to be acquired.

Note

For data numbers, refer to "10-4 System data list."

System data setting <YS command>

Sets the system data.

<Command format>

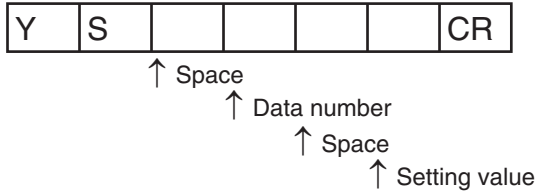

<Response format>

Normal processing

O	K	CR
---	---	----

When a command was not successfully processed

E	R	CR
---	---	----

<Parameter explanation>

Parameter	Description
Data number	Specifies the data number to be acquired.
Setting value	This is the setting value of the specified data.

Note

For data numbers, refer to "10-4 System data list."

IP address acquisition <IG command>

Acquires the IP address.

<Command format>

I	G	CR
---	---	----

<Response format>

Normal processing

(Example) When the IP address of the ZW is 192.168.250.50

1	9	2	.	1	6	8	.	2	5	0	.	5	0	CR
---	---	---	---	---	---	---	---	---	---	---	---	---	---	----

When a command was not successfully processed

E	R	CR
---	---	----

IP address setting <IS command>

Sets the IP address.

<Command format>

I	S		1	9	2	.	1	6	8	.	2	5	0	.	5	0	CR
---	---	--	---	---	---	---	---	---	---	---	---	---	---	---	---	---	----

↑ Space

<Response format>

Normal processing

O	K	CR
---	---	----

When a command was not successfully processed

E	R	CR
---	---	----

Subnet mask acquisition <KG command>

Acquires the subnet mask.

<Command format>

K	G	CR
---	---	----

<Response format>

Normal processing

(Example) When the ZW subnet mask is 255.255.255.0

2	5	5	.	2	5	5	.	2	5	5	.	0	CR
---	---	---	---	---	---	---	---	---	---	---	---	---	----

When a command was not successfully processed

E	R	CR
---	---	----

Subnet mask setting <KS command>

Sets the subnet mask.

<Command format>

(Example) When setting subnet mask 255.255.255.0 for the ZW

K	S		2	5	5	.	2	5	5	.	2	5	5	.	0	CR
---	---	--	---	---	---	---	---	---	---	---	---	---	---	---	---	----

↑ Space

<Response format>

Normal processing

O	K	CR
---	---	----

When a command was not successfully processed

E	R	CR
---	---	----

Default gateway acquisition <GG command>

Acquires the default gateway.

<Command format>

G	G	CR
---	---	----

<Response format>

Normal processing

(Example) When the ZW default gateway is 0.0.0.0

0	.	0	.	0	.	0	CR
---	---	---	---	---	---	---	----

When a command was not successfully processed

E	R	CR
---	---	----

Default gateway setting <GS command>

Sets the default gateway.

<Command format>

(Example) When setting the default gateway 0.0.0.0 for the ZW

G	S		0	.	0	.	0	.	0	CR
---	---	--	---	---	---	---	---	---	---	----

↑ Space

<Response format>

Normal processing

O	K	CR
---	---	----

When a command was not successfully processed

E	R	CR
---	---	----

OUT IP address acquisition of the specified socket number <OG command>

Acquires the OUT IP address.

<Command format>

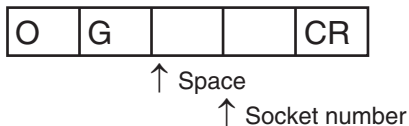

<Response format>

Normal processing

(Example) When the OUT IP address of the ZW is 192.168.250.100

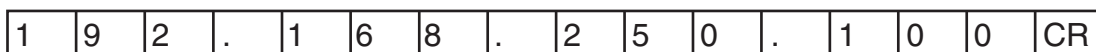

When a command was not successfully processed



<Parameter explanation>

Parameter	Description
Socket number	Specifies the socket number of which the serial data is to be output. 1: Socket 1 (fixed at 192.168.250.100) 2: Socket 2 3: Socket 3 (fixed at 192.168.250.100) 4: Socket 4 (fixed at 192.168.250.100) (*) Sockets 3 and 4 are not used for serial data output.

OUT IP address setting of the specified socket number <OS command>

Sets the OUT IP address.

<Command format>

O	S				1	9	2	.	1	6	8	.	2	5	0	.	1	0	0	CR

↑ Space ↑ Space
 ↑ Socket number

<Response format>

Normal processing

O	K	CR
---	---	----

When a command was not successfully processed

E	R	CR
---	---	----

<Parameter explanation>

Parameter	Description
Socket number	Specifies the socket number of which the serial data is to be output. 1: Socket 1 (fixed at 192.168.250.100) 2: Socket 2 3: Socket 3 (fixed at 192.168.250.100) 4: Socket 4 (fixed at 192.168.250.100) (*1) Sockets 3 and 4 are not used for serial data output. (*2) Sockets 1, 3 and 4 are fixed and cannot be set by this command. Note, however, that OK is returned as the response.

MAC address acquisition <MI command>

Acquires the MAC address.

<Command format>

M	I	CR
---	---	----

<Response format>

(Example) When the MAC address of the ZW is 00.00.0A.75.00.00

Normal processing

0	0	.	0	0	.	0	A	.	7	5	.	0	0	.	0	0	CR
---	---	---	---	---	---	---	---	---	---	---	---	---	---	---	---	---	----

When a command was not successfully processed

E	R	CR
---	---	----

Head serial information acquisition <HS command>

Acquires the head serial information.

<Command format>

H	S		0	CR
---	---	--	---	----

↑ Space

<Response format>**Normal processing**

(Example) When the head serial information is 1234567

1	2	3	4	5	6	7	CR
---	---	---	---	---	---	---	----

When a command was not successfully processed

E	R	CR
---	---	----

Restart <RS command>

Restarts the Sensor Controller

<Command format>

R	S	CR
---	---	----

<Response format>

Normal processing

O	K	CR
---	---	----

When a command was not successfully processed

E	R	CR
---	---	----

Offline Settings

7-1 Performing Settings Offline.....	204
7-2 Starting a Project in Offline Mode.....	205
7-3 Changing between Online and Offline	206

7-1 Performing Settings Offline

The personal computer tools set enables the user to perform settings offline without connecting an actual sensor.

Parameters set offline can be saved as project data just like parameters set online, and conditions set offline can be transferred to the sensor as desired.

The following functions are disabled during offline setting.

Item			Reference (Pages)	
Main screen	Online		Internal logging	p.125
			Trend monitor	p.116
	Tool		Sensor setup	p.112 p.129 p.304
Bank data edit pane	Monitor		Measurement value monitor	p.54
			Line bright monitor	
			LED light	
			I/O input	
	Task	Filer	Scaling (automatic setting)	p.84
I/O	Analog output	Analog output correction	p.141	

7-2 Starting a Project in Offline Mode

To start a project in Offline Mode, select [Enter the type] on the Select Sensor Dialog Box after you create a project, then select the sensor type and version.

You cannot change the sensor type and version after you select them.

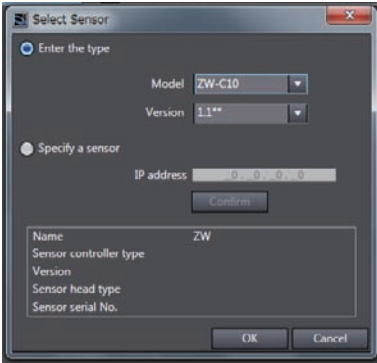

7-3 Changing between Online and Offline

Before you go offline, save all settings and parameter changes to the Sensor's internal memory. Saving your project does not save the data in the Sensor.

You can use the following two methods to change between offline and online.

► **Explorer pane** : **Right-click the Sensor model** | **[Offline/Disconnect]** or **[Online/Connect]**

► **Explorer pane** : **[Device group] | [(Sensor model)] (Double-click)**
→ **Edit pane** : **[Online] Icon** | **[Sensor connection] | [Connect] or [Disconnect]**

1 To go offline, click **[Disconnect]**. To go online, click **[Connect]**.

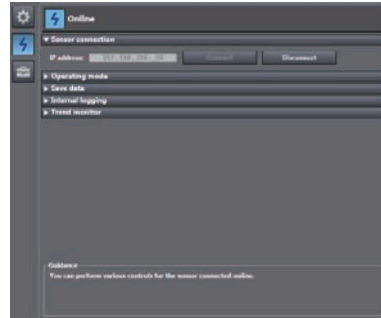

2 When you click **[Connect]**, the **Connect to Sensor Dialog Box** is displayed.

3 When you click **[Connect]**, you must **synchronize the data between the Sensor and the project.**

Follow the guidance and synchronize the data.

Note



Saving the Bank/System Settings p.108, p.255
Saving a project p.66

Troubleshooting

8-1 Error Messages	208
8-2 Troubleshooting	210

8-1 Error Messages

Errors for Ethernet Connection

The error log for the following errors that occur in Ethernet communications can be checked on the digital displays.

Error Code	Name	Description	Cause	Remedy
03D0 Hex ALARM	Ethernet communication parameter error	An invalid IP address is set.	Invalid IP address setting	Change to the correct IP address.
03D3 Hex	Ethernet link not detected	The Ethernet link cannot be detected.	Link with switching hub not detected	Inspect the following items: <ul style="list-style-type: none">• Are cables connected?• Are cables disconnected or loose?• Is there a lot of noise?

Note When error marked by **ALARM** occur, the ALARM output of parallel I/O turns ON, and "SYSERR" and error code are displayed on the main and sub-displays, respectively.

If an error code other than the one listed above is displayed, the displacement sensor may be broken. Please contact an OMRON branch or sales office.

Errors Common to All Communication States

These errors occur in common regardless of communication state. When these errors occur, the ALARM output of parallel I/O turns ON, and "SYSERR" and error code "CODE.XX" are displayed on the main and sub-displays, respectively.

Error Code	Name	Description	Cause	Remedy
02	Linearity correction data error	The linearity correction data is corrupted.	Calibration ROM damage	Check to make sure that the Calibration ROM is correctly inserted. If correctly inserted, the Calibration ROM or displacement sensor may be broken. Please contact an OMRON branch or sales office. ^(*)
03	Linearity correction data read error	Reading of the linearity correction data was not executed correctly.	Calibration ROM not inserted	
07	System setting error	The system settings saved to the Sensor Controller are corrupt.	The displacement sensor power was turned OFF during saving/loading of system settings.	After holding down the Mode switching key, press the ZERO/SET key to clear the system settings and the bank data, then resume the starting process.
08	Bank data error	The bank data saved to the Sensor Controller is corrupt.	The displacement sensor power was turned OFF during saving/loading of bank data.	
11	Firmware update error	Failed to update the firmware by WarpEngineZW.	WarpEngineZW was interrupted during an update.	Do not operate WarpEngineZW during an update. If this error occurs, turn the displacement sensor ON again and retry the update.
25	Ethernet communication parameter error	An invalid IP address is set.	Invalid IP address setting	Change to the correct IP address.

If an error code other than the one listed above is displayed, the displacement sensor may be broken. Please contact an OMRON branch or sales office.

- *1: As a provisional measure, the measurement can be resumed using the data of the previously read Calibration ROM.
- <Operation method>
 - With error code 3 displayed on the sub-display, hold down the Mode switching key, then when [OK/CAN] is displayed, press the ZERO/SET key.
 - <Cautions>
 - When using this method, always check the serial number of the previously read Calibration ROM in "controller information," then check that it matches the Sensor Head side serial number. Measurement will not be correct unless they match.
 - When restarting the main unit, perform the same operations again.
- This operation is disabled for a displacement sensor into which no Calibration ROM has ever been inserted and started up.

8-2 Troubleshooting

This section describes how to temporarily remedy hardware-related trouble.
Check the items below before sending the hardware for repair.

Error type	Phenomenon	Cause	Countermeasure	Pages
Startup error	Device restarts during operation.	The power supply device is not connected correctly.	Check if the power supply device conforms to the power supply specifications.	p.4
		The power supply capacity is insufficient.		
Display error	The main display remains on "- - - - -."	The target to measure is not in the measuring range.	Set the target to measure in the measuring range.	p.27 p.284
		TIMING input is not ON.	Turn the TIMING input ON.	p.40
		The trigger level is not appropriately set for self-trigger.	Set the self-trigger level to an appropriate value.	p.97 p.245
	Refer to the "The measured values fluctuate." and "The logical beam does not come out of the Sensor Head." items below.		-	
	The main display becomes "SYSERR."	A system error has occurred.	Identify the cause of the error based on the error code displayed on the sub-display and take an appropriate action.	p.209
Measurement error	Abnormal distances are displayed in areas clearly outside the measuring range.	Such phenomena are characteristic of the sensor.	<ul style="list-style-type: none"> • Check the target to measure and the measuring distance. • Lowering the exposure time setting value may improve the situation. 	p.75 p.230
		The measured values fluctuate.	The average count is not set correctly.	Set the average count correctly.
		The target to measure or the Sensor Head is vibrating.	Implement a vibration-control countermeasure.	-
		The fiber cable end surface or the lens surface of the Sensor Head is dirty.	Clean the surface.	p.7 p.34
		The connection between the Sensor Head and the Sensor Controller or the connection with the extension fiber cable is not normal.	Check the fiber cable connections.	p.34
		The fiber cable is disconnected.	Replace the fiber cable.	-
		The Sensor Head lens is broken.	The Sensor Head needs to be repaired. Please contact an OMRON branch or sales office. For Sensor Head repair, return as a set with the Calibration ROM.	-
		Water and/or oil droplets are attached.	Perform air purging and so forth to remove the droplets.	-

Error type	Phenomenon	Cause	Countermeasure	Pages
Measurement error	The measured values fluctuate.	Intense ambient light is present.	<ul style="list-style-type: none"> Shield the ambient light. Increase the background removal level. 	Smart Monitor ZW Operation Manual
		Mutual interference is occurring.	Check the Sensor Head installation position.	p.29
	The measured values fluctuate gradually.	The operating ambient temperature is fluctuating.	<ul style="list-style-type: none"> Maintain a certain operating ambient temperature. Execute zero reset periodically using the standard object. 	p.61 p.134
		The warm-up time is inadequate.	Wait 30 minutes after switching ON the power before using.	p.6
	The measured values differ from the intended values.	The target to measure is inclined or the position is offset.	Place the target to measure correctly in the measuring range.	p.27
		The scaling has not been done correctly.	Check the scaling setting.	p.83 p.240
		The zero reset value is not correct.	Set the zero reset correctly.	p.101 p.248
		The Sensor Head has not been calibrated correctly.	Recalibrate the Sensor Head.	p.38
	Measured values are output even though there is no target.	The fiber cable end surface or the lens surface of the Sensor Head is dirty.	Clean the surface.	p.34
		The connection between the Sensor Head and the Sensor Controller or the connection with the extension fiber cable is not normal.	Check the fiber cable connections.	p.34
		Intense ambient light is present.	<ul style="list-style-type: none"> Shield the ambient light. Increase the background removal level. 	Smart Monitor ZW Operation Manual
		Mutual interference is occurring.	Check the Sensor Head installation position.	p.29
	Measurement values are output even though the sensor head's fiber cable is not connected to the Sensor Controller.	The Sensor Controller side fiber connector is dirty.	Clean the surface.	p.34
	The logical beam is not emitted from the Sensor Head.	The connection between the Sensor Head and the Sensor Controller or the connection with the extension fiber cable is not normal.	Check the fiber cable connections.	p.34
The fiber cable end surface or the lens surface of the Sensor Head is dirty.		Clean the surface.	p.34	
The fiber cable is disconnected.		Replace the fiber cable.	p.34	
The LED OFF input line is short-circuited.		Check the wiring.	p.40	
Input error	No input signal received.	Cables are not connected correctly.	Check the input circuit and the wiring for proper connection.	p.40
		The signal line is disconnected.		

Error type	Phenomenon	Cause	Countermeasure	Pages
Output error	The judgment result cannot be output to an external device.	Cables are not connected correctly.	Check the output circuit and the wiring for proper connection.	p.40
		The signal line is disconnected.		–
		The signal logic is not correct.	Check the logic of the signal.	–
		The RESET input line is short-circuited.	Check the input circuit and the wiring for proper connection.	p.40
		The non-measurement setting is set to "CLAMP", and measurement cannot be performed.	Set the non-measurement setting correctly. By selecting the non-measurement setting to "KEEP", the judgment result before measurement is disabled can be output.	p.150
	The analog output is not correct.	Cables are not connected correctly.	Check the output circuit and the wiring for proper connection.	p.43
		The signal line is disconnected.		–
		The voltage and current values are off the meter.	Set the correct monitor focus based on the measured value.	p.140
An oscilloscope or a high-speed A/D board is being used.		Use of these devices may reduce the resolution. Change the monitor focus to minimize the affect.	p.140	
Communication error	RS-232C communication cannot be established.	Cable wirings are wrong. Cables are not connected correctly.	Check the wiring to ensure proper connection.	–
		Communication settings are wrong.	Set the same communication setting for both the Sensor Controller and the external devices.	p.173
	Ethernet communication cannot be established.	The Ethernet cable is not connected correctly.	Use a cross cable when connecting the Sensor Controller directly with the personal computer.	–
		The IP address and subnet mask are not set correctly.	Set the IP address and subnet mask correctly. * To enable the settings, restart the Sensor Controller.	p.170
		The Sensor Controller and an external device are not connected at a 1:1 ratio.	Connect the Sensor Controller and an external device at a 1:1 ratio.	–
		The Ethernet cable is disconnected or about to be disconnected.	Check if the Ethernet cable is disconnected.	–
		The industrial switching hub is faulty (when the switching hub is used).	Check if the industrial switching hub is faulty.	–
The security setting is not appropriate.	Check if the communication is blocked due to the firewall setting on the external device.	–		
Other	Key input is not allowed.	The key lock setting is turned ON.	Turn OFF the key lock setting.	p.111 p.261

Sensor controller operations

9-1 Search from Menu Tree	214
9-2 Functions of Operating Keys	220
9-3 Digital Displays	221
9-4 Switching operation modes	222
9-5 Functions and Operations during Measurement	224
9-6 Setting Sensing	228
9-7 Setting Measurement Items	231
9-8 Setting the Output Conditions	236
9-9 Setting the Banks	252
9-10 Setting Threshold Value	257
9-11 Setting the System	260
9-12 Connecting Parallel I/O	264
.....	276
9-13 Connecting by No-protocol Communications	277

9-1 Search from Menu Tree

FUN Mode Menu

* - default value

		Setting	Option/Setting Range	Pages		
Sensing setting [SENS]	Material [OBJECT]	Material [OBJECT]	Normal [NORMAL]*/ Mirror surface [MIRROR]/ Diffusion surface [DIFF]	p.228		
		Exposure time control mode [EXPOSE]	Auto* [AUTO]	Upper limit [UPPER]	1 to 5000 μs (default value: 1000)	p.230
	Manual [MANUAL]		Fixed exposure time [TIME]	1 to 5000 μs (default value: 1000)	p.230	
	Start direction of count measurement surfaces [SUR, DIR]	Start direction of count measurement surfaces [SUR, DIR]	NEAR [NEAR]*/FAR[FAR]	p.230		
Measurement setting [MEAS]	TASK1 [TASK1]	Measurement item [ITEM]	Height [HEIGHT]	Measurement surface [SUR]	Edge 1st [EDGE1]/Edge 2nd [EDGE2]/Edge 3rd [EDGE3]/Edge 4th [EDGE4]/Light Peak [PEAK]	p.231
			Thick [THICK]	Surface 1 [TOP]	Edge 1st [EDGE1]/Edge 2nd [EDGE2]/Edge 3rd [EDGE3]/Edge 4th [EDGE4]/Light Peak [PEAK]	p.232
				Surface 2 [END]	Edge 1st [EDGE1]/Edge 2nd [EDGE2]/Edge 3rd [EDGE3]/Edge 4th [EDGE4]/Light Peak [PEAK]	
			Calculation [CALC]	Parameter K [PARAM.K]	-999.999999 to 999.999999 mm (default value: 0)	p.233
				Parameter m [PARAM.M]	-10.0 to 10.0 (default value: 0)	
				Parameter n [PARAM.N]	-10.0 to 10.0 (default value: 0)	
				Parameter X [PARAM.X]	None [OFF]*/TASK1 [TASK1]/TASK2 [TASK2]/TASK3 [TASK3]/TASK4 [TASK4]	
				Parameter Y [PARAM.Y]	None [OFF]*/TASK1 [TASK1]/TASK2 [TASK2]/TASK3 [TASK3]/TASK4 [TASK4]	
			None [NONE]	-	-	-
			Filer [FILTER]	Median [MEDIAN]	Off [OFF]*/Low [LOW]/Mid [MID]/High [HIGH]	p.236
				Average [AVE]	1/2/4/8/16/32/64/128/256*/512/1024/2048/4096	p.237
Differential [DIFFER]	Off [OFF]*/On [ON]	p.239				
Differential cycle [CYCLE]	1 to 5000 ms (default value: 1)					
Frequency [FREQ]	Off [OFF]*/Lowpass [LOPASS]/Highpass [HIPASS]/Bandpass [BDPASS]	p.238				
Cutoff frequency [CUTOFF]	Lowpass/highpass: 0.001 to 999.999Hz (default value: 0.001) Bandpass: 0.001 to 999.999Hz (default value: upper limit 999.999/lower limit 0.001)					

Setting	Option/Setting Range	Pages
Measurement setting [MEAS] (cont'd)		
TASK1 [TASK1] (cont'd)		
Output [OUTPUT]		
Scaling [SCALE]		
Auto [AUTO]	-	p.240
One-point scaling [1PT]	-	
Direction [DIR]	Forward [FWD]*/Reverse [REV]	
Two-point scaling [2PT]	-	
Manual [MANUAL]	-	
Span [SPAN]	-2.0000 to 2.0000 (default value: 1.0000)	
Offset [OFFSET]	-999.999999 to 999.999999 mm (default value: 0)	
Thick [THICK]	-	
Off [OFF]*	-	
Hold [HOLD]		
Type [TYPE]	Off [OFF]/Peak [PEAK]/Bottom [BOTTOM]/Peak to peak [P-P]/Auto peak [A.PEAK]/Auto bottom [A.BOTTM]/Auto peak to peak [A.P-P]/Average [AVE]/Sampling [SAMPLE]	p.244
Trigger [TRIG]	Timing [TIMING]/Self up trigger [SELF-U]/Self down trigger [SELF-D]	p.245
Trigger level [LEVEL]	-999.999999 to 999.999999 mm (default value: 0)	
Trigger Hysteresis [HYS]	0 to 999.999999 mm (default value: 0.05% of measuring range)	
Delay [DELAY]	Off [OFF]*/On [ON]	p.247
Delay time [DL.Y.TIM]	1 to 5000 ms (default value: 1 ms)	
Sampling time [SMP.TIM]	1 to 5000 ms (default value: 100 ms)	
Zero reset [ZERO]		
Type [TYPE]	Real value [REAL]/Hold value [HOLD]	p.250
Offset [OFFSET]	-999.999999 to 999.999999 mm (default value: 0)	p.249
Status [STATUS]	Off [OFF]/On [ON]*	p.248
Threshold [JUDGE]		
Teaching [TEACH]		
High threshold [H.JUDGE]	-999.999999 to 999.999999 mm (default value: +25% of measuring range)	p.257
Low threshold [L.JUDGE]	-999.999999 to 999.999999 mm (default value: -25% of measuring range)	
Direct [DIRECT]		
High threshold [H.JUDGE]	-999.999999 to 999.999999 mm (default value: +25% of measuring range)	p.259
Low threshold [L.JUDGE]	-999.999999 to 999.999999 mm (default value: -25% of measuring range)	
TASK2 [TASK2]	(Same content as TASK1)	
TASK3 [TASK3]	(Same content as TASK1)	
TASK4 [TASK4]	(Same content as TASK1)	

		Setting	Option/Setting Range	Pages		
I/O setting [I/O]	Non-measurement setting [HLD.RST]	Non-measurement setting [HLD.RST]	Keep [KEEP]/Clamp [CLAMP]*	p.273		
		Analog output [ANALOG]	Current output: MIN [MIN] (approx. 3.4 mA)/4mA/5mA/.../19mA/20mA/MAX [MAX] (approx. 21mA) (default value: MAX) Voltage output: MIN [MIN] (approx. -10.8V)/-10V/-9V/.../9V/10V/MAX [MAX] (approx. 10.8V) (default value: MAX)	p.274		
		Binary output [BINARY]	MAX [MAX] */MIN [MIN]	p.268		
	Judgment [JUDGE]	Output target [OUTPUT]	Output target [OUTPUT]	TASK1 [TASK1] /TASK2 [TASK2]/TASK3 [TASK3]/TASK4 [TASK4]	p.271	
		Hysteresis [HYS]	Hysteresis [HYS]	0 to 99.9999 mm (default value: 0.05% of measuring range)	p.272	
		Timer [TIMER]	TIMER [TIMER]	Off [OFF]/Off delay [OFF.DLY]/On delay [ON.DLY]/One shot [1SHOT]	p.272	
		Timer time [TIME]	1 to 5000 ms (default value: 1)			
	Analog output [ANALOG]	Output destination [V OR C]	Output destination [V OR C]	Voltage output [VOLT] */Current output [CUR]	p.264	
		Output target [OUTPUT]	Output target [OUTPUT]	Off [OFF]/TASK1 [TASK1] /TASK2 [TASK2]/TASK3 [TASK3]/TASK4 [TASK4]	p.265	
		Monitor focus [FOCUS]	Focus [FOCUS]	Focus [FOCUS]	Off [OFF]*/On [ON]	p.265
			Focus current/voltage 1 [CUR1]/[VOLT1]	Focus current/voltage 1 [CUR1]/[VOLT1]	Current: 4/5/6/7/8/9/10/11/12/13/14/15/16/17/18/19/20mA (default value: 4mA) Current: -10/-9/-8/-7/-6/-5/-4/-3/-2/-1/0/1/2/3/4/5/6/7/8/9/10V (default value: -10V)	
			Measurement value 1 [MEAS1]	Measurement value 1 [MEAS1]	-999.999999 to 999.999999 mm (default value: -0.5)	
			Focus current/voltage 2 [CUR2]/[VOLT2]	Focus current/voltage 2 [CUR2]/[VOLT2]	Current: 4/5/6/7/8/9/10/11/12/13/14/15/16/17/18/19/20mA (default value: 20mA) Current: -10/-9/-8/-7/-6/-5/-4/-3/-2/-1/0/1/2/3/4/5/6/7/8/9/10V (default value: 10V)	
		Measurement data2 [MEAS2]	Measurement data2 [MEAS2]	-999.999999 to 999.999999 mm (default value: 0.5)		
	Calibration [CALIB]	Calibration [CALIB]	Off*/On	p.267		
	Calibration current/voltage 1 [CUR1]/[VOLT1]	Calibration current/voltage 1 [CUR1]/[VOLT1]	Current: 4/5/6/7/8/9/10/11/12/13/14/15/16/17/18/19/20mA (default value: 4mA) Current: -10/-9/-8/-7/-6/-5/-4/-3/-2/-1/0/1/2/3/4/5/6/7/8/9/10V (default value: -10V)			
	Calibration value 1 [ADJ1]	Calibration value 1 [ADJ1]	-999 to 999 (default value: 0)			
	Calibration current/voltage 2 [CUR2]/[VOLT2]	Calibration current/voltage 2 [CUR2]/[VOLT2]	Current: 4/5/6/7/8/9/10/11/12/13/14/15/16/17/18/19/20mA (default value: 20mA) Current: -10/-9/-8/-7/-6/-5/-4/-3/-2/-1/0/1/2/3/4/5/6/7/8/9/10V (default value: 10V)			
	Calibration value 2 [ADJ2]	Calibration value 2 [ADJ2]	-999 to 999 (default value: 0)			

* The same "OUTPUT" is set for all banks. The output destination cannot be set separately for individual banks.

			Setting	Option/Setting Range	Pages
I/O setting [I/O] (cont'd)	Binary output [BINARY]	Data output setting [COM.OUT]	Output object [OUTPUT]	Measurement value 1 [MEAS1] (TASK1(ON*/OFF), TASK2 to TASK4 (ON/OFF*/))/Measurement value 2 [MEAS2]/Judgment value [JUDGE]/ Off [OFF] *	p.268
			TASK1 to 4 [TASK1] to [TASK4]	Off [OFF] */On [ON]	p.268
		Decimal point digit [DEC.NUM]	Decimal point digit [DEC.NUM]	0 [0DIG] to 6 [6DIG] (Default: 5 [5DIG])	p.269
		Output cycle [CYCLE]	Output cycle [CYCLE]	1 to 100 (Default: 1)	p.270
		GATE Period [GATE]	GATE Period [GATE]	0.1 to 100.0 ms (Default: 0.1)	p.270
		Data output setting [COM.OUT]	Output data format [FORMAT]	ASCII[ASCII]*/Binary[BINARY]	-
			Number of integer digits [INT.NUM]	1 / 2 / 3 / 4 / 5*	-
			Fractional digits [DEC.NUM]	0 / 1 / 2 / 3 / 4 / 5 / 6*	-
			Leading zeros suppressed. [ZEROSP]	Off* /On	-
			Field separator [FIELD]	None [NO]*/Comma [COMMA]/ Tab [TAB]/Space [SPACE]/ CR[CR]/LF[LF]/CR+LF[CRLF]/ Semicolon [SEMICO]	-
		Record separator [RECORD]	None [NO]*/Comma [COMMA]/ Tab [TAB]/Space [SPACE]/ CR[CR]/LF[LF]/CR+LF[CRLF]/ Semicolon [SEMICO]	-	
	LOGGING [PAR.LOG]	Save intervals [INTRVL]	0 to1000	p.275	
		Save count [COUNT]	0 to12800	p.275	
Bank setting [BANK]	Bank change [BK.CHG]	Bank number [BANK]	Bank1 [BANK1] to Bank8 [BANK8] (default value: Bank1) Up to Bank32 can be selected when the bank mode is "JUDGE".	p.252	
		Bank mode [BK.MODE]	Normal [NORMAL]*/ Judgment value [JUDGE]	p.253	
		Bank copy [BK.COPY]	Copy source [FROM]	Bank1 [BANK1] to Bank8 [BANK8]	p.254
			Copy destination [TO]	Bank1 [BANK1] to Bank8 [BANK8]	
	Bank clear [BK.CLR]	Bank clear [BK.CLR]	Ok [OK]/Cancel [CAN]	p.256	

		Setting	Option/Setting Range	Pages	
System setting [SYSTEM] (cont'd)	Save [SAVE]	Save [SAVE]	OK [OK]/Cancel [CAN]	p.255	
	Initialization [INIT]	Initialization [INIT]	OK [OK]/Cancel [CAN]	p.263	
	Communications [COM]	RS-232C [RS232C]	Data length [DATA]	7bit [7BIT]/8bit [8BIT]*	p.278
			Parity [PARITY]	None [OFF]/Odd [ODD]/Even [EVEN]	
			Stop bit [STOP]	1bit [1BIT]* /2 bit [2BIT]	
			Baud rate [BAUD.RT]	9600/19200/38400*/57600/115200	
			CS/RS [CS/RS]	Off [OFF]/On [ON]	
	Ethernet [ETN]		IP address 1 [IPADDR] [IP1]	1 to 233 (default value: 192)	p.277
			IP address 2 [IP2]	0 to 255 (default value: 168)	
			IP address 3 [IP3]	0 to 255 (default value: 250)	
			IP address 4 [IP4]	1 to 254 (default value: 50)	
			Subnet mask1 [SUBNET] [SUB1]	0 to 255 (default value: 255)	
			Subnet mask2 [SUB2]	0 to 255 (default value: 255)	
Subnet mask3 [SUB3]			0 to 255 (default value: 255)		
Subnet mask4 [SUB4]			0 to 255 (default value: 0)		
Subnet mask4 [SUB4]			0 to 255 (default value: 0)		
Protocol selection [PROTCL]			Off [OFF]/ TCP/Server [TCP.SV]*/TCP/Client [TCP.CL]/UDP [UDP]		
Output IP address 1 [OUTIP] [IP1]			1 to 233 (default value: 192)		
Output IP address 2 [IP2]			0 to 255 (default value: 168)		
Output IP address 3 [IP3]			0 to 255 (default value: 250)		
Output IP address 1 [IP4]			1 to 254 (default value: 100)		
Port numbers [PORT.IN]	0 to 65535 (default value: 9601)				
Output destination port No. [PORT.OT]	0 to 65535 (default value: 9601)				
Delimiter [DELIMI]	Delimiter [DELIMI]	CR [CR] ^/LF [LF]/CR+LF [CRLF]	p.280		













		Setting	Option/Setting Range	Pages
System setting [SYSTEM]	Sensor head Calibration [H.CALIB]	Sensor head calibration [H.CALIB]	OK [OK]/Cancel [CAN]	p.262
	Key lock [LOCK]	Key lock [LOCK]	Off [OFF]*/On [ON]	p.261
	Zero reset MEMORY [ZER.MEM]	Zero reset memory [ZER.MEM]	Off [OFF]*/On [ON]	p.251
	TIMING/ RESET key input [KEY.IN]	TIMING/ RESET key input [KEY.IN]	OFF [OFF]*/ON [ON]	p.246
	Measuring cycle [CYCLE]	Measuring cycle [CYCLE]	Displays the current measuring cycle. 500 to 10000 μs (default value: 2000)	p.260
	Controller information [C.INFO]	Software version [VER]	Software version [VER]	Displays the version.
MAC Address [MAC.ADR]		MAC Address [MAC.ADR]	Displays the current MAC address.	
Error history [ERR.LOG]		Error history [ERR.LOG]	Clears/displays the error history.	-
Error history display [LOG.DSP]		Error history display [LOG.DSP]	No.01 to No.64 (default value: No.01)	-
Error clear [LOG.CLR]		Error clear [LOG.CLR]	OK [OK]/Cancel [CAN]	-
Sensor head information [H.INFO]	Model [MODEL]	Model [MODEL]	Displays the model.	p.260
	Serial No. [SER.NO]	Serial No. [SER.NO]	Displays the serial No..	

RUN (run) Mode Menu

Setting [DISPLAY]	Option/Setting Range [DISPLAY]	Pages
Task for displayed target [DISP]	TASK1/TASK2/TASK3/TASK4	p.226
HIGH threshold value [H.JUDGE]	Sensor Controller: -999.99 to 999.999 Smart Monitor ZW: -999.999999 to 999.999999	p.227
LOW threshold value [L.JUDGE]	Sensor Controller: -999.99 to 999.999 Smart Monitor ZW: -999.999999 to 999.999999	p.227
Decimal point digit [DEC.NUM]	0[0DIG]/1 [1DIG]/2 [2DIG]/3 [3DIG]/4 [4DIG]/5 [5DIG]	p.226







9-2 Functions of Operating Keys

The following table lists the names and functions of the operating keys on the Sensor Controller:

Name	Function		
	RUN Mode	FUN Mode	
← (LEFT) key → (RIGHT) key	 	Changes sub-display content.	Functions differently depending on the settings. <ul style="list-style-type: none"> • Function display switching • Numerical value digit selection • Setting cancellation
↑ (UP) key ↓ (DOWN) key	 	 key: Executes TIMING input.  key: Executes RESET input. <p>* These keys are available only if key inputs for the hold functions have been enabled in the FUN mode.</p>  Performing Hold with a Key Input p.99	Functions differently depending on the settings. <ul style="list-style-type: none"> • Selection menu switching • Setting value selection
Mode switching key		Hold down for at least two seconds to enter the FUN mode.	Hold down for at least two seconds to enter the RUN mode. <ul style="list-style-type: none"> • For operating mode switching, "SWITCH" is displayed on the main display and "OK/CAN" is displayed on the sub-display. Press the ZERO/SET key to switch the mode.  <ul style="list-style-type: none"> • When the mode is switched from FUN mode to RUN mode, "SAVE" is displayed on the main display and "OK/CAN" is displayed on the sub-display. Press the ZERO/SET key to save the settings and switch the operating mode.  <p>Press the ZERORST/ESC key to switch the operating mode without saving the settings. If you press for less than 2 seconds, the display shifts to RUN mode task switching and the threshold value setting menu. Also, this starts teaching to set threshold values when setting a threshold value.</p>
ZERO/SET key		Executes a zero reset.	Functions differently depending on the selections. <ul style="list-style-type: none"> • Application of selection conditions and numerical values • Switching to lower menus
ZERORST/ESC key		Hold down for at least two seconds to cancel a zero reset.	Functions differently depending on the selections. <ul style="list-style-type: none"> • Cancellation of selection conditions and numerical values • Switching to upper menus Hold down for at least two seconds to jump to the top menu on the FUN mode.

9-3 Digital Displays

The theme displayed on the main or sub-display varies depending on the currently selected operating mode. The following table lists the theme displayed, when turning the Sensor Controller ON, or in the RUN or FUN mode.

Operation mode	Main display (upper line, in red)	Sub-display (lower line, in green)
When turning ON	The Sensor Controller model name, "ZW-C" appears.	During the initialization, "START" is displayed.
The system enters the RUN mode after displaying "INIT" for a few seconds.		
RUN mode	The task measurement result appears. The task to display can be toggled.  Changing Display Details p.226	Press the  /  key to cycle through the sequence of the HIGH and LOW threshold values, analog output (voltage/current), judgment result, resolution (the max. and min. values for 1-min measured value), exposure time, distance (Sensor Head to the object to measure), effective bank, and displayed task in descending or ascending order.
Press and hold the  key for two seconds or more to switch between the RUN and FUN modes.		
FUN mode	Press the  /  keys to cycle through the function names in descending or ascending order.	When reaching the lowest layer, the setting value displayed on the main display appears.

Alphabetical notation

Alphabet characters are displayed on the main and sub-display as follows:

A	B	C	D	E	F	G	H	I	J	K	L	M
<i>A</i>	<i>b</i>	<i>C</i>	<i>d</i>	<i>E</i>	<i>F</i>	<i>G</i>	<i>H</i>	<i>I</i>	<i>J</i>	<i>K</i>	<i>L</i>	<i>M</i>
N	O	P	Q	R	S	T	U	V	W	X	Y	Z
<i>N</i>	<i>O</i>	<i>P</i>	<i>Q</i>	<i>R</i>	<i>S</i>	<i>T</i>	<i>U</i>	<i>V</i>	<i>W</i>	<i>X</i>	<i>Y</i>	<i>Z</i>

9-4 Switching operation modes

 3-3 Switching operation modes p.57

Use  key to switch between the operation modes.
The RUN indicator identifies the current operation mode.

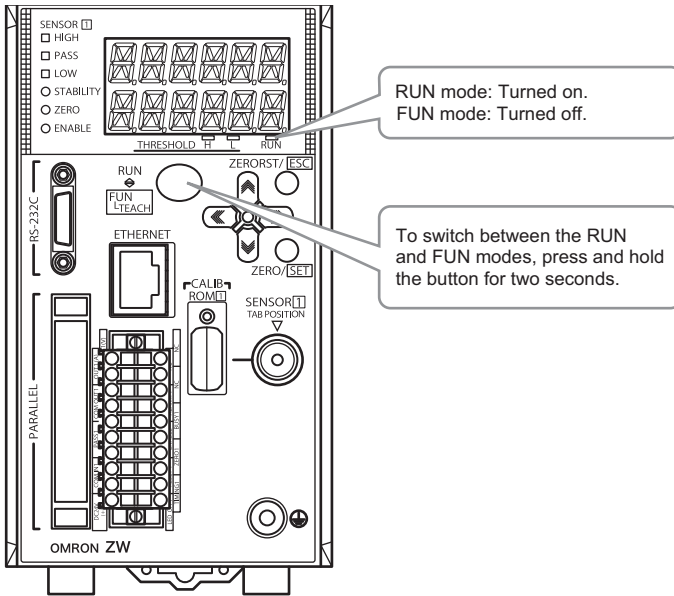

Entering Numerical Values

To enter numerical values, including parameters, for the sub-display, follow the steps below:

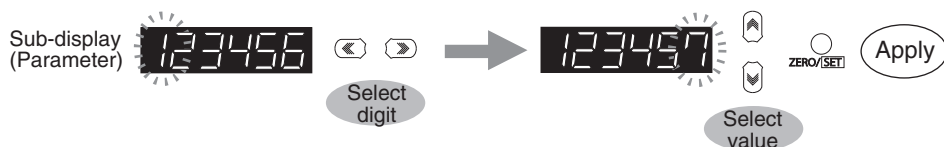

- (1) When entering numerical values, the sub-display displays the current setting value and its uppermost digit flashes.
- (2) Press the / keys to select a digit to enter a number.
Press the key on the rightmost digit to move blinking to the leftmost digit.
Press the key on the leftmost digit to move blinking to the rightmost digit.
- (3) Press the / keys to select a digit to enter a number.
- (4) Press the key to apply the entered value.

Positioning decimal point

To position a decimal point, follow the steps below:

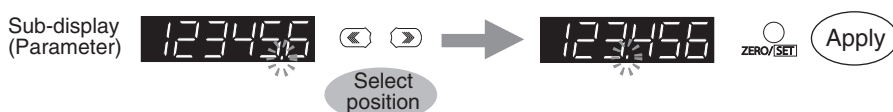

- (1) If a decimal point has been defined, it flashes on the sub-display.
- (2) Press the / keys to position the decimal point.
Position the decimal point at the rightmost digit to erase it.
Press the key on the rightmost digit to move blinking to the leftmost digit.
Press the key on the leftmost digit to move blinking to the rightmost digit.
- (3) Press the key to apply the position of the decimal point.

9-5 Functions and Operations during Measurement

Switching the RUN (Run) Mode Display

In the RUN mode, you can switch the measured value display by pressing the \leftarrow / \rightarrow keys during the operation. You can check the threshold value and analog output value while displaying the measured value on the main display.

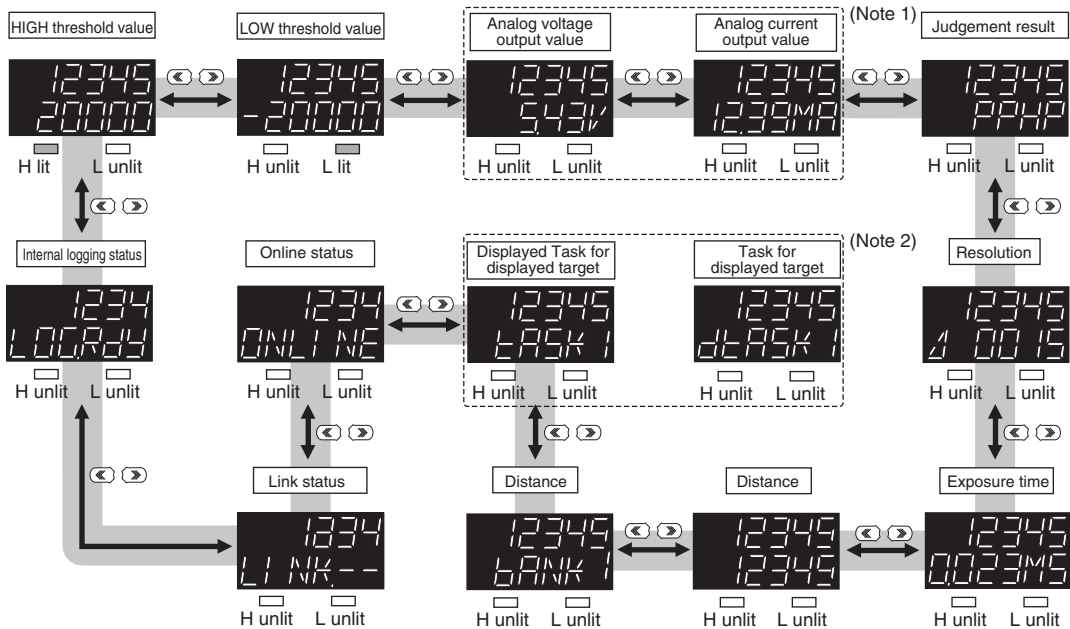

The above display screenshots are only samples and may differ from actual displays.

(Note 1) An output item not selected on the analog output (Voltage output/Current output) is displayed as "-----" on the sub-display. For example, if "Voltage output" is selected on the analog output, the analog current output value is displayed as "-----" on the sub-display.

(Note 2) "Displayed task" can be selected from TASK1 to TASK4. "Task for displayed target" is displayed as "dTASK□." □ indicates the task number. (Refer to p.226 for the task for displayed target.) If the task for displayed target is TASK2, for example, "TASK1," "dTASK2," "TASK3" and "TASK4" will be displayed.

Details Displayed on the Main Display

The measured values always appear on the main display.

The measured values are initialized as follows:

- Reference value "0": Measurement center distance
- + display: NEAR (close range) side
- - display: FAR (far range) side

However, in the following cases, the measurement values are not displayed.

- When the amount of light received is inadequate, "DARK" is displayed; when the sensor is saturated, "BRIGHT" is displayed.
- When there is no surface present to measure, "NO.SRFC" is displayed.
- When the measurement LED is OFF, "LEDOFF" is displayed.
- When the measurement surface is far outside the measurement range or if no hold value is finalized when hold is set, then "-----" is displayed.

Details Displayed on the Sub-display

The items listed in the following table appears on the sub-display.

Press the ◀ / ▶ keys to toggle the display.

Display Details	Description
Threshold	Displays the HIGH and LOW threshold values for tasks for displayed target. THRESHOLD-H indicator lights for the HIGH threshold value. THRESHOLD-L indicator lights for the LOW threshold value.
Analog output	Displays the voltage or current value output in analog format. The display details for the output destination setting are different for voltage output and for current output. (Values displayed here are reference values only. These values differ from actual analog output values.)
Judgment result	The judgment result for each task appears. The TASK1, 2, 3 and 4 judgment results are displayed starting from the left. H: HIGH P: PASS L: LOW E: ERROR
Resolution	Displays the fluctuation width (peak to peak) of the measured value over a fixed amount of time.
Exposure time	Displays the current exposure time. The time is displayed in the range 1 to 5000 μs.
Distance	Displays the distance from the Sensor Head to a target to measure.
Effective bank	Displays the current bank number.
Displayed task	Displays the currently selected task number from TASK1 to TASK4. The measured value for the selected task appears on the main display.
Ethernet communication status	Whether Ethernet communications are possible is displayed. ONLINE: Communication possible OFFLINE: Communication not possible
Ethernet link status	Whether the Ethernet connection is enabled is displayed. LINK.OK: Connection established LINK.--: Connection not established
Internal logging status	Displays the status of operation internal logging. LOG.RDY : Internal logging stopped state (When ZW start, When internal logging data is cleared, When internal logging stopped) LOG.RUN : Internal logging in progress LOG.END : Internal logging ended state(When internal logging is automatically ended)













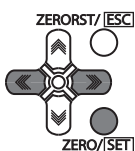

Changing Display Details

The measurement result displayed on the main display in RUN mode can be selected from TASK1 to 4. The number of digits displayed can also be changed.

Setting [DISPLAY]	Option [DISPLAY]
Task for displayed target [DISP]	TASK1/TASK2/TASK3/TASK4
Decimal point digit [DEC.NUM]	0 [0DIG]/1 [1DIG]/2 [2DIG]/3 [3DIG]/4 [4DIG]/5 [5DIG]

As an example, here is an explanation of the procedure for setting TASK2 as the task to be displayed target.

Operating procedure

Steps	Key operation	Display	Description
1			Press the  key in the RUN mode to display the setting menu.
2			Press the  /  keys to select "DISP" and press the  key.
3			Select the task to be the displayed target. The current setting value is displayed on the sub-display. Press  /  key to enter editing mode and the sub-display blinks. Select "TASK2" and press the  key.
4			Press the  key to leave the setting menu.

Changing Threshold Values

The threshold value for the task displayed on the main display in the RUN mode can be changed.













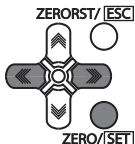

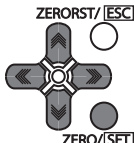

Important

To change the target task, change the task displayed on the main display.

 Changing Display Details p.226

As an example, here is an explanation of the procedure for setting the HIGH threshold value by entering "1.000" directly.

Operating procedure

Steps	Key operation	Display	Description
1			Press the  key in the RUN mode to display the setting menu.
2			Press the  /  key to select H.JUDGE, then press the  key.
3			Set "1.000" as the HIGH threshold value. The current measured value is displayed on the main display and the current set threshold value is displayed on the sub-display. (At this time, the THRESHOLD-H indicator lights up.) Press  key to enter the editing mode, and the sub-display blinks. To edit numerical values, use the  /  /  /  keys. Input "1.000", then press the  key.
4			Press the  key to leave the setting menu.



















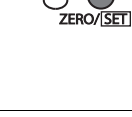

9-6 Setting Sensing

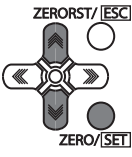
Setting the Material of the Target to Measure

 Setting the Material of the Target to Measure p.71

As an example, here is an explanation of the procedure for the "MIRROR" setting as the material.

Operating procedure













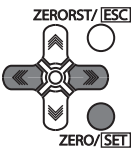

Steps	Key operation	Display	Description
1			Press and hold the  key for two seconds to enter the FUN mode.
2			Press the  /  keys to select "SENS" and press the  key.
3			Press the  /  keys to select "OBJECT" and press the  key.
4			Select the material. NORMAL: Normal MIRROR: Mirror DIFF: Diffusion surface The current setting value is displayed on the sub-display. Press  /  key to enter editing mode and the sub-display blinks. In this example, select "MIRROR" and press the  key.
5			Press the  key for two seconds to enter the RUN mode.

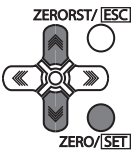
Setting Start Direction of Count Measurement Surfaces

 Setting Start Direction of Count Measurement Surfaces p.74

As an example, here is an explanation of the procedure for setting start direction of count measurement surface to "NEAR".

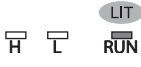
Operating procedure



















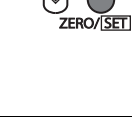



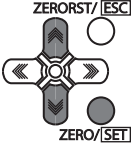

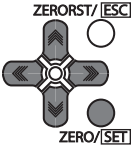

Steps	Key operation	Display	Description
1			Press and hold the  key for two seconds to enter the FUN mode.
2			Press the  /  keys to select "SUR.DUR" and press the  key.
3			Select the material. NEAR: NEAR direction FAR: FAR direction The current setting value is displayed on the sub-display. Press  /  key to enter editing mode and the sub-display blinks. In this example, select "NEAR" and press the  key.
4			Press the  key for two seconds to enter the RUN mode.

Setting Exposure Time Control Mode

 Setting Exposure Time Control Mode p.75

As an example, here is an explanation of the procedure for setting the exposure time control mode to "AUTO" and the exposure time (maximum) to "500 μ s".

Operating procedure

Steps	Key operation	Display	Description
1			Press and hold the  key for two seconds to enter the FUN mode.
2			Press the  /  keys to select "SENS" and press the  key.
3			Press the  /  keys to select "EXPOSE" and press the  key.
4			Select the exposure time control mode. AUTO: Automatic MANUAL: Fixed The current setting value is displayed on the sub-display. Press  /  key to enter editing mode and the sub-display blinks. In this example, select "AUTO" and press the  key.
5			Set the exposure time (maximum) or exposure time (fixed). In this example, "UPPER" is displayed on the main display, and the current setting value is displayed on the sub-display. Press  key to enter the editing mode, and the sub-display blinks. To edit numerical values, use the  /  /  /  keys. In this example, select "500" and press the  key.
6			Press the  key for two seconds to enter the RUN mode.

9-7 Setting Measurement Items

Measuring the Height

Measuring the Height p.79

As an example, here is an explanation of the procedure for measuring the height of the surface (2nd surface) below a transparent object (as shown in the diagram on p.79).

Operating procedure















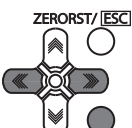



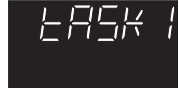







Steps	Key operation	Display	Description
1			Press and hold the key for two seconds to enter the FUN mode.
2			Press the key to select MEAS, then press the key.
3			Press the key to select TASK1, then press the key.
4			Press the key to select "ITEM" and press the key.
5			Press the key to select "HEIGHT" and press the key.
6			Select the measurement surface. EDGE1 to EDGE4: 1st surface to 4th surface PEAK: Peak "SUR" is displayed on the main display and the current setting value is displayed on the sub-display. Press key to enter editing mode and the sub-display blinks. In this example, select "EDGE2" and press the key.
7			Press the key for two seconds to enter the RUN mode.

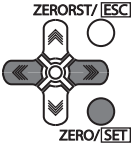











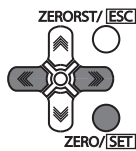

Measuring the Thickness

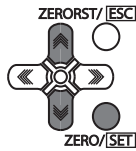
 Measuring the Thickness p.81

As an example, here is an explanation of the procedure for measuring the thickness from the top surface of glass on which specular reflection occurs as the 1st surface to the 2nd surface (as shown in the diagram on p.81).

Operating procedure

Steps	Key operation	Display	Description
1			Press and hold the  key for two seconds to enter the FUN mode.
2	Set the material of the target to "MIRROR." Optional  Setting the Material of the Target to Measure p.228 If the target object is a transparent object, such as glass, on which specular reflection occurs, set the material of the measurement object to "MIRROR" to obtain more accurate measurement result.		
3	Set the surface to "SUR.1ST."		
3-1			Press the  key to select MEAS, then press the  key.
3-2			Press the  key to select TASK1, then press the  key.
3-3			Press the  keys to select "ITEM" and press the  key.
3-4			Press the  keys to select "THICK" and press the  key.
3-5			Select "SUR1." Press the  keys to select "TOP" and press the  key.
3-6			Select the measurement surface. EDGE1 to EDGE4: 1st surface to 4th surface PEAK: Peak The current setting value is displayed on the sub-display. Press  key to enter editing mode and the sub-display blinks. In this example, select "EDGE1" and press the  key.
4	Set the surface2 to "SUR.2ND."		

Steps	Key operation	Display	Description
4-1			Press the  key to return to the previous menu.
4-2			Select "SUR2." Press the  /  keys to select "END" and press the  key.
4-3			Select the measurement surface. The current setting value is displayed on the sub-display. Press  /  key to enter editing mode and the sub-display blinks. In this example, select "EDGE2" and press the  key.
5	Scaling setting  Setting Scaling p.83		
6			Press the  key for two seconds to enter the RUN mode.

Calculating

 Performing Calculations p.82

As an example, here is an explanation of the output of the calculation result below.

(Example)

When calculating the amount of convexity and concavity on the object surface from the difference between the average value and the peaks and outputting this to TASK3







TASK1: Surface peak hold





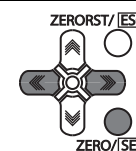





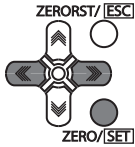













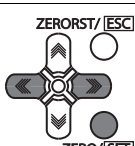



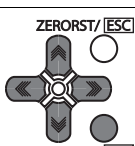







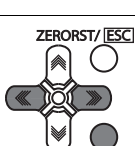







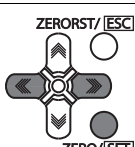

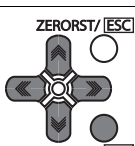

TASK2: Surface average hold











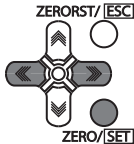



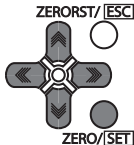









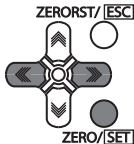



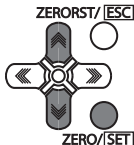







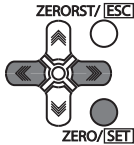

TASK3: TASK1 - TASK2 setting

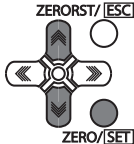
- PARAMETER K: 0
- PARAMETER m: 1
- PARAMETER n: -1
- PARAMETERX: TASK1
- PARAMETERY: TASK2

Operating procedure

Steps	Key operation	Display	Description
1			Press and hold the  key for two seconds to enter the FUN mode.
2			Press the  /  key to select MEAS, then press the  key.

Steps	Key operation	Display	Description
3	 Setting Hold p.94		Sets the surface peak hold for TASK1 and the surface average hold for TASK2.
4			Press the  /  keys to select "TASK3" and press the  key.
5			Press the  /  keys to select "ITEM" and press the  key.
6			Press the  /  keys to select "CALC" and press the  key.
7			Select "PARAM.K" for the parameter type. Press the  /  keys to select "PARAM.K" and press the  key.
8			Set the parameter to "0". The current setting value is displayed on the sub-display. Press  key to enter the editing mode, and the sub-display blinks. To edit numerical values, use the  /  /  /  keys. Input "0", then press the  key.
9			The decimal point is displayed. Press the  /  key to move the decimal point. Determine the decimal point and then press the  key.
10			Press the  key to return to the previous menu.
11			Select "PARAMm" for the parameter type. Press the  /  keys to select "PARAM.M" and press the  key.
12			Set the parameter to "1". The current setting value is displayed on the sub-display. Press  key to enter the editing mode, and the sub-display blinks. To edit numerical values, use the  /  /  /  keys. Input "1", then press the  key.
13			Press the  key to return to the previous menu.

Steps	Key operation	Display	Description
14			Select "PARAMn" for the parameter type. Press the  /  keys to select "PARAM.N" and press the  key.
15			Set the parameter to "-1". The current setting value is displayed on the sub-display. Press  key to enter the editing mode, and the sub-display blinks. To edit numerical values, use the  /  /  /  keys. Input "-1", then press the  key.
16			Press the  key to return to the previous menu.
17			Select "PARAM.X" for the parameter type. Press the  /  keys to select "PARAM.X" and press the  key.
18			Set the parameter to "TASK1". The current setting value is displayed on the sub-display. Press  /  key to enter editing mode and the sub-display blinks. Select "TASK1" and press the  key.
19			Press the  key to return to the previous menu.
20			Select "PARAMY" for the parameter type. Press the  /  keys to select "PARAM.Y" and press the  key.
21			Set the parameter to "TASK2". The current setting value is displayed on the sub-display. Press  /  key to enter editing mode and the sub-display blinks. Select "TASK2" and press the  key.
22			Press the  key for two seconds to enter the RUN mode.

9-8 Setting the Output Conditions

Setting the Filter











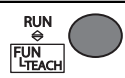



















 Setting Filters p.89

Setting the Median Filter

 Setting the Median Filter p.90

As an example, here is an explanation of the procedure for selecting the "MID" median filter setting.

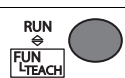
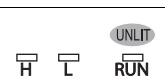
Operating procedure











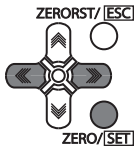

Steps	Key operation	Display	Description
1			Press and hold the  key for two seconds to enter the FUN mode.
2			Press the  /  key to select MEAS, then press the  key.
3			Press the  /  keys to select "TASK1" and press the  key.
4			Press the  /  keys to select "FILTER" and press the  key.
5			Select "MEDIAN" as the filter type. Press the  /  keys to select "MEDIAN" and press the  key.
6			Select the filter mode from the following: OFF / LOW / MID / HIGH The current setting value is displayed on the sub-display. Press  /  key to enter editing mode and the sub-display blinks. In this example, select "MID" and press the  key.
7			Press the  key for two seconds to enter the RUN mode.

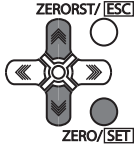
Setting the Average Filter

 Setting the Average Filter p.91

As an example, here is an explanation of the procedure for selecting the "128" average count setting.

Operating procedure











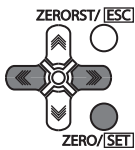



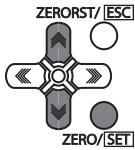

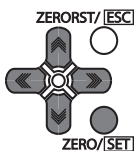

Steps	Key operation	Display	Description
1 to 4			For moving to "FILTER", see steps 1 to 4 on p.236.
5			Select "AVE" as the filter type. Press the  /  keys to select "AVE" and press the  key.
6			Select the average count. The current setting value is displayed on the sub-display. Press  /  key to enter editing mode and the sub-display blinks. In this example, select "128" and press the  key.
7			Press the  key for two seconds to enter the RUN mode.

Setting the Frequency Filter

 Setting the Frequency Filter p.92

As an example, here is an explanation of the procedure for selecting the "LOPASS" setting for the frequency filter type, and the "1Hz" cut-off frequency filter setting.

Operating procedure











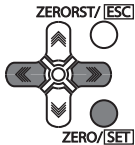



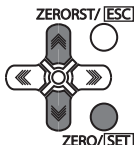





Steps	Key operation	Display	Description
1 to 4			For moving to "FILTER", see steps 1 to 4 in p.236.
5			Select "FRQNCY" as the filter type. Press the  /  keys to select "FREQ" and press the  key.
6			Select the frequency filter type. LO.PASS: LOWPASS FILTER HIPASS: HIGHPASS FILTER BD.PASS: BANDPASS FILTER Select "LOPASS" as the frequency filter type. The current setting value is displayed on the sub-display. Press  /  key to enter editing mode and the sub-display blinks. In this example, select "LO.PASS" and press the  key.
7			Set the cut-off frequency. "CUTOFF" is displayed on the main display and the current setting value is displayed on the sub-display. Press  key to enter the editing mode, and the sub-display blinks. To edit numerical values, use the  /  /  /  keys. In this example, input "1", then press the  key.
8			Press the  key for two seconds to enter the RUN mode.

Setting the Differentiation Filter

 Setting the Differentiation Filter p.93

As an example, here is an explanation of the procedure for selecting the "10ms" number of differential cycles.

Operating procedure

Steps	Key operation	Display	Description
1 to 4			For moving to "FILTER", see steps 1 to 4 in p.236.
5			Select "DIFFER" as the filter type. Press the  /  keys to select "DIFFER" and press the  key.
6			Enable the differentiation filter. The current setting value is displayed on the sub-display. Press  /  key to enter editing mode and the sub-display blinks. Select "ON", then press the  key.
7			Set the number of differential cycles. "CYCLE" is displayed on the main display and the current setting value is displayed on the sub-display. Press  key to enter the editing mode, and the sub-display blinks. To edit numerical values, use the  /  /  /  keys. In this example, input "10", then press the  key.
8			Press the  key for two seconds to enter the RUN mode.























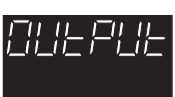







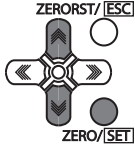



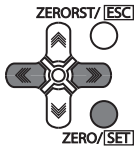

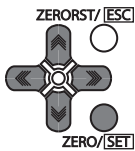

Setting Scaling

Performing Manual Scaling

 Performing Manual Scaling p.83

As an example, here is an explanation of the procedure for setting the manual scaling type to "SPAN" and the inclination coefficient to "1.2".

Operating procedure











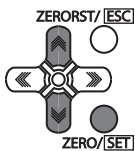



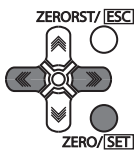





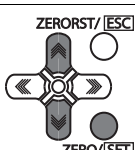
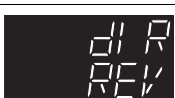

Steps	Key operation	Display	Description
1			Press the  key for two seconds to enter the FUN mode.
2			Press the  /  keys to select "MEAS" and press the  key.
3			Press the  /  keys to select "TASK 1" and press the  key.
4			Press the  /  keys to select "OUTPUT" and press the  key.
5			Press the  /  keys to select "SCALE" and press the  key.
6			Select "MANUAL" as the scaling type. The current setting value is displayed on the sub-display. Press the  /  keys to enter the editing mode, and the sub-display blinks. Select "MANUAL" and press the  key.
7			Set the manual scaling type. SPAN: Span OFFSET: Offset In this example, press the  /  keys, select "SPAN" and press the  key.
8			Set the inclination coefficient. The current setting value is displayed on the sub-display. Press the  key to enter the editing mode, and the sub-display blinks. To edit numerical values, use the  /  /  /  keys. In this example, select "1.2" and press the  key.
9			Press the  key for two seconds to enter the RUN mode.

Automatically Setting Scaling

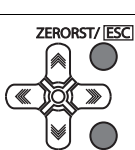
Performing 1-point Scaling

 Performing 1-point Scaling p.84











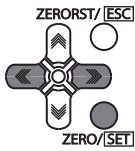







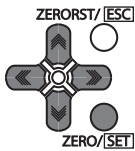









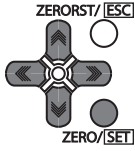

Operating procedure

Steps	Key operation	Display	Description
1 to 5			For moving to "SCALE", see steps 1 to 5 in p.240.
6			Select "AUTO" as the scaling type. The current setting value is displayed on the sub-display. Press  key to enter editing mode and the sub-display blinks. Select "AUTO" and press the  key.
7			Select "1POINT". Press the  keys to select "1PT" and press the  key.
8			Press the  key when the main display shows "POINT1".
9			The current measured value is displayed on the main display and the current setting value is displayed on the sub-display. To edit numerical values, use the  keys. Enter the setting value and then press the  key.
10			Set the increment/decrement direction. "DIRECT" is displayed on the main display and the incremental/decremental directions ("FWD": the NEAR side as + and "REV": the FAR side as +) are displayed on the sub-display. Press  key to enter editing mode and the sub-display blinks. Enter the setting value and then press the  key.
11			"OK/CAN" is displayed on the sub-display. Press the  key to execute scaling or  key to cancel.
12			Press the  key for two seconds to enter the RUN mode.

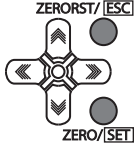
Performing 2-point Scaling

 Performing 2-point Scaling p.86











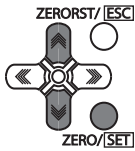



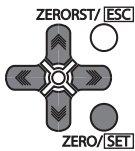



Operating procedure

Steps	Key operation	Display	Description
1 to 6			For moving to "SCALE" - "AUTO", see steps 1 to 6 in p.240.
7			Press the  /  keys to select "2PT" and press the  key.
8			Press the  key when the main display shows "POINT1".
9			Set the measured value of point 1. The current measured value is displayed on the main display and the current setting value is displayed on the sub-display. To edit numerical values, use the  /  /  /  keys. Enter the setting value and then press the  key.
10			Press the  key when the main display shows "POINT2".
11			Set the measured value of point 2. To edit numerical values, use the  /  /  /  keys. Enter the setting value and then press the  key.
12			"OK/CAN" is displayed on the sub-display. Press the  key to execute scaling or  key to cancel.
13			Press the  key for two seconds to enter the RUN mode.

Performing Thickness Scaling

 Performing Thickness Scaling p.88

Operating procedure

Steps	Key operation	Display	Description
1 to 5			For moving to "SCALE", see steps 1 to 5 in p.240.
6			<p>Select "THICK" as the scaling type. The current setting value is displayed on the sub-display.</p> <p>Press / key to enter editing mode and the sub-display blinks. Select "THICK" and press the  key.</p>
7			<p>The current measured value is displayed on the main display and the current setting value is displayed on the sub-display.</p> <p>Press  key to enter the editing mode, and the sub-display blinks.</p> <p>To edit numerical values, use the /// keys. Enter the setting value and then press the  key.</p>
8			<p>"OK/CAN" is displayed on the sub-display.</p> <p>Press the  key to execute scaling or  key to cancel.</p>
9			<p>Press the  key for two seconds to enter the RUN mode.</p>











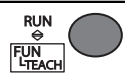
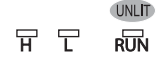

















Setting Hold

Setting the Hold Mode

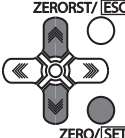
 Setting the Hold Mode p.94

As an example, here is an explanation of the procedure for selecting the "PEAK" hold mode setting.

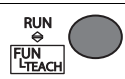
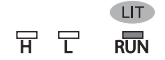
Operating procedure











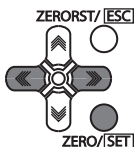

Steps	Key operation	Display	Description
1			Press and hold the  key for two seconds to enter the FUN mode.
2			Press the  key to select MEAS, then press the  key.
3			Press the  key to select TASK1, then press the  key.
4			Press the  key to select "OUTPUT" and press the  key.
5			Press the  key to select "HOLD" and press the  key.
6			Press the  key to select "TYPE" and press the  key.
7			Set the hold mode. PEAK: Peak BOTTOM: Bottom P-P: PEAK TO PEAK AUTOPEAK: AUTO PEAK AUTOBT: AUTO BOTTOM AUTOPEAK TO PEAK AVE: AVERAGE SAMPLE: Sampling OFF: Through The current setting value is displayed on the sub-display. Press  key to enter editing mode and the sub-display blinks. In this example, select "PEAK" and press the  key.
8			Press the  key for two seconds to enter the RUN mode.

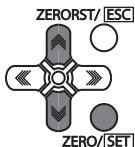
Setting Triggers

 Setting Triggers p.97

As an example, here is an explanation of the procedure for selecting the "TIMING" trigger type setting.

Operating procedure

Steps	Key operation	Display	Description
1 to 5			For moving to "HOLD", see steps 1 to 5 in p.244.
6			Press the  /  keys to select "TRIG" and press the  key.
7			Set the trigger method. TIMING: External SELF-U: SELF-UP SELF-D: SELF-DOWN "TYPE" is displayed on the main display and the current setting value is displayed on the sub-display. Press  /  key to enter editing mode and the sub-display blinks. In this example, select "TIMING" and press the  key.
8			Press the  key for two seconds to enter the RUN mode.

Performing Hold with a Key Input

Press the / key on the Sensor Controller to enable the TIMING or RESET input.

- TIMING input is ON while the key is pressed.
- RESET input is ON when the key is pressed.

Note that the key input is disabled in the default setting. Set the following when using this function.

Steps	Key operation	Display	Description
1			Press and hold the key for two seconds to enter the FUN mode.
2			Press the / keys to select "SYSTEM" and press the .
3			Press the / keys to select "KEY.IN" and press the .
4			Enable the key input. The current setting value is displayed on the sub-display. Press / key to enter editing mode and the sub-display blinks. Select "ON" and press the .
5			Press the key for two seconds to enter the RUN mode.

Note















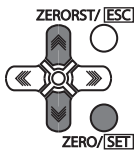





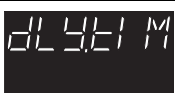













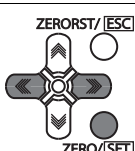

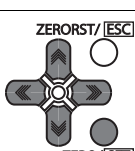

The above settings are also possible using the personal computer tools.

Performing Hold with a Key Input p.99

Setting a Trigger Delay

 Setting a Trigger Delay p.100

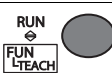
Operating procedure

Steps	Key operation	Display	Description
1 to 5			For moving to "HOLD", see steps 1 to 5 in p.244.
6			Press the  /  keys to select "DELAY" and press the  key.
7			Enable the delay. "DELAY" is displayed on the main display and the current setting value is displayed on the sub-display. Press  /  key to enter editing mode and the sub-display blinks. Select "ON" and press the  key.
8			Select the delay time. Press the  /  keys to select "DLY.TIM" and press the  key.
9			Set the delay time. The current setting value is displayed on the sub-display. Press  key to enter the editing mode, and the sub-display blinks. To edit numerical values, use the  /  /  /  keys. In this example, input "10", then press the  key.
10			Press the key to return to the previous menu.
11			Select the sampling time. Press the  /  keys to select "SMP.TIM" and press the  key.
12			Set the sampling time. The current setting value is displayed on the sub-display. Press  key to enter the editing mode, and the sub-display blinks. To edit numerical values, use the  /  /  /  keys. In this example, input "10", then press the  key.
13			Press the  key for two seconds to enter the RUN mode.













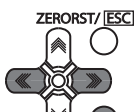













Setting the Zero Reset

Setting the Status

 Setting the Status p.101

As an example, here is an explanation of the procedure for selecting the "ON" (Enabled) zero reset type setting.

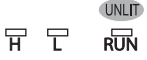
Operating procedure















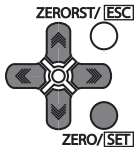
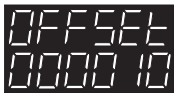



Steps	Key operation	Display	Description
1			Press and hold the  key for two seconds to enter the FUN mode.
2			Press the  key to select MEAS, then press the  key.
3			Press the  key to select TASK1, then press the  key.
4			Press the  key to select "OUTPUT" and press the  key.
5			Press the  key to select "ZERO" and press the  key.
6			Press the  key to select "STATUS" and press the  key.
7			Set zero reset ON/OFF. The current setting value is displayed on the sub-display. Press  key to enter editing mode and the sub-display blinks. In this example, select "ON" and press the  key.
8			Press the  key for two seconds to enter the RUN mode.

Setting the Offset

 Setting the Offset p.102

As an example, here is an explanation of the procedure for selecting the "10 mm" reference value setting.

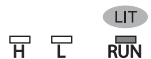
Operating procedure













Steps	Key operation	Display	Description
1 to 5			For moving to "ZERO", see steps 1 to 5 in p.248.
6			Press the  /  keys to select "OFFSET" and press the  key.
7			Change the offset value. The current setting value is displayed on the sub-display. Press  key to enter the editing mode, and the sub-display blinks. To edit numerical values, use the  /  /  /  keys. In this example, input "10", then press the  key.
8			The decimal point is displayed. Press the  /  key to move the decimal point. Determine the decimal point and then press the  key.
9			Press the  key for two seconds to enter the RUN mode.

Setting the Zero Reset Mode

 Setting the Zero Reset Type p.103

As an example, here is an explanation of the procedure for selecting the "REAL" zero reset type setting.

Operating procedure











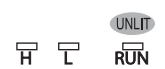





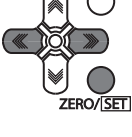

Steps	Key operation	Display	Description
1 to 5			For moving to "ZERO", see steps 1 to 5 in p.248.
6			Press the  /  keys to select "TYPE" and press the  key.
7			Select the zero reset mode. REAL: Real HOLD: Hold Select "REAL" as the zero reset type. The current setting value is displayed on the sub-display. Press  /  key to enter editing mode and the sub-display blinks. In this example, select "REAL" and press the  key.
8			Press the  key for two seconds to enter the RUN mode.

Setting the Zero Reset Memory

 Setting the Zero Reset Memory p.104

As an example, here is an explanation of the procedure for selecting the "ON" (enabled) zero reset memory setting.

Operating procedure

Steps	Key operation	Display	Description
1			Press and hold the  key for two seconds to enter the FUN mode.
2			Press the  /  keys to select "SYSTEM" and press the  key.
3			Press the  /  keys to select "ZER.MEM" and press the  key.
4			Select zero reset memory ON/OFF. The current setting value is displayed on the sub-display. Press  /  key to enter editing mode and the sub-display blinks. In this example, select "ON" and press the  key.
5			Press the  key for two seconds to enter the RUN mode.













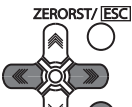





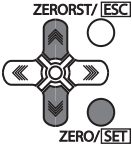

9-9 Setting the Banks

Switching Banks

 Switching Banks p.60

As an example, here is an explanation of the procedure for setting BANK2.

Operating procedure











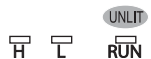

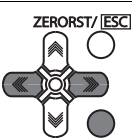



Steps	Key operation	Display	Description
1			 Press and hold the key for two seconds to enter the FUN mode.
2			Press the  /  key to select BANK, then press the  key.
3			Press the  /  key to select BK.CHG, then press the  key.
4			Select BANK2 for the bank number. The current setting value is displayed on the sub-display. Press  /  key to enter editing mode and the sub-display blinks. Select "BANK2" and press the  key.
5			 Press and hold the key for two seconds to enter the RUN mode.

Changing the Bank Mode

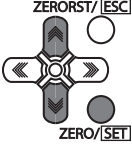
 Changing the Bank Mode p.106

As an example, here is an explanation of the procedure for selecting the "NORMAL" bank mode setting.

Operating procedure

Steps	Key operation	Display	Description
1			Press and hold the  key for two seconds to enter the FUN mode.
2			Press the  key to select BANK, then press the  key.
3			Press the  keys to select "BK.MODE" and press the  key.
4			Select the bank data. NORMAL: NORMAL JUDGE: JUDGEMENT The current setting value is displayed on the sub-display. Press  key to enter editing mode and the sub-display blinks. In this example, select "NORMAL" and press the  key.
5			Press the  key for two seconds to enter the RUN mode.











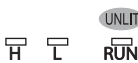









Copying the Bank Settings

Copy the selected bank setting to another bank.

 Copying the Bank/System Settings p.107

As an example, here is an explanation of the procedure for copying the BANK1 setting to BANK4.

Operating procedure

Steps	Key operation	Display	Description
1			Press and hold the  key for two seconds to enter the FUN mode.
2			Press the  key to select BANK, then press the  key.
3			Press the  keys to select "BK.COPY" and press the  key.
4			Select "BANK1" as the bank setting to be copied. "FROM" is displayed on the main display and the current setting value is displayed on the sub-display. Press  key to enter editing mode and the sub-display blinks. Select "BANK1" and press the  key.
5			Select "BANK4" as the target to copy the bank setting. "TO" is displayed on the main display and the current setting value is displayed on the sub-display. Press the  keys to enter the editing mode, and the sub-display blinks. Select "BANK4" and press the  key.
6			Press the  key for two seconds to enter the RUN mode.

Saving the Bank/System Settings





















Save the bank/system settings to the Sensor Controller.

Important

- The settings of all banks are saved regardless of the currently selected bank number.
- After you have made or changed settings, be sure to save the setup data. All settings will be deleted if you turn the power OFF without saving the data.

Here is an explanation of the procedure for saving the bank/system settings.

Operating procedure

Steps	Key operation	Display	Description
1			Press and hold the  key for two seconds to enter the FUN mode.
2			Press the  /  keys to select "SYSTEM" and press the  key.
3			Press the  /  keys to select "SAVE" and press the  key.
4			"OK/CAN" is displayed on the sub-display. Press the  key to save the settings or the  key to cancel.
5			Press the  key for two seconds to enter the RUN mode.

Clearing the Bank Settings











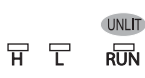

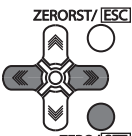

Clear (initialize) the setting of the currently selected bank.

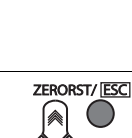
 Clearing the Bank Settings p.109

Important

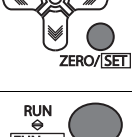
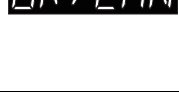
Operations on the Sensor Controller do not initialize system settings and settings displayed in RUN mode.

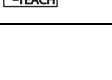
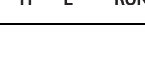

Operating procedure

Steps	Key operation	Display	Description
1			Press and hold the  key for two seconds to enter the FUN mode.
2			Press the  /  key to select BANK, then press the  key.
3			Press the  /  keys to select "BK.CLR" and press the  key.
4			"OK/CAN" is displayed on the sub-display. Press the  key to clear the settings or the  key to cancel.
5			Press the  key for two seconds to enter the RUN mode.

9-10 Setting Threshold Value

 3-6 Setting Threshold Value p.64

There are two ways of setting the threshold value.

Method	Operating key	Description
TEACHING		Perform the measurement and set the result as the threshold value. This is a convenient way when the upper or lower limit sample is available.
Direct		Set the threshold value by entering the numerical values directly. This is a convenient way when you know the dimensions of a quality product or when adjusting the threshold value set by teaching.





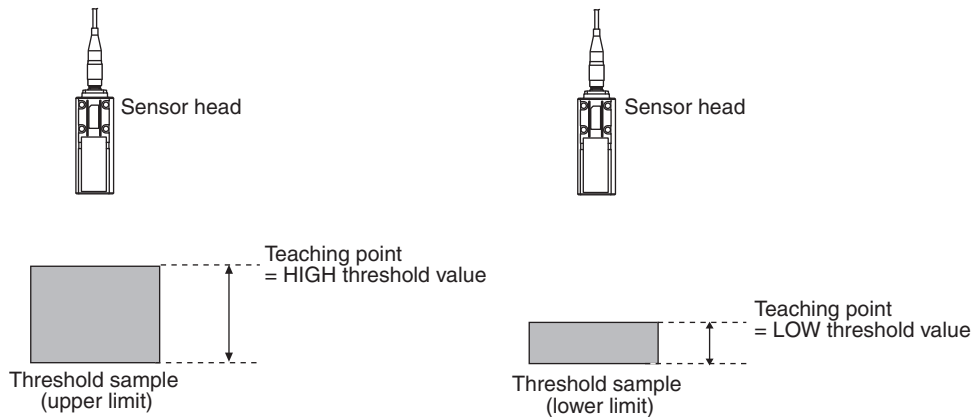







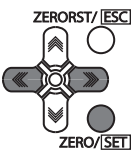











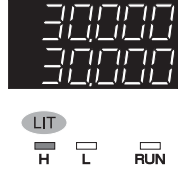

Teaching

Perform the measurement and set the result as the threshold value.



The existing settings for hold, trigger, and scaling are also reflected in the measurement during teaching.

As an example, here is an explanation of the procedure for setting the current measured value as a HIGH threshold value.



















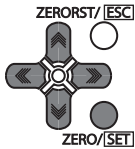
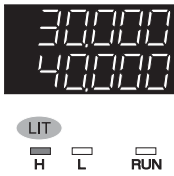

Steps	Key operation	Display	Description
1			Press and hold the  key for two seconds to enter the FUN mode.
2			Press the  key to select MEAS, then press the  key.
3			Press the  key to select TASK1, then press the  key.
4			Press the  key to select JUDGE, then press the  key.
5			Press the  key to select TEACH, then press the  key.
6			Select HIGH THRESHHOLD as the threshold value type. Press the  key to select H.JUDGE, then press the  key.
7			The current measured value is displayed on the main display and the current set threshold value is displayed on the sub-display. (At this time, the THRESHOLD-H indicator lights up.) Press the  key to display the current measured value on the lower line in the main display.
8			Press the  key to start a teaching. The indicator for the current measured value on the main display lights up, applying the value as a threshold value.
9			Press and hold the  key for two seconds to enter the RUN mode.

Direct

Set the threshold value by entering the numerical values directly.

As an example, here is an explanation of the procedure for setting a HIGH threshold value by entering "40.000" directly.

Operating procedure

Steps	Key operation	Display	Description
1 to 4			For moving to JUDGE, see steps 1 to 4 on p.258.
5			Press the  /  key to select DIRECT, then press the  key.
6			Select HIGH THRESHOLD as the threshold value type. Press the  /  key to select H.JUDGE, then press the  key.
7			Set "40.000" as the HIGH threshold value. The current measured value is displayed on the main display and the current set threshold value is displayed on the sub-display. (At this time, the THRESHOLD-H indicator lights up.) Press  key to enter the editing mode, and the sub-display blinks. To edit numerical values, use the  /  /  /  keys. Enter "40.000" and press the  key.
8			Press and hold the  key for two seconds to enter the RUN mode.

9-11 Setting the System

Display/set the system environment.













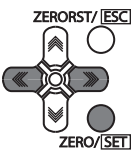











Checking Information

Display the set measuring cycle and information of the Sensor Controller and Sensor Head.

 Checking Information p.110

As an example, here is an explanation of the procedure for displaying the serial No. of the Sensor Head.

Operating procedure

Steps	Key operation	Display	Description
1			Press and hold the  key for two seconds to enter the FUN mode.
2			Press the  /  keys to select "SYSTEM" and press the  key.
3			Select the information to display. CYCLE: Currently set measurement cycle [ms] C.INFO: CONTROLLER INFORMATION H.INFO: SENSOR HEAD INFORMATION In this example, press the  /  keys, select "H.INFO" and press the  key.
4			When the Controller information and Sensor Head information have been changed, select the additional information to display: VER: Controller version information MAC.ADR: Controller MAC address MODEL: Sensor Head model information SER.NO: Sensor Head serial No. In this example, press the  /  keys, select "SER.NO" and press the  key.
5	-		"SER.1" is displayed on the main display and the higher-order digit of the serial No. is displayed on the sub-display.
6			When the  /  key is pressed, "SER.2" is displayed on the main display and the lower-order digit of the serial No. is displayed on the sub-display.
7			Press the  key for two seconds to enter the RUN mode.

Setting the Key Lock



















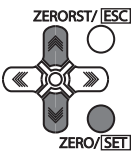

 Setting the Key Lock p.111

Important

Note that, moving to the key lock setting menu or moving between menu hierarchies are possible even when the key lock function is ON.

Here is an explanation of the procedure for turning the key lock ON.











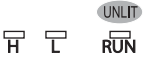







Operating procedure

Steps	Key operation	Display	Description
1			Press and hold the  key for two seconds to enter the FUN mode.
2			Press the  /  keys to select "SYSTEM" and press the  key.
3			Press the  /  keys to select "LOCK" and press the  key.
4			Select key lock ON/OFF. The current setting value is displayed on the sub-display. Press the  /  keys to enter the editing mode, and the sub-display blinks. In this example, select "ON" and press the  key.
5			Press the  key for two seconds to enter the RUN mode.

Calibrating Sensor Head

 Calibrating Sensor Head p.38

Operating procedure

Steps	Key operation	Display	Description
1			Press and hold the  key for two seconds to enter the FUN mode. (For details on the functions of the Mode switching key, see p.220.)
2			Press the  /  keys to select "SYSTEM" and press the  key.
3			Press the  /  keys to select "H.CALIB", then press the  key.
4			"OK/CAN" is displayed on the sub-display. Press the  key to execute calibration or the  key to cancel.
5			Press the  key for two seconds to enter the RUN mode.



















Important When Sensor Head calibration fails

If the Sensor Head is calibrated in an inappropriate environment, an error is displayed on the main display. If this happens, press the  key to return to the previous screen and try again. If an error continues even after calibrating the Sensor Head in an appropriate environment, the fiber connector on the Sensor Head or Sensor Controller may be stained. Clean the fiber cable or fiber connector referring to p.35.

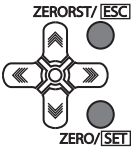
Initializing Settings

 Initializing Settings p.112

Operating procedure

Steps	Key operation	Display	Description
1			Press and hold the  key for two seconds to enter the FUN mode.
2			Press the  /  keys to select "SYSTEM" and press the  key.
3			Press the  /  keys to select "INIT" and press the  key.
4			"OK/CAN" is displayed on the sub-display. Press the  key to restore the default values, or  key to cancel.
5			Press the  key for two seconds to enter the RUN mode.

9-12 Connecting Parallel I/O























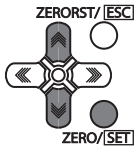

Settings for Analog Output

Setting the analog output destination

 Setting the analog output destination p.138

As an example, here is an explanation of the procedure for outputting the voltage.

Operating procedure











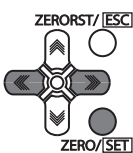

Steps	Key operation	Display	Description
1			Press and hold the  key for two seconds to enter the FUN mode.
2			Press the  /  keys to select "I/O" and press the  key.
3			Press the  /  keys to select "ANALOG" and press the  key.
4			Press the  /  keys to select "V OR C" and press the  key.
5			Select the output destination. VOLT: Voltage CUR: Current The current setting value is displayed on the sub-display. Press  /  key to enter editing mode and the sub-display blinks. In this example, select "VOLT" and press the  key.
6			Press the  key for two seconds to enter the RUN mode.

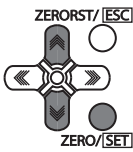
Assigning Analog Output

 Assigning Analog Output p.139

As an example, here is an explanation of the procedure for outputting the results of TASK1 as analog.

Operating procedure





Steps	Key operation	Display	Description
1 to 3			For moving to "ANALOG", see steps 1 to 3 in p.264.
2			Press the  /  keys to select "OUTPUT" and press the  key.
3			Select the task to output. TASK1 to TASK4/OFF The current setting value is displayed on the sub-display. Press  /  key to enter editing mode and the sub-display blinks. In this example, select "TASK1" and press the  key.
4			Press the   key for two seconds to enter the RUN mode.





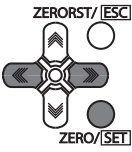





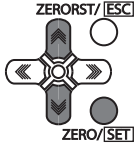









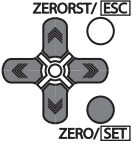











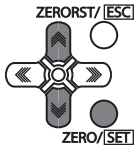



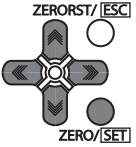







Setting Monitor Focus

 Setting Monitor Focus p.140

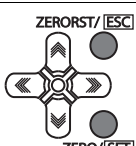
The following describes the procedure when setting 4 mA output (Point1) for measured value of 0 mm and 20 mA output for measured value of 6mm (Point2).

Operating procedure

Steps	Key operation	Display	Description
1 to 3			For moving to "ANALOG", see steps 1 to 3 in p.264.
4			Press the  /  keys to select "FOCUS" and press the  key.















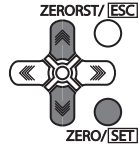



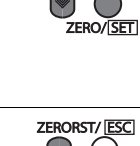



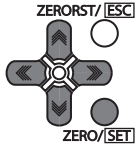







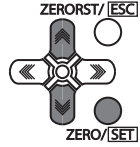



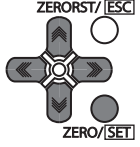



Steps	Key operation	Display	Description
5			Select monitor focus ON/OFF. The current setting value is displayed on the sub-display. Press  /  key to enter editing mode and the sub-display blinks. In this example, select "ON" and press the  key.
6			Set the distance value of the 1st point. The current setting value is displayed on the sub-display. Press  /  key to enter editing mode and the sub-display blinks. In this example, select "4mA" and press the  key.
7			Set the output value of the 1st point. The current setting value is displayed on the sub-display. Press  key to enter the editing mode, and the sub-display blinks. To edit numerical values, use the  /  /  /  keys. In this example, input "0", then press the  key.
8			The decimal point is displayed. Press the  /  key to move the decimal point. Determine the decimal point and then press the  key.
9			Set the distance value of the 2nd point. The current setting value is displayed on the sub-display. Press  /  key to enter editing mode and the sub-display blinks. In this example, select "20mA" and press the  key.
10			Set the output value of the 2nd point. The current setting value is displayed on the sub-display. Press  key to enter the editing mode, and the sub-display blinks. To edit numerical values, use the  /  /  /  keys. In this example, input "6", then press the  key.
11			The decimal point is displayed. Press the  /  key to move the decimal point. Determine the decimal point and then press the  key.
12			"OK/CAN" is displayed on the sub-display. Press the  key to reflect the settings or the  key to cancel.
13			Press the  key for two seconds to enter the RUN mode.

Adjusting the analog output value

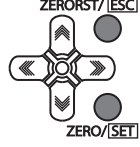
 Adjusting the analog output value p.141

As an example, the following explains the procedure for correcting 4 mA output (Point1) and 20 mA output (Point2).

Operating procedure

Steps	Key operation	Display	Description
1 to 3			For moving to "ANALOG", see steps 1 to 3 in p.264.
4			Press the  /  keys to select "CALIB" and press the  key.
5			Select analog output correction ON/OFF. The current setting value is displayed on the sub-display. Press  /  key to enter editing mode and the sub-display blinks. In this example, select "ON" and press the  key.
6			Set the reference value of the point1. The current set value for the point1 is displayed on the sub-display. Press  /  key to enter editing mode and the sub-display blinks. In this example, select "4mA" and press the  key.
7			Set the adjustment value of the point1. Press the  /  /  /  keys to input the adjustment value and press the  key. Next, check the ammeter value and press the  key. To re-adjust, press the  key.
8			Set the reference value of the point2. The current set value for the point2 is displayed on the sub-display. Press  /  key to enter editing mode and the sub-display blinks. In this example, select "20mA" and press the  key.
9			Set the adjustment value of the point2. Press the  /  /  /  keys to input the adjustment value and press the  key. Next, check the ammeter value and press the  key. To re-adjust, press the  key.
10			"OK/CAN" is displayed on the sub-display. Press the  key to execute correction or  key to cancel.
11			Press and hold the  key for two seconds to enter the RUN mode.













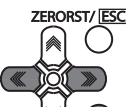













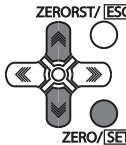



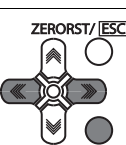

Settings for Binary Output

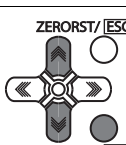
Output Content Setting

 Output content setting p.146

As an example, here is an explanation of the procedure for outputting the measured value of TASK1 as binary for each measuring cycle.

Operating procedure











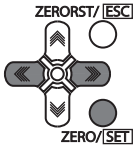

Steps	Key operation	Display	Description
1			Press and hold the  key for two seconds to enter the FUN mode.
2			Press the  /  keys to select "I/O" and press the  key.
3			Press the  /  keys to select "BINARY" and press the  key.
4			Press the  /  keys to select "OUTPUT" and press the  key.
5			Select the binary output contents. The current set value is displayed on the sub-display. Press  /  key to enter editing mode and the sub-display blinks. In this example, select "MEAS1" and press the  key.
6			Press the  /  keys to select "TASK1" and press the  key.
7			Enable TASK1 binary output. The current set value is displayed on the sub-display. Press  /  key to enter editing mode and the sub-display blinks. Select "ON" and press the  key.
8			Press and hold the  key for two seconds to enter the RUN mode.

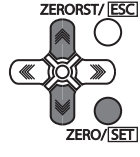
Decimal Point Digit Setting

 Decimal point digit setting p.147

As an example, here is an explanation of the procedure for setting the number of digits after the decimal point to "3".

Operating procedure













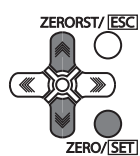

Steps	Key operation	Display	Description
1 to 3			For moving to "BINARY", see steps 1 to 3 in p.264.
4			Press the  /  keys to select "DEC.NUM" and press the  key.
5			Select the number of digits after the decimal point. The current set value is displayed on the sub-display. Press  /  key to enter editing mode and the sub-display blinks. In this example, select "3DIG" and press the  key.
6			Press and hold the  key for two seconds to enter the RUN mode.

Output cycle setting

 Output cycle setting p.148

As an example, here is an explanation of the procedure for setting the output cycle to "2 times" the measurement cycle.

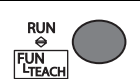
Operating procedure

Steps	Key operation	Display	Description
1 to 3			For moving to "BINARY", see steps 1 to 3 in p.264.
4			Press the  /  keys to select "CYCLE" and press the  key.
5			Set the output cycle. The current setting value is displayed on the sub-display. Press  key to enter the editing mode, and the sub-display blinks. To edit numerical values, use the  ,  ,  ,  keys. In this example, input "2", then press the  key.
6			Press and hold the  key for two seconds to enter the RUN mode.

Note

The measuring cycle can be viewed in the "System Information" menu.





 Checking Information p.260







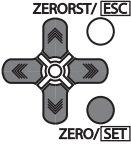

GATE signal setting

 GATE signal setting p.149

As an example, here is an explanation of the procedure for setting the output time to "100 ms".

Operating procedure

Steps	Key operation	Display	Description
1 to 3			For moving to "BINARY", see steps 1 to 3 in p.264.
4			Press the  /  keys to select "GATE" and press the  key.

Steps	Key operation	Display	Description
5			Set the output time. The current setting value is displayed on the sub-display. Press  key to enter the editing mode, and the sub-display blinks. To edit numerical values, use the  keys. In this example, input "100", then press the  key.
6			Press and hold the  key for two seconds to enter the RUN mode.





















Settings for Judgment Output

Assigning judgment output

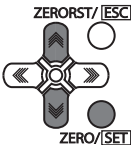
 Assigning judgment output p.143

As an example, the following explains the procedure for outputting the judgment results for TASK1.

Operating procedure











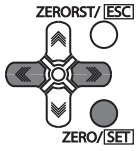



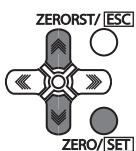

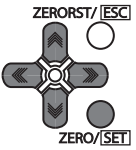
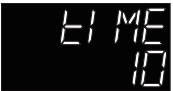

Steps	Key operation	Display	Description
1			Press and hold the  key for two seconds to enter the FUN mode.
2			Press the  keys to select "I/O" and press the  key.
3			Press the  keys to select "JUDGE" and press the  key.
4			Press the  keys to select "OUTPUT" and press the  key.
5			Select the task for which to output the judgment result. The current setting value is displayed on the sub-display. Press  key to enter editing mode and the sub-display blinks. In this example, select "TASK1" and press the  key.
6			Press the  key for two seconds to enter the RUN mode.

Setting Operation at Judgment Output

 Setting Operation at Judgment Output p.144

As an example, the following explains the procedure for setting the timer type to "1 SHOT" and the timer duration to "10ms".

Operating procedure

Steps	Key operation	Display	Description
1 to 3			For moving to "JUDGE", see steps 1 to 3 in p.271.
4			Select the judgment output setting item. HYS: Hysteresis width TIMER: Timer mode In this example, press the  /  keys, select "TIMER" and press the  key.
5			Select the timer mode. OFF: Not set OFF.DLY: Off Delay ONDLY: On Delay 1SHOT: One Shot Select "1SHOT" as the judgment output type. The current setting value is displayed on the sub-display. Press the  /  keys to enter the editing mode, and the sub-display blinks. Select "1SHOT" and press the  key.
6			Set the timer duration. The current setting value is displayed on the sub-display. Press  key to enter the editing mode, and the sub-display blinks. To edit numerical values, use the  /  /  /  keys. In this example, input "10", then press the  key.
7			Press and hold the  key for two seconds to enter the RUN mode.















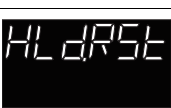

Settings for Processing When Measurement Is Not Possible

Setting operation when measurement is not possible

 Setting operation when measurement is not possible p.150

As an example, the following explains the procedure for setting processing for when measurement is not possible to "CLAMP".

Operating procedure











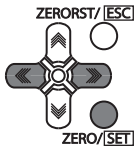

Steps	Key operation	Display	Description
1			Press and hold the  key for two seconds to enter the FUN mode.
2			Press the  /  keys to select "I/O" and press the  key.
3			Press the  /  keys to select "HLD.RST" and press the  key.
4			Select the operation when measurement is not possible. KEEP: KEEP CLAMP: CLAMP The current setting value is displayed on the sub-display. Press  /  key to enter editing mode and the sub-display blinks. In this example, select "CLAMP" and press the  key.

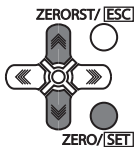
Setting the Clamp Value

 Setting the Clamp Value for Analog Output p.151

As an example, the following explains the procedure for setting the clamp value to "analog voltage output 10V".

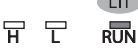
Operating procedure

Steps	Key operation	Display	Description
1 to 4			For moving to "HLD.RST" - "CLAMP", see steps 1 to 4 in p.273.
2			Press the  /  keys to select "ANALOG" and press the  key.
6			Set the clamp value. The current setting value is displayed on the sub-display. Press  /  key to enter editing mode and the sub-display blinks. Select "10V" and press the  key.
7			Press the  key for two seconds to enter the RUN mode.











































Setting for Internal Logging

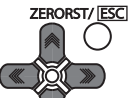

Setting LOGGING save count and LOGGING save intervals

 Settings for Internal Logging p.154

As an example, here is an explanation of the procedure for setting save intervals to "1" and save count to "100".

Operating procedure

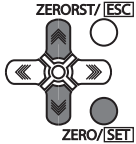
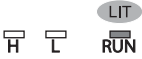
Steps	Key operation	Display	Description
1			Press and hold the  key for two seconds to enter the FUN mode.
2			Press the  /  keys to select "I/O" and press the  key.
3			Press the  /  keys to select "PAR.LOG" and press the  key.
4			Select the save intervals. Press the  /  keys to select "INTRVL" and press the  key.
5			Set the save intervals. The current setting value is displayed on the sub-display. Press  key to enter the editing mode, and the sub-display blinks. To edit numerical values, use the  /  /  /  keys. In this example, input "1", then press the  key.
6			Press the  key to return to the previous menu.
7			Select the save count. Press the  /  keys to select "COUNT" and press the  key.
8			Set the save count. The current setting value is displayed on the sub-display. Press  key to enter the editing mode, and the sub-display blinks. To edit numerical values, use the  /  /  /  keys. In this example, input "100", then press the  key.











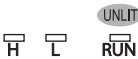

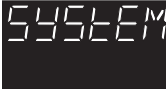









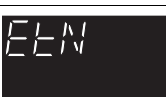







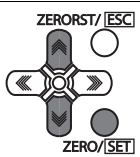



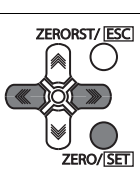

Steps	Key operation	Display	Description
9			Press the  key for two seconds to enter the RUN mode.

9-13 Connecting by No-protocol Communications

Initial Settings for No-protocol Communications

 Initial Settings for No-protocol Communications p.171

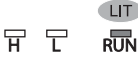



















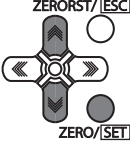



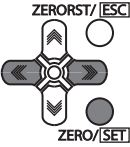

Operating procedure

Steps	Key operation	Display	Description
1			Press and hold the  key for two seconds to enter the FUN mode.
2			Press the  /  keys to select "SYSTEM" and press the  key.
3			Press the  /  keys to select "COM" and press the  key.
4			Press the  /  keys to select "ETN" and press the  key.
5			Select the setting item: IPADDR: IP address SUBNET: Subnet mask PROTCL: Protocol OUTIP: Output IP address PORT.IN: Port number PORT.OT: Output destination port number In this example, press the  /  keys, select "PROTCL" and press the  key.
6			Selects the protocol. The current setting value is displayed on the sub-display. Press  /  key to enter editing mode and the sub-display blinks. Select "TCP.SV" and press the  key.
7			Press the  key to return to the previous menu.
8			Press the  /  keys to select "OUTIP" and press the  key.
9	Repeat steps 6 to 8 to set other items.		
10			Press and hold the  key for two seconds to enter the RUN mode.

Setting Communications Specifications (RS-232C Communications)

 Setting Communications Specifications (RS-232C Communications) p.173

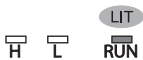









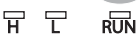











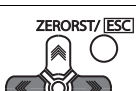









Operating procedure

Steps	Key operation	Display	Description
1 to 3	For moving to "COM", see steps 1 to 3 in p.277.		
4			Press the  /  keys to select "RS232C" and press the  key.
5			Select the setting item: BAUD.RT: baud rate DATA: data length PARITY: parity STOP: stop bit CS/RS: CS/RS control In this example, press the  /  keys, select "DATA" and press the  key.
6			Selects the data length. The current setting value is displayed on the sub-display. Press  /  key to enter editing mode and the sub-display blinks. Select the data length, and press the  key.
7			Press the  key to return to the previous menu.
8			Press the  /  keys to select "PARITY" and press the  key.
9	Repeat steps 6 to 8 to set other items.		
10			Press and hold the  key for two seconds to enter the RUN mode.

Setting Serial Data Output

 Setting the data output destination p.174

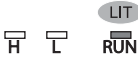









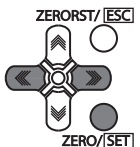

Operating procedure

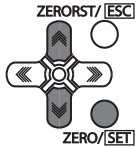
Steps	Key operation	Display	Description
1			Press and hold the  key for two seconds to enter the FUN mode.
2			Press the  /  keys to select "I/O" and press the  key.
3			Press the  /  keys to select "COM.OUT" and press the  key.
4			Select the setting item: OUTPUT: Data output destination FORMAT: Output data type INT.NUM: Digits of integer DEC.NUM: Digits of decimal ZEROSP: Zero suppression FIELD: Field separator RECORD: Record separator In this example, press the  /  keys, select "OUTPUT" and press the  key.
5			Automatically Following the Range of Measurement Area2 The current setting value is displayed on the sub-display. Press  /  key to enter editing mode and the sub-display blinks. Select the data length, and press the  key.
6			Press the  key to return to the previous menu.
7			Select the save count. Press the  /  keys to select "FORMAT" and press the  key.
8	Repeat steps 5 to 7 to set other items.		
9			Press and hold the  key for two seconds to enter the RUN mode.

Set the delimiter

 Setting Communications Specifications (RS-232C Communications) p.173

Operating procedure

Steps	Key operation	Display	Description
1 to 3			For moving to "COM", see steps 1 to 3 in p.277.
4			Press the  /  keys to select "DELIMI" and press the  key.
5			Select the delimiter. The current setting value is displayed on the sub-display. Press  /  key to enter editing mode and the sub-display blinks. Select the delimiter, and press the  key.
6			Press and hold the  key for two seconds to enter the RUN mode.

APPENDICES

10-1 Specifications and External Dimensions.....	282
10-2 Firmware update.....	304
10-3 Processing Item Data List.....	308
10-4 System data list.....	313

10-1 Specifications and External Dimensions

Sensor Head

Specifications

Item	Specifications						
	ZW-S07	ZW-S20	ZW-S30	ZW-S40	ZW-SR07	ZW-SR20	ZW-SR40
Measurement center distance	7 mm	20 mm	30 mm	40 mm	7 mm	20 mm	40 mm
Measuring range	±0.3 mm	±1 mm	±3 mm	±6 mm	±0.3 mm	±1 mm	±6 mm
Static resolution *1	0.01 μm	0.02 μm	0.06 μm	0.08 μm	0.01 μm	0.02 μm	0.08 μm
Linearity *2	±0.8 μm	±1.2 μm	±4.5 μm	±7.0 μm	±1.1 μm	±1.6 μm	±9.3 μm
Spot diameter *3	Near	20 μm dia.	45 μm dia.	70 μm dia.	90 μm dia.	20 μm dia.	45 μm dia.
	Center	18 μm dia.	40 μm dia.	60 μm dia.	80 μm dia.	18 μm dia.	40 μm dia.
	Far	20 μm dia.	45 μm dia.	70 μm dia.	90 μm dia.	20 μm dia.	45 μm dia.
Measuring cycle	500 μs to 10 ms						
Operating ambient illumination	Illumination on object surface of 10000 lx or less (incandescent light)						
Ambient temperature range	Operation: 0 to +50°C, Storage: -15 to +60°C (No freezing and condensation)						
Ambient humidity range	Operation/storage: 35 or 85% (No condensation)						
Degree of protection	IP40 (IEC60529)						
Vibration resistance (destructive)	10 to 150 Hz (half amplitude 0.35 mm), 80 mins in each of X/Y/Z directions						
Shock resistance (destructive)	150 m/s ² , 6 direction, 3 times each (up/down, left/right, forward/backward)						
Temperature characteristic *4	0.6 μm/°C (0.45 μm/°C)	1.5 μm/°C (1.0 μm/°C)	2.8 μm/°C (2.0 μm/°C)	4.8 μm/°C (3.8 μm/°C)	0.6 μm/°C (0.45 μm/°C)	1.5 μm/°C (1.0 μm/°C)	4.8 μm/°C (3.8 μm/°C)
Material	Chassis: aluminum die cast Fiber cable sheath: PVC Calibration ROM: PC						
Fiber cable length	0.3 m, 2 m (flex-resistant cable)						
Fiber cable minimum bend radius	20 mm						
Insulation resistance (Calibration ROM)	Between case and all terminals: 20 MΩ (by 250 V megger)						
Dielectric strength (Calibration ROM)	Between case and all terminals: 1000 VAC, 50/60 Hz, 1 min						
Weight	Approx. 105 g (chassis, fiber cable total)				Approx. 130 g (chassis, fiber cable total)		
Accessories	Instruction Manual, Calibration ROM fixing screws (M2), Note on Use						

*1: Capacity value when OMRON standard mirror surface target is measured at the measurement center distance as the average of 4,096 times
When connected with the Sensor Controller for the Export Control Trade Ordinance (ZW-CE1□□/ZW-C1□□□), the minimum resolution is 0.25 μm, regardless of the Sensor Head and the number of measurements averaged.

*2: Material setting for the OMRON standard mirror surface target: Error from an ideal straight line when measuring on mirror surface
The reference values for linearity when targets to measure other than the above are as in the table below.

Target to Measure	ZW-S07	ZW-S20	ZW-S30	ZW-S40	ZW-SR07	ZW-SR20	ZW-SR40
Glass	±1.0 μm	±1.2 μm	±4.5 μm	±7.0 μm	±1.1 μm	±1.6 μm	±9.3 μm
SUS BA	±1.2 μm	±1.4 μm	±5.5 μm	±8.5 μm	±1.2 μm	±1.8 μm	±9.3 μm
White ceramic	±1.6 μm	±1.7 μm	±6.4 μm	±9.5 μm	±1.6 μm	±1.9 μm	±11.0 μm

*3: Capacity value defined by 1/e² (13.5%) of the center optical intensity in the measured area

*4: Temperature characteristic at the measurement center distance when fastened with an aluminum jig between the Sensor Head and the target and the Sensor Head and the Sensor Controller are set in the same temperature environment. Figures in parentheses are converted value obtained by subtracting the effect of expansion and contraction of the aluminum jig itself.

External Dimensions

● ZW-S07/S20/S30/S40

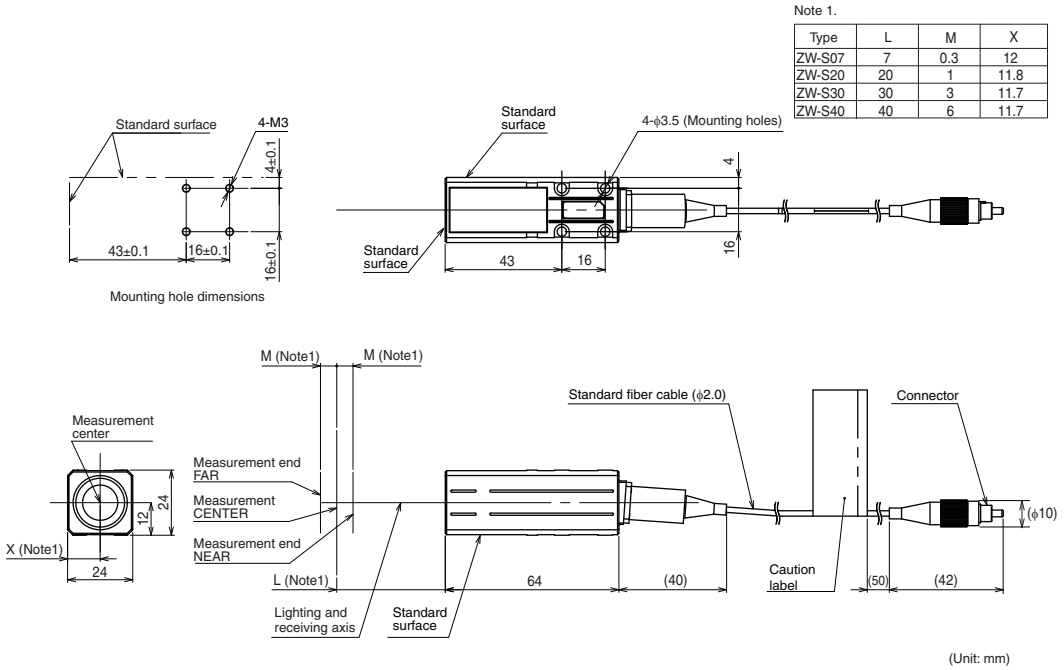

● ZW-SR07/SR20/SR40

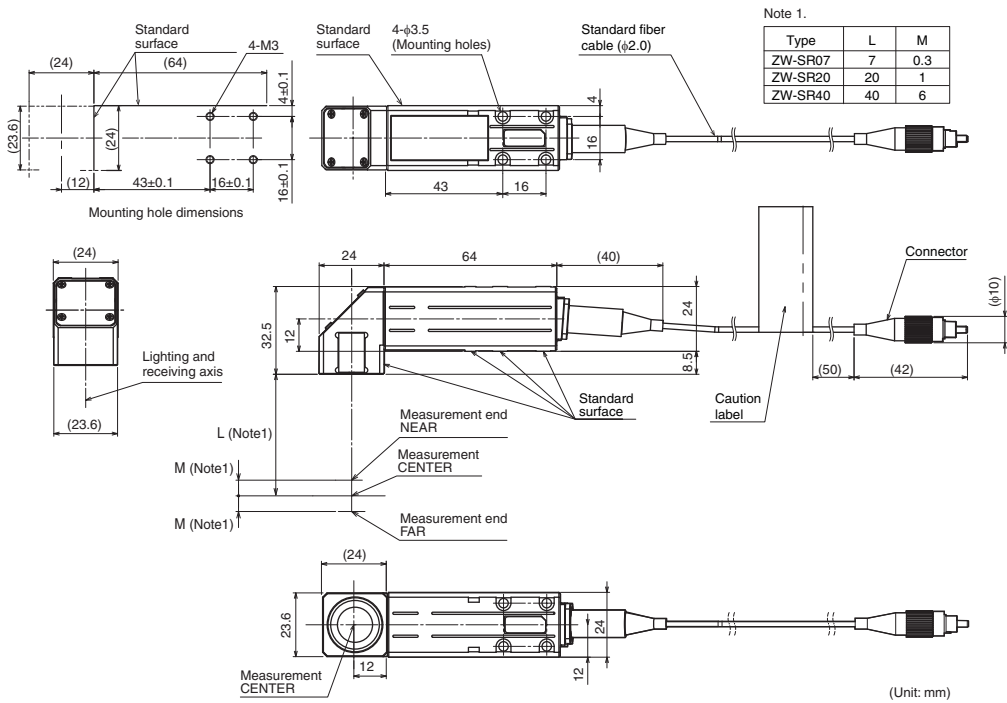

● Calibration ROM (ZW-XROM) *

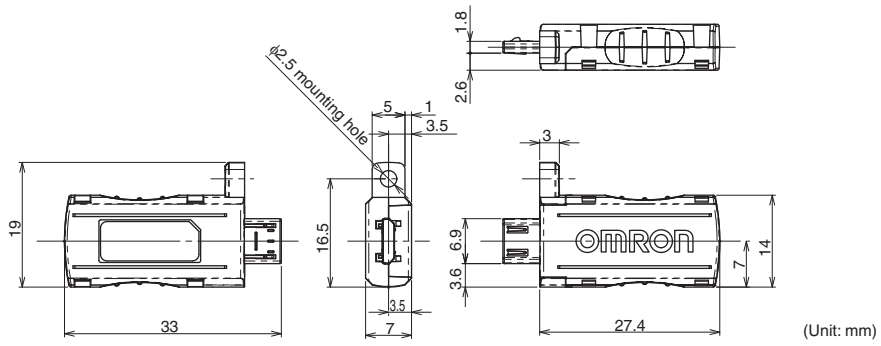

* This comes with the Sensor Head (ZW-S07/S20/S30/S40/SR07/SR20/SR40). Be sure to use a Calibration ROM together with the Sensor Head with the same serial number.

Spot diameter

Spot diameters of ZW-SR07, ZW-SR20, and ZW-SR40 are the same as spot diameters of ZW-S07, ZW-S20, and ZW-S40 respectively.

● ZW-S07

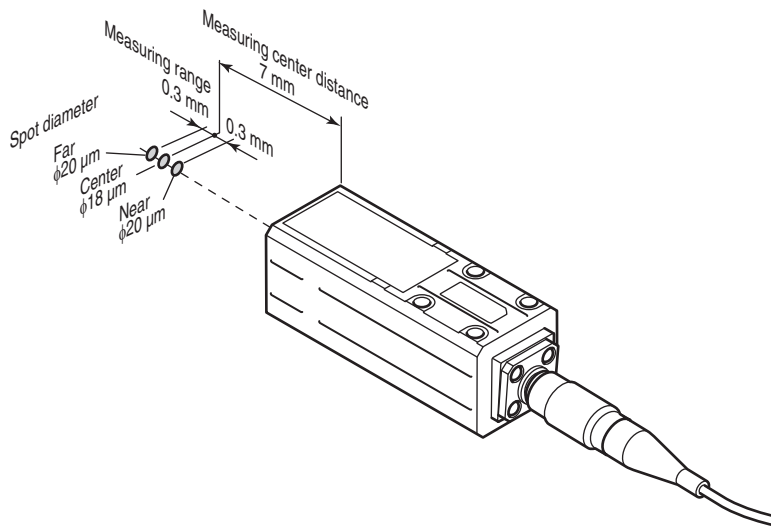

● ZW-S20

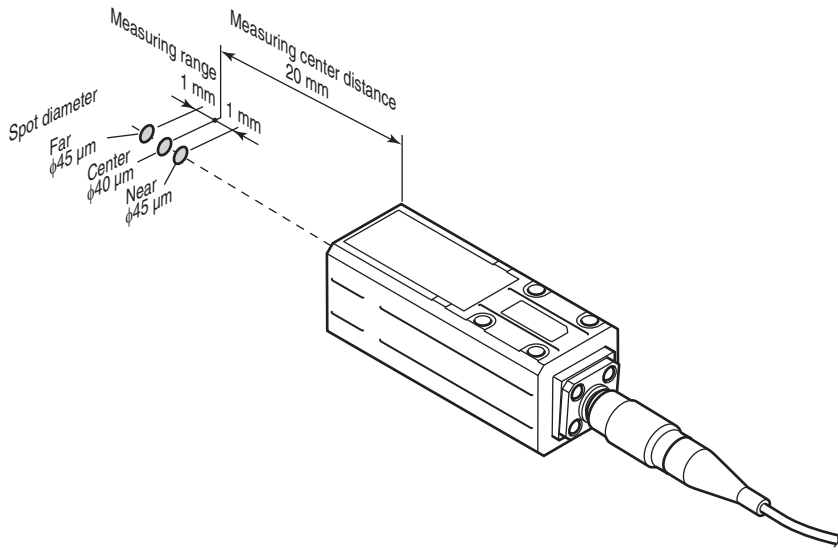

● ZW-S30

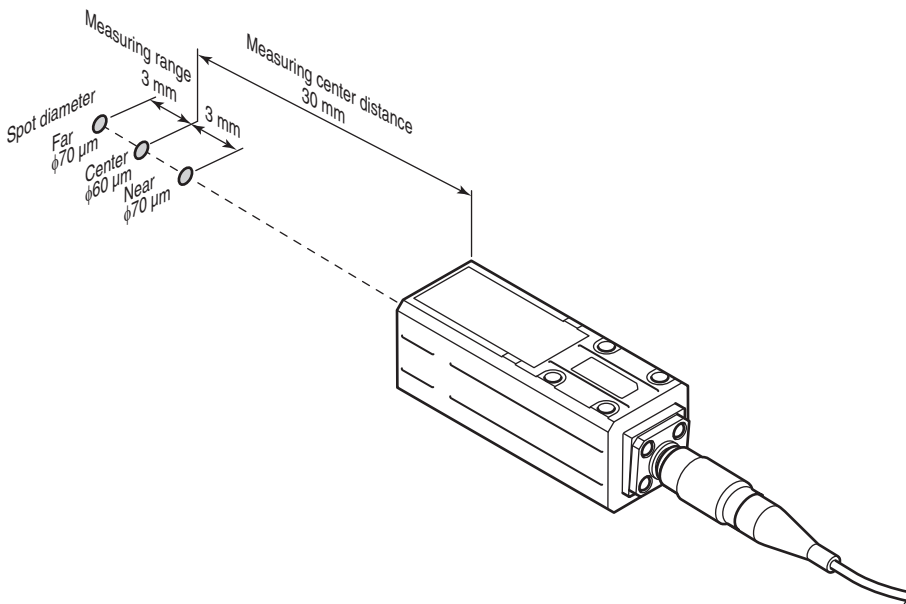

● ZW-S40

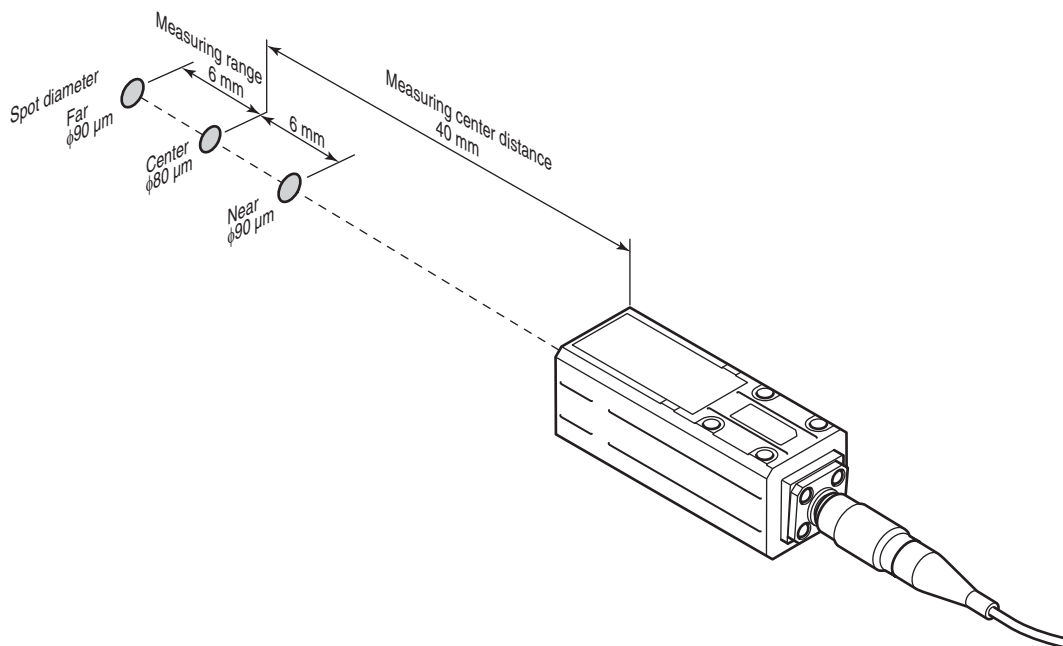

Linearity characteristic by material (typical examples)

Shows the measured distance displayed on the Sensor Controller's main display and the X-axis distance. The measured distance displayed on the main display expresses the measurement center distance as 0 with the near side from the sensor head as + and the far side as -.

● ZW-S07

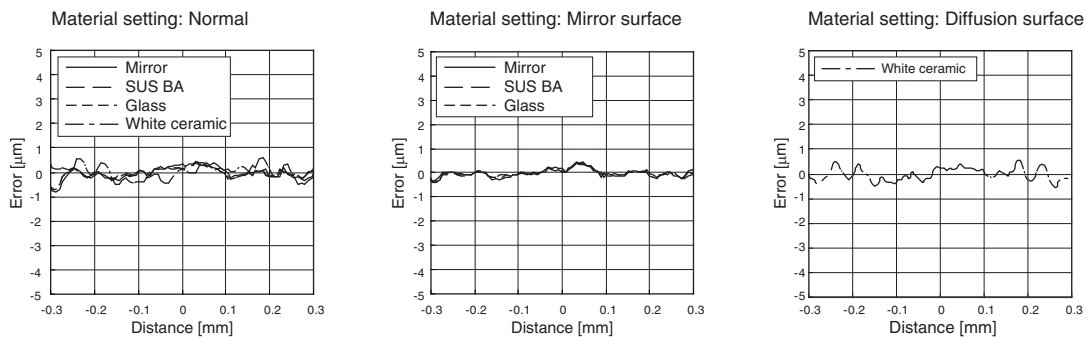

● ZW-S20

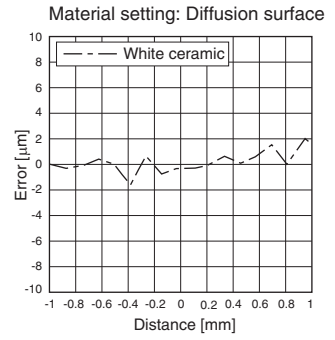
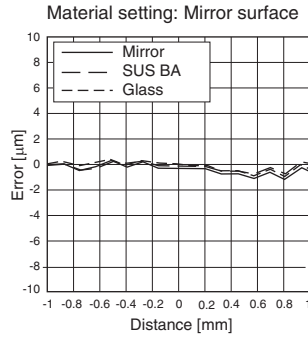
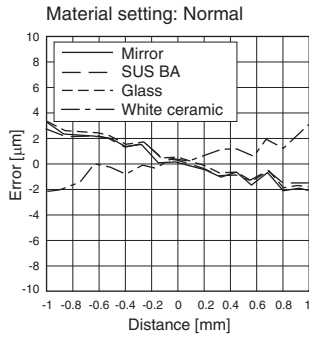

● ZW-S30

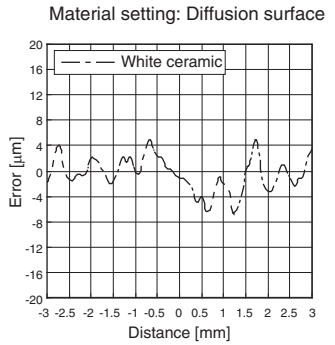
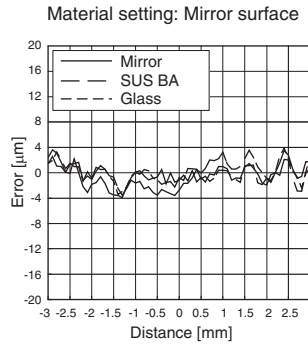
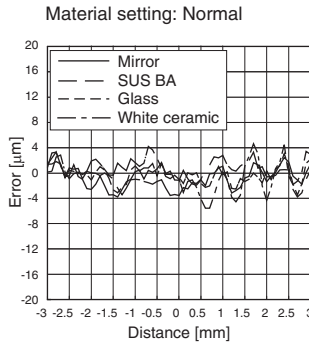

● ZW-S40

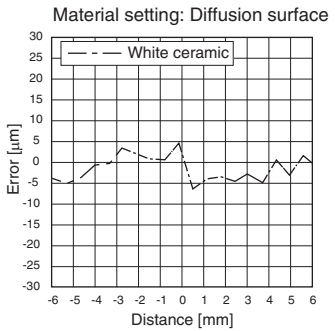
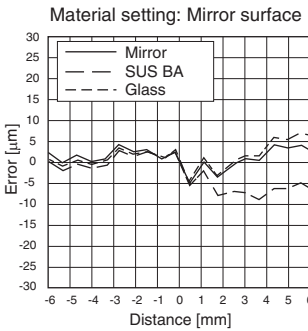
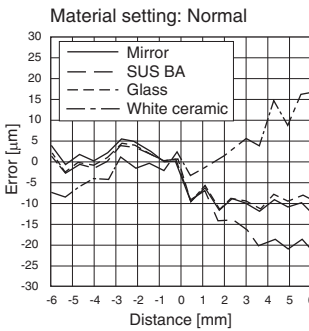

● ZW-SR07

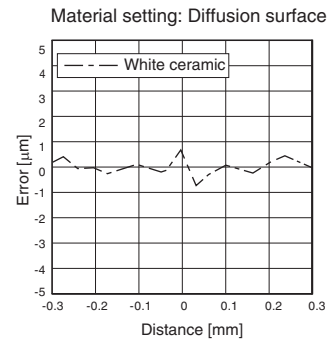
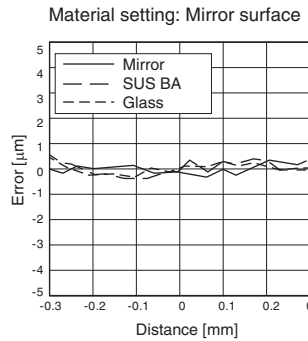
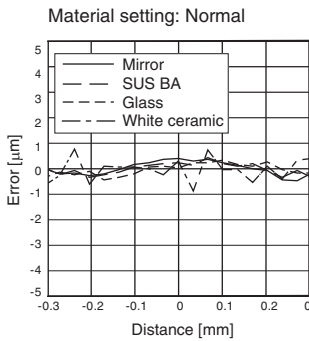

● ZW-SR20

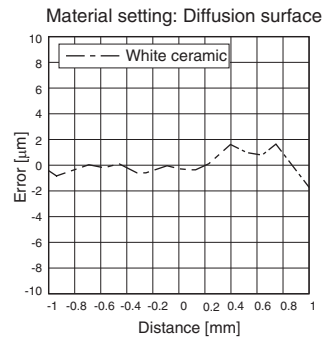
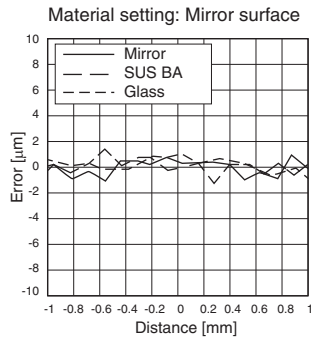
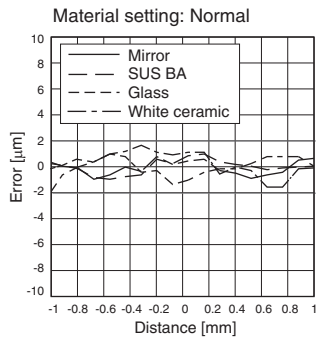

● ZW-SR40

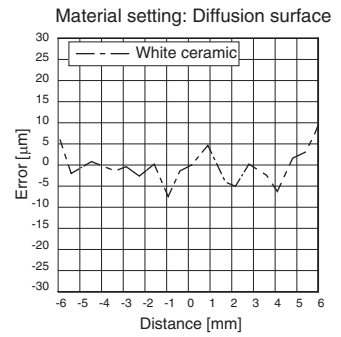
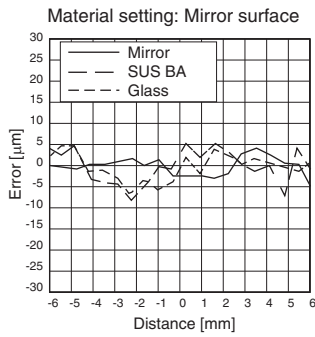
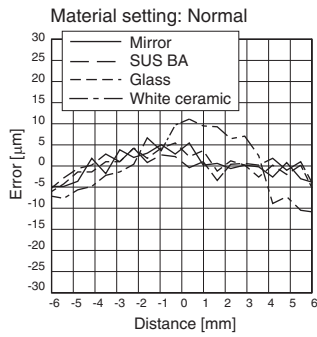

Angle Characteristic (typical examples)

The angle characteristic plots the slope of the target in the measuring range and the maximum value of the error generated in analog output.

Straight type

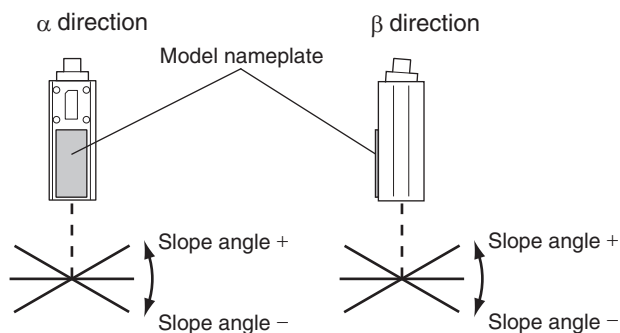

● ZW-S07

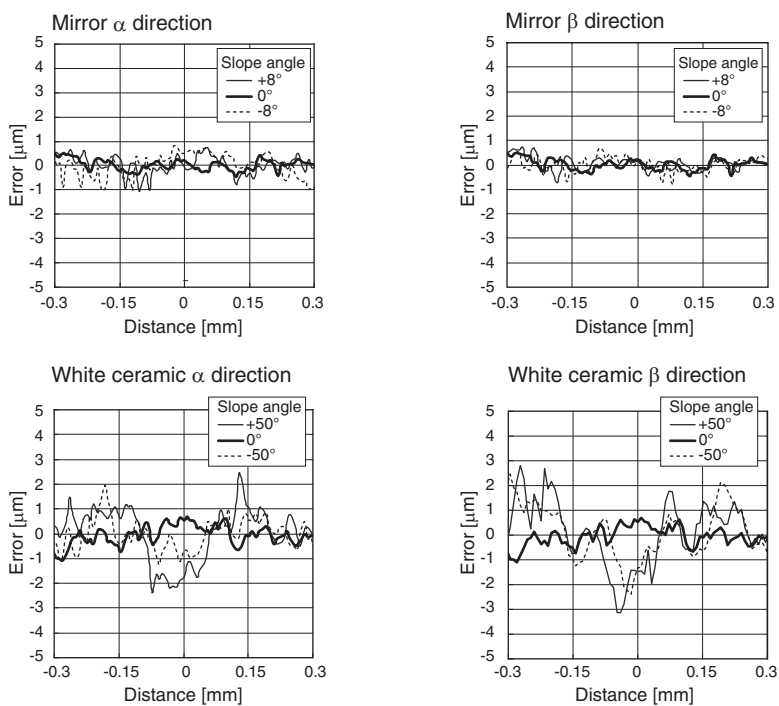

● ZW-S20

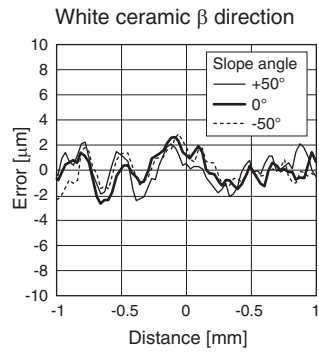
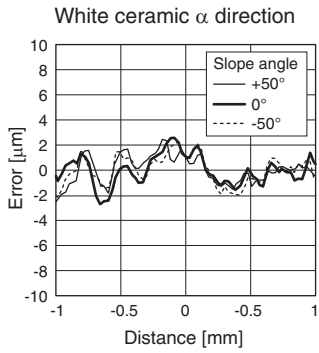
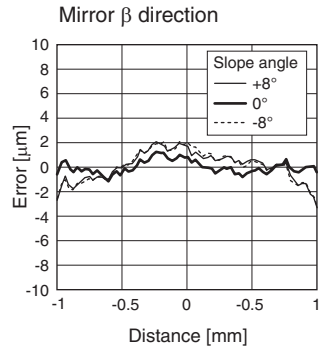
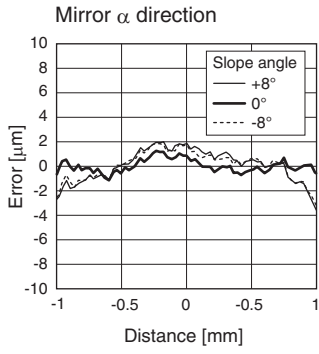

● ZW-S30

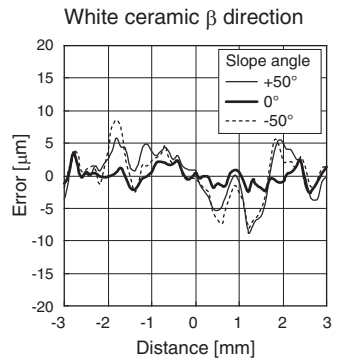
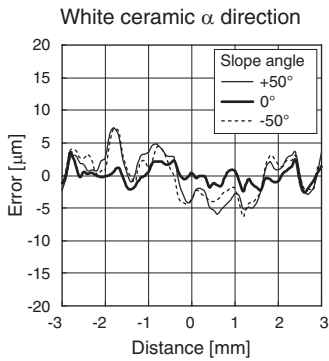
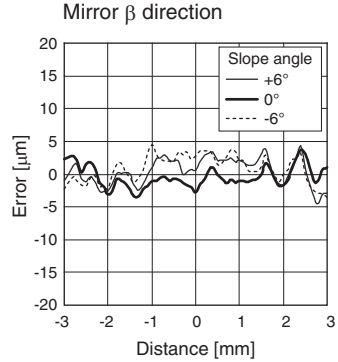
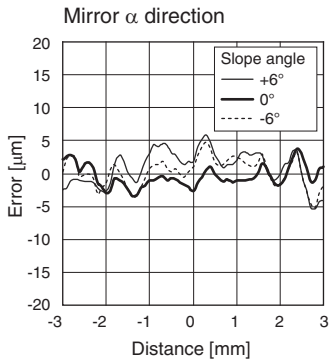

● ZW-S40

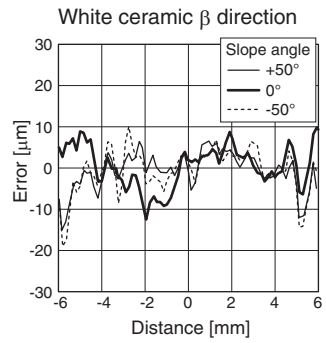
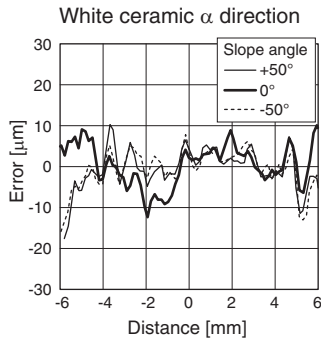
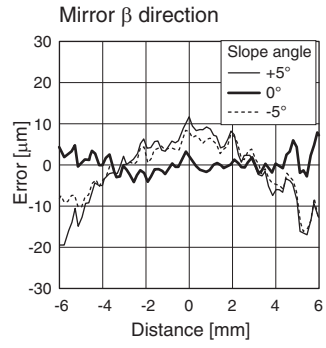
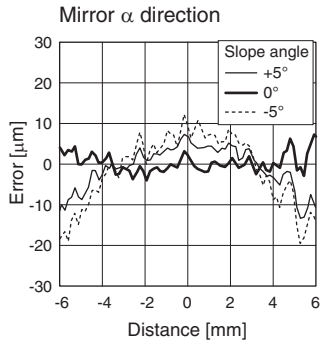

Right angle type

α direction

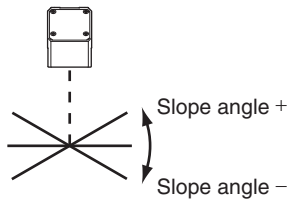

β direction

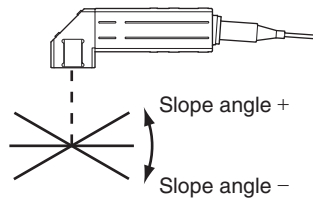

● ZW-S07

Mirror α direction

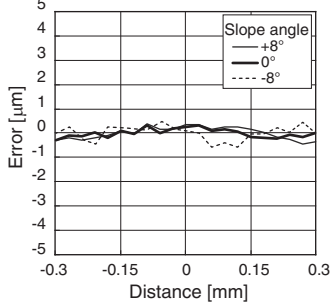

Mirror β direction

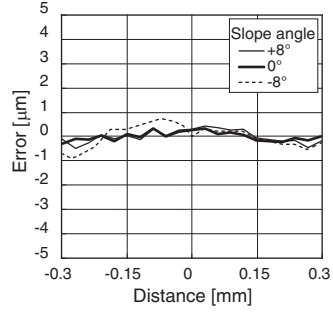

White ceramic α direction

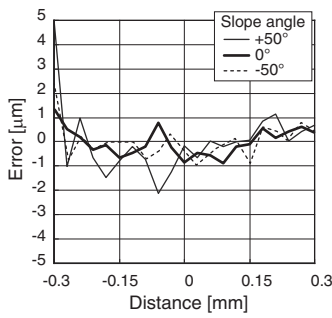

White ceramic β direction

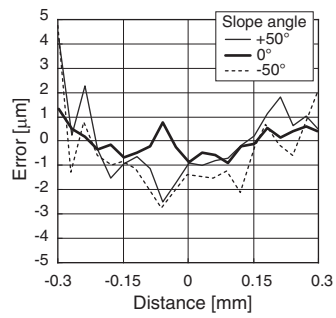

● ZW-SR20

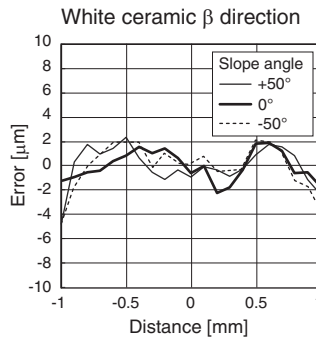
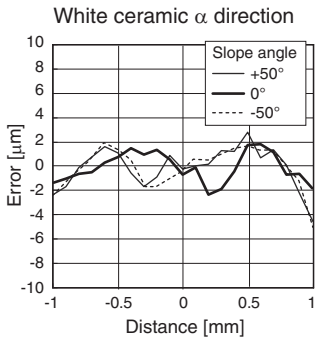
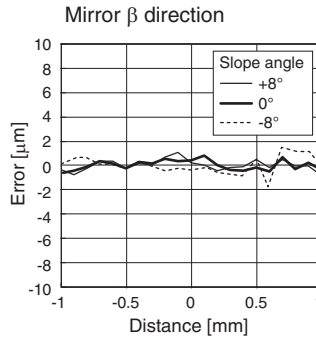
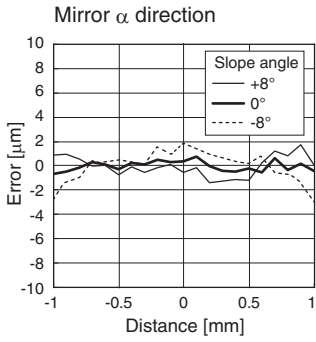

● ZW-SR40

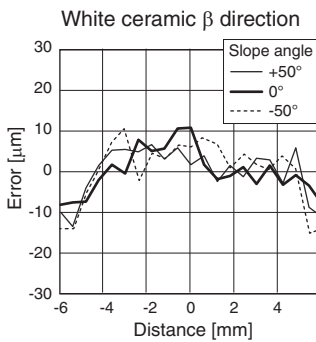
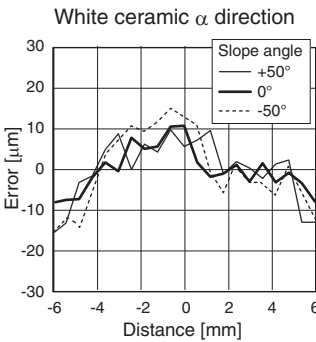
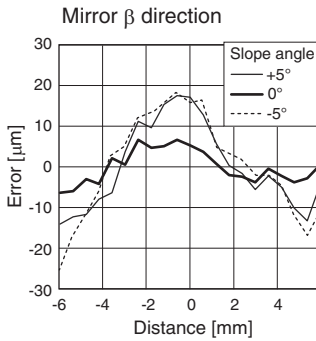
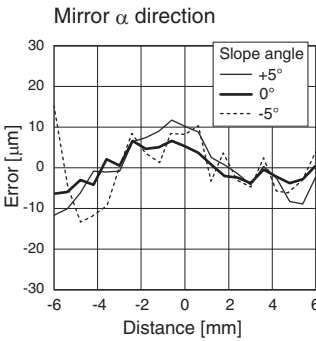

Sensor controller

Specifications

Item		Specifications				
		ZW-C10T	ZW-C10AT	ZW-C15T	ZW-C15AT	
Input/Output type		NPN		PNP		
Number of connected Sensor Heads		1 per Sensor Controller				
Sensor Head compatibility		Available				
Light source for measurement		White LED				
Segment display	Main display	11-segment red display, 6 digits				
	Sub-display	11-segment green display, 6 digits				
LED display	Status indicators	HIGH (orange), PASS (green), LOW (orange), STABILITY (green), ZERO (green), ENABLE (green), THRESHOLD-H (orange), THRESHOLD-L (orange), RUN (green)				
External interface	Ethernet		1 port, 100BASE-TX/10BASE-T			
	RS-232C		1 port, 115,200 bps max.			
	20-pole terminal block	Judgment output (HIGH 1/PASS 1/LOW 1)		Transistor output system Output voltage: 21.6 to 30 VDC Load current: 50 mA or less Residual voltage when turning ON: 1.2 V or less Leakage voltage when turning OFF: 0.1 mA or less		
		BUSY output (BUSY 1)				
		ALARM output (ALARM)				
		ENABLE output (ENABLE 1)				
		Analog voltage output (OUT1V)		-10 to +10 V, Output impedance: 100 Ω		
		Analog current output (OUT1A)		4 to 20 mA, Max. load resistance: 300 Ω		
		LED OFF input (LED OFF 1)		DC input system Input voltage: 24 VDC ± 10% (21.6 to 26.4 VDC) Input current: 7 mA Typ. (24 VDC) ON voltage/ON current: 19 V/3 mA or less ON voltage/ON current: 5 V/1 mA or less		
		ZERO RESET input (ZERO 1)				
		TIMING input (TIMING 1)				
	RESET input (RESET 1)					
	52-pole extension connector	Binary	Measured value output (BINARY 0 to 20)		Transistor output system Output voltage: 21.6 to 30 VDC Load current: 50 mA or less Residual voltage when turning ON: 1.2 V or less Leakage voltage when turning OFF: 0.1 mA or less	
			Gate signal output (GATE)			
Selected task output (BINARY_OUT1/2)						
Selected task input (BINARY_SE L1/2)			DC input system Input voltage: 24 VDC ± 10% (21.6 to 26.4 VDC) Input current: 7 mA Typ. (24 VDC) Voltage/Current when turning ON: 19 V/3 mA or more Voltage/Current when turning OFF: 5 V/1 mA or less			

Item				Specifications			
				ZW-C10T	ZW-C10AT	ZW-C15T	ZW-C15AT
External interface	52-pole extension connector	Bank	Currently selected bank output (BANK_OUT 1 to 3)	Transistor output system Output voltage: 21.6 to 30 VDC Load current: 50 mA or less Residual voltage when turning ON: 1.2 V or less Leakage voltage when turning OFF: 0.1 mA or less			
			Bank Selection input (BANK_SEL 1 to 3)	DC input system Input voltage: 24 VDC $\pm 10\%$ (21.6 to 26.4 VDC) Input current: 7 mA Typ. (24 VDC) ON voltage/ON current: 19 V/3 mA or more OFF voltage/OFF current: 5 V/1 mA or less			
		LOGGING input	DC input system Input voltage: 24 VDC $\pm 10\%$ (21.6 to 26.4 VDC) Input current: 7 mA Typ. (24 VDC) Voltage/Current when turning ON: 19 V/3 mA or more Voltage/Current when turning OFF: 5 V/1 mA or less				
Main functions	Exposure time		Auto/Manual				
	Measuring cycle		500 μ s to 10 ms				
	Material setting		Standard/Mirror/Diffusion surfaces				
	Measurement Item		Height/Thickness/Calculation				
	Filtering		Median/Average/Differentiation/High pass/Low pass/Band pass				
	Outputs		Scaling/Different holds/Zero reset/Logging for a measured value				
	Display		Measured value/Threshold value/Analog output voltage or current value/ Judgment result/Resolution/Exposure time				
	Number of configurable banks		Max. 8 banks				
	Task process		Multi-task (up to 4 tasks per bank)				
	System		Save/Initialization/Display measurement information/Communication settings/Sensor Head calibration/Key-lock/TIMING-key input				
Rating	Power supply voltage		21.6 to 26.4 VDC (including ripple)				
	Current consumption		500 mA max.				
	Insulation resistance		Across all lead wires and Sensor Controller case: 20 M Ω (by 250 V megger)				
	Dialectic strength		Across all lead wires and Sensor Controller case: 1,000 VAC, 50/60 Hz, 1 min				
Environmental immunity	Degree of protection		IP20 (IEC60529)				
	Vibration resistance (destructive)		10 to 55 Hz, 0.35-mm single amplitude, 50 min each in X, Y, and Z directions				
	Shock resistance (destructive)		150 m/s ² , 3 times each in six directions (up/down, left/right, forward/backward)				
	Ambient temperature		Operation: 0 to +40°C Storage: -15 to +60°C (with no icing or condensation)				
	Ambient humidity		Operating and storage: 35 to 85% (with no condensation)				
Grounding		D-type grounding (grounding resistance of 100 Ω or less) Note: For conventional Class D grounding					
Material		Chassis: PC					
Weight		Approx. 750 g (main unit only)					
Accessories		Instruction sheet, Member registration sheet	Instruction sheet, Member registration sheet and software for setting (CD-ROM)	Instruction sheet, Member registration sheet	Instruction sheet, Member registration sheet and software for setting (CD-ROM)		

Status indicators

Mode	Status		Display	Output			Input		RS-232C/ Ethernet
			11-segment display	ANALOG Output	Judgment output (HIGH/PASS/LOW)	Binary output	LED OFF	Zero reset	
RUN	Normal measurement		Measurement result	Output according to measurement result	Judgment result	Output according to the mode (Measurement result/Judgment result)	Enabled	Enabled	Enabled
	Measurement error	KEEP	Previous value						
		CLAMP	"-----"	Output at clamp level	Output OFF	Output of the measured value: clamp level Judgment output: Output OFF	Disabled		
	Measured value not applied		–						
	LED OFF		–						
FUN	–		Display according to menu					Disabled	
System error	–		"SYS.ERR" blinks	Voltage: 0 V output Current: 12 mA output			Disabled	Enabled Commands are accepted but not executed.	
When starting	–		"INIT"	Output at clamp level (approx. -10.8 V)		Output OFF		Invalid (Note)	

Note: Do not obtain data during start-up. The RS-232C output is indeterminate at this time.

External Dimensions

ZW-C10T/C15T/C10AT/C15AT

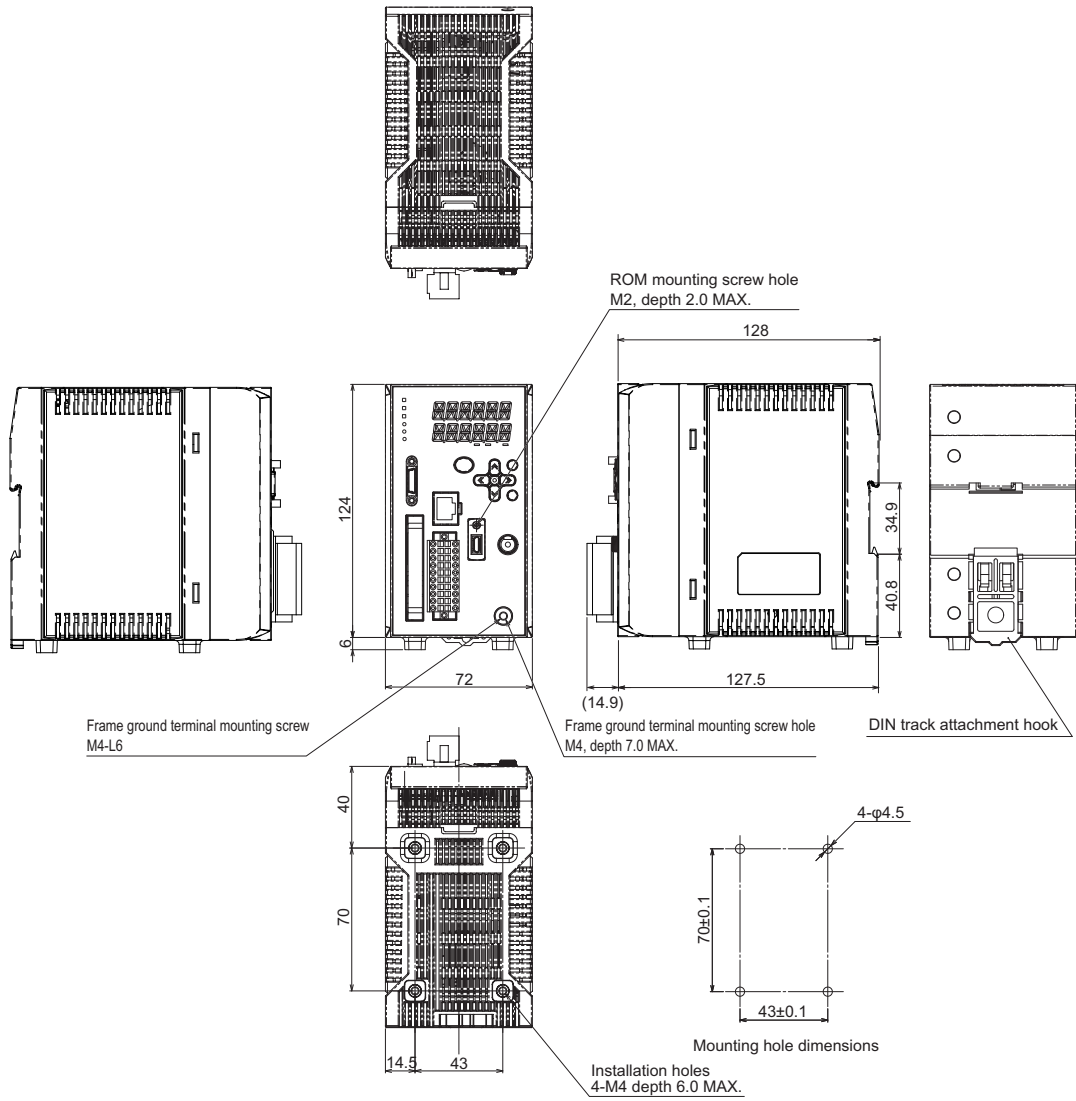

(Unit: mm)

PC tools (Sysmac Studio)

Item	Operating environment
Operating system (OS) ^(*1) Japanese or English	Windows XP (Service Pack3 or later) / Vista (32bit version) / 7 (32bit version/64bit version) / 8 (32bit version/64bit version)
CPU	Windows PC mounted with Celeron 540 (1.8 GHz) or faster chip Core i5 M520 (2.4 GHz) or equivalent or faster product is recommended.
Main memory	2 GB or more
Hard disk	At least 1.6 GB of free space ^(*2)
Display	XGA 1024 × 768, 16,000,000 colors WXGA 1280 × 800 dots or higher resolution is recommended.
Disk drive	DVD-ROM drive
Communication port	USB2.0 compatible USB port or Ethernet port

*1: Note about Sysmac Studio compatible operating systems:
The required system and hard disk capacity differs according to the system environment.

*2: Separate logging memory is required to use the file logging function.

Accessories

Extension fiber cable

ZW-XF02R/XF05R/XF10R/XF20R/XF30R

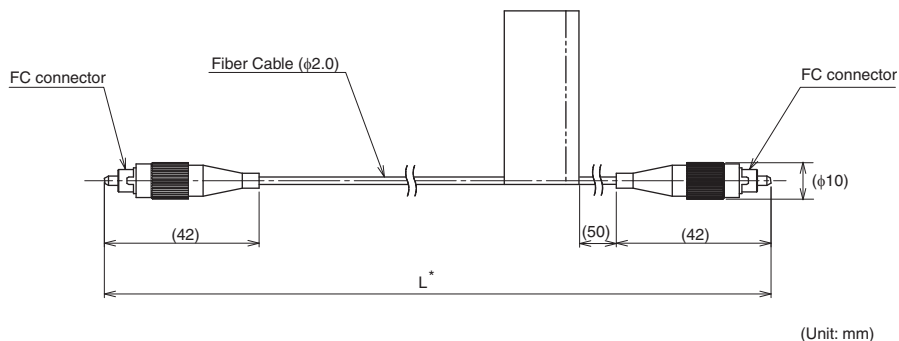

* The following table lists cable lengths per models.

Type	Specification	L (mm)
ZW-XF02R	2m	2000±20
ZW-XF05R	5m	5000±50
ZW-XF10R	10m	10000±100
ZW-XF20R	20m	20000±200
ZW-XF30R	30m	30000±300

Item	Specifications				
	ZW-XF02R	ZW-XF05R	ZW-XF10R	ZW-XF20R	ZW-XF30R
Ambient temperature	Operation: 0 to +50°C, Storage: -15 to +60°C (No condensation)				
Ambient humidity	Operation, storage: 35 to 85%RH (No condensation)				
Vibration resistance (destructive)	10 to 55 Hz (half amplitude 0.35 mm), 50 mins in each of X/Y/Z directions				
Shock resistance (destructive)	150 m/s ² , 6 direction, 3 times each (up/down, left/right, forward/backward)				
Fiber length	2 m	5 m	10 m	20 m	30 m
Material	Cable sheath: PVC, Connector: Bronze				
Fiber cable minimum bending radius	20 mm				
Weight	Approx. 30 g	Approx. 40 g	Approx. 60 g	Approx. 110 g	Approx. 150 g
Accessories	Connection adapter (ZW-XFC), Instruction Manual				

Important

Secure a minimum bending radius (R) for the fiber cable that is at least as large as the specification value. A bending radius smaller than the specification value could cause damage to the fiber cable.

Connection adapter (for connecting fiber cable)

ZW-XFC

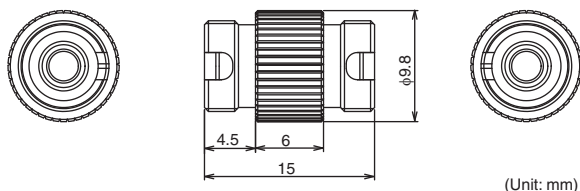

The connection adapter (ZW-XFC) comes packed together with the extension fiber cable (ZW-XF□R), but the connection adapter alone can be purchased for maintenance.

Fiber connector cleaner

ZW-XCL

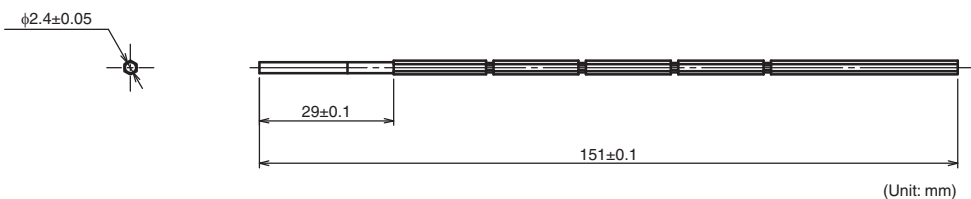

This cleaner can be used only for the following locations:

- Grooves on the fiber connector of the Sensor Controller (C1□T)
- Grooves on the connection adapter (ZW-XFC) supplied with the extension fiber cable (ZW-XF□R)

Take note that this cleaner must not be used to clean the tips of fiber cables.

For cleaning of the tips of fiber cables, refer to "Connecting Fiber Cable" p.34.

Item	Specifications
Applicable item	<ul style="list-style-type: none"> • Grooves on the fiber connector of the Sensor Controller (ZW-C1□T) • Grooves on the connection adapter (ZW-XFC) supplied with the extension fiber cable (ZW-XF□R)
Packed quantity	10 pcs/set
Number of times cleanable	Once
External size	Length 180 mm, ϕ 2.4 mm
Operating ambient temperature range	5 to 35°C
Operating ambient humidity range	40 to 80%
Storage ambient temperature range	5 to 35°C
Storage ambient humidity range	40 to 80%
Material	Nylon plastic, polyolefin plastic, polyester
Weight	20 g
Accessories	Note on use

RS-232C cable

ZW-XPT2 (for PLC/programmable terminal connection)

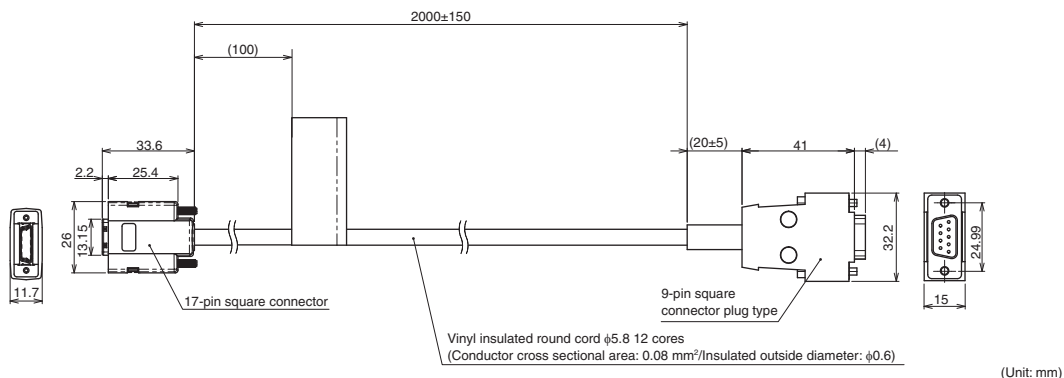

ZW-XRS2 (for PC connection)

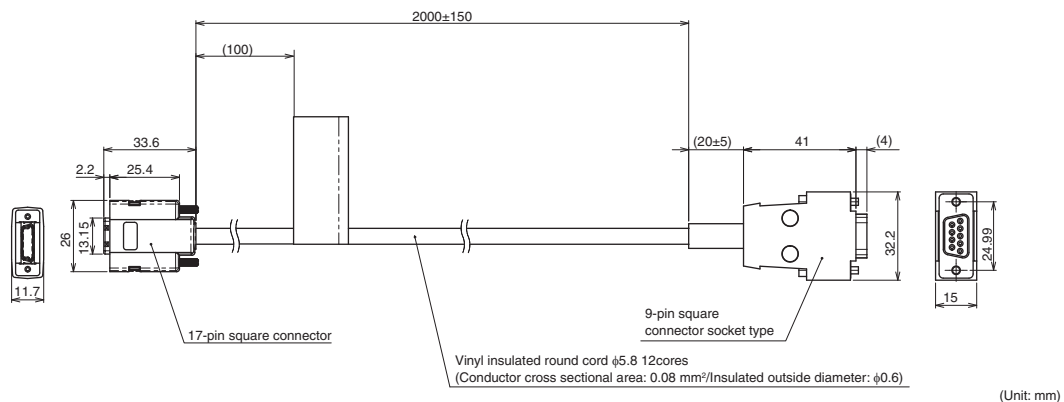

Item	Specifications	
	ZW-XPT2	ZW-XRS2
Applicable Sensor Controller	ZW series	
Ambient temperature	Operation: 0 to +50°C, Storage: -15 to +60°C (No freezing and condensation)	
Ambient humidity	Operation/storage: 35 or 85% RH (No condensation)	
Dielectric strength	1000 VAC, 50/60 Hz, 1 min	
Insulation resistance	20 MΩ (by 250 VDC megger)	
Vibration resistance (destructive)	10 to 55 Hz (half amplitude 0.35 mm), 50 mins in each of X/Y/Z directions	
Shock resistance (destructive)	150 m/s ² , 6 direction, 3 times each (up/down, left/right, forward/backward)	
Material	Cable sheath: PVC	
Cable minimum bending radius	35 mm	
Weight	Approx. 150 g	
Accessories	Instruction Manual	

Important

Secure a minimum bending radius (R) for the cable that is at least as large as the specification value. If the bending radius is smaller than the specification value, this can cause damage to the cable.

Parallel cable

ZW-XCP2

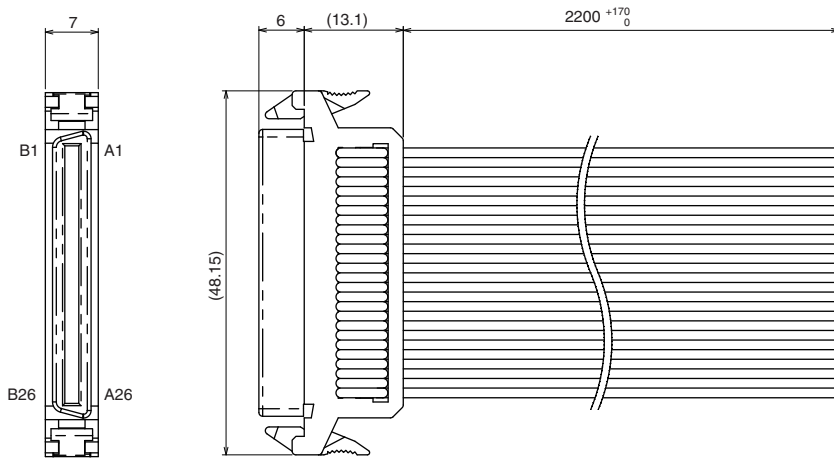

(Unit: mm)

Item	Specifications
Applicable Sensor Controller	ZW-C□□ series
Ambient temperature	Operation: 0 to +50°C, Storage: -15 to +60°C (No freezing and condensation)
Ambient humidity	Operation/storage: 35 or 85% RH (No condensation)
Dielectric strength	1000 VAC, 50/60 Hz, 1 min
Insulation resistance	20 MΩ (by 250 VDC megger)
Vibration resistance (destructive)	10 to 55 Hz (half amplitude 0.35 mm), 50 mins in each of X/Y/Z directions
Shock resistance (destructive)	150 m/s ² , 6 direction, 3 times each (up/down, left/right, forward/backward)
Material	Cable sheath: PVC
Cross section of flat cable	AWG28
Core wire pitch	1.27 mm
Cable minimum bending radius	5.5 mm
Weight	Approx. 240 g
Accessories	Instruction Manual

Important

Secure a minimum bending radius (R) for the cable that is at least as large as the specification value. If the bending radius is smaller than the specification value, this can cause damage to the cable.

EMC Directive Conformity

CE Marking	Applicable directive		Safety category
	Low voltage directive	EMC directive	
Conformed	Not applicable	Conformed	B

10-2 Firmware update

For information on how to obtain the latest version of the firmware, please contact your OMRON sales representative.

After obtaining the latest version of the firmware, follow the procedure below to update the firmware.

Important

Do not turn OFF the power supply to the Sensor Controller during updating. The Sensor Controller would no longer start up properly.

Use PC tools (Sysmac Studio) to update.

- **Explorer pane** : [Device Group] | [(Sensor Name)] (double click)
→ **Edit pane** : [Tools] icon ()

1 Click [Sensor setup] - [Update], and select the update file.

The update file extension is ".BIN". When the file is selected, the [FirmwareWriteInWindow] popup is displayed.

Important

The current firmware version is displayed at [Sensor setup]. Be sure to check the version before updating the firmware.

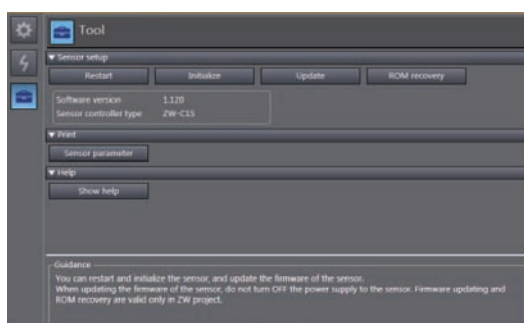

2 Click [Start the update.].

A message to confirm to start the update appears.

Important

When you click [Start the update.], if the "Different format" message is displayed, this means that the format information for the connected Sensor Controller and the specified file do not match. If this happens, never continue with the firmware update. The Sensor Controller breaks down and no longer starts up properly.

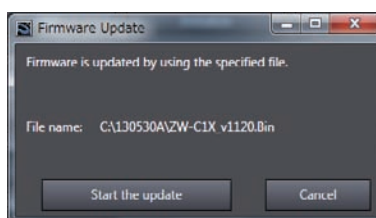

3 Check the content of the message, and click [OK].

The firmware update is started.

A progress bar is displayed during update processing. Wait for the [Firmware Write Completed] popup to be displayed. (The update takes several minutes to complete.)

Important

- Errors may occur on the Sensor Controller during updating, but just wait for the update to complete.
- If the update progress bar stops midway or the update does not end even after ten minutes, there is the possibility that the update has failed. In this case, contact an OMRON branch or sales office about the firmware version before update and the firmware version in the write file.

4 Click [Close].

The firmware update is completed.

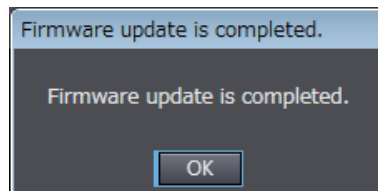

Performing the Update on Warp Engine ZW

Warp Engine ZW is automatically installed when Smart Monitor ZW is installed. For details on the Smart Monitor ZW, refer to the *Smart Monitor ZW Operation manual (Cat. No.Z323)*.

Before proceeding with this operation, connect the ZW to the personal computer where Warp Engine ZW is installed using an Ethernet cable.

Important

- Only start Warp Engine ZW when the computer has recognized the Sensor Controller normally.
- Do not change the IP address and the subnet mask when using Warp Engine ZW on the same personal computer with which SmartMonitor ZW is used. If you are using a different personal computer, refer to p.170 and change the IP address and the subnet mask of the Sensor Controller.

- 1 From the personal computer's Start menu, select [All Programs] - [OMRON] - [ZW] - [Warp Engine ZW].

The [Warp Engine ZW] screen is displayed.



If Warp Engine ZW fails to start up, a message and then the following screen is displayed.

In this case, set the connection port.

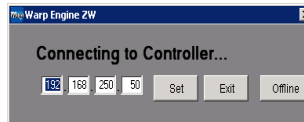

- 2 If necessary, click [Update Controller Information].

The model name and version of the currently connected Sensor Controller are displayed.

- 3 Click [Read Update File], and select the file to write to.

The model name and version of the Sensor Controller held in the file are displayed.

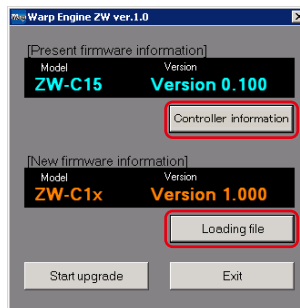

- 4 Click [Start Update].

A message to confirm to start the update appears.

Important

When you click [Start Update], if the "Different format" message is displayed, this means that the format information for the connected Sensor Controller and the specified file do not match. If this happens, never continue with the firmware update. The Sensor Controller breaks down and no longer starts up properly.

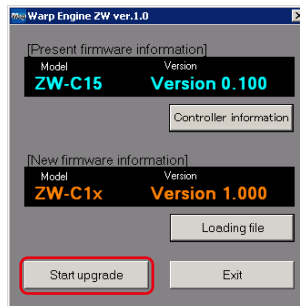

5 Check the content of the message, and click [OK].

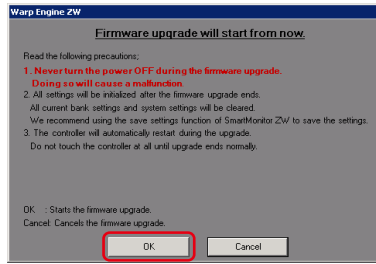

The firmware update is started.

A progress bar is displayed during update processing. Wait for the successful end message box to be displayed. (The update takes several minutes to complete.)



Important

- Errors may occur on the Sensor Controller during updating, but just wait for the update to complete.
- If the update progress bar stops midway or the update does not end even after ten minutes, there is the possibility that the update has failed. In this case, contact an OMRON branch or sales office about the firmware version before the update and the one in the write file.

6 When the update is successfully completed, a message appears. Click [OK].

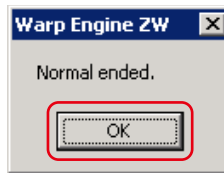

7 Click [Finish] and exit Warp Engine ZW.

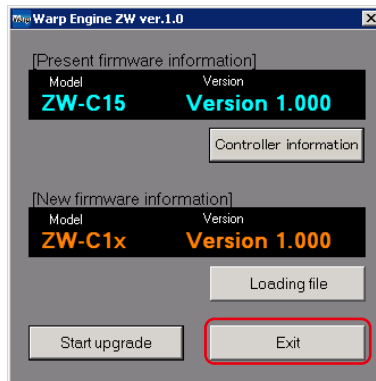

10-3 Processing Item Data List

Unit number	Processing Item	Data number	Parameter	default value	Setting range/output range	Acquisition Yes/No	Setting Yes/No
0	Image input	0	Measuring cycle	2000	500 to 10000 (μ s)	Yes	No
		22	2 area mode	0	0: OFF 1: ON	Yes	Yes
		23	Area tracking mode	0	0: Tracking OFF 1: Start point tracking 2: End point tracking 3: End point/start point tracking	Yes	Yes
		30	Start direction of count measurement surfaces	0	0: NEAR 1: FAR	Yes	Yes
		39	Surface subject to area tracking (Reference surface)	0	0: SUR.1ST 1: SUR.2ND 2: SUR.3RD 3: SUR.4TH 4: LIGHT PEAK	Yes	Yes
		40	Surface subject to area tracking (Tracking surface)	1	0: SUR.1ST 1: SUR.2ND 2: SUR.3RD 3: SUR.4TH 4: LIGHT PEAK	Yes	Yes
		193	2 area teaching	-	1: Execute	No	Yes
1 (Note 1)	Exposure time control (When 2 area mode is OFF)	0	Exposure time control mode	0	0: Auto 1: Fixed	Yes	Yes
		2	Surface subject to exposure time control	4	0: SUR.1ST 1: SUR.2ND 2: SUR.3RD 3: SUR.4TH 4: LIGHT PEAK	Yes	Yes
		6	Exposure time fixed value	1000	1 to 5000 (μ s)	Yes	Yes
		14	Exposure time upper limit	1000	1 to 5000 (μ s)	Yes	Yes
		36	Exposure time	1000	1 to 5000 (μ s)	Yes	No
		37	Received light amount (1 surface)	-	0 to 4095 (Gradation)	Yes	No
		38	Received light amount (2 surfaces)	-	0 to 4095 (Gradation)	Yes	No
		39	Received light amount (3 surfaces)	-	0 to 4095 (Gradation)	Yes	No
20	Measurement object	1	Material	0	0: Normal 1: Mirror surface 2: Diffusion surface	Yes	Yes
		4	Background removal level	100	0 to 4095 (Gradation)	Yes	Yes

(Note 1) When using exposure time control with 2 area mode ON,

Area 1 exposure time control: Unit number "4"

Area 2 exposure time control: Unit number "5"

Unit number	Processing Item	Data number	Parameter	default value	Setting range/output range	Acquisition Yes/No	Setting Yes/No
40	Measurement point	0	MEASUREMENT ITEM	1: TASK 1 0: TASK 2 to 3	0: None 1: Height 2: Thickness of transparent object 3: Calculation	Yes	Yes
		1	Measurement surface 1	4	0: SUR.1ST 1: SUR.2ND 2: SUR.3RD 3: SUR.4TH 4: LIGHT PEAK	Yes	Yes
		2	Measurement surface 2	4	0: SUR.1ST 1: SUR.2ND 2: SUR.3RD 3: SUR.4TH 4: LIGHT PEAK	Yes	Yes
		3	Calculation parameter X	0	0: None 1: TASK 1 2: TASK 2 3: TASK 3 4: TASK 4	Yes	Yes
		4	Calculation parameter Y	0	0: None 1: TASK 1 2: TASK 2 3: TASK 3 4: TASK 4	Yes	Yes
		5	Calculation parameter K	0	-999999999 to 999999999	Yes	Yes
		6	Calculation parameter m	0	-100 to 100 (1 div: 0.1)	Yes	Yes
		7	Calculation parameter n	0	-100 to 100 (1 div: 0.1)	Yes	Yes
		13	Measurement area	0	0: Area 1 1: Area 2	Yes	Yes
41	Scaling	2	Scaling mode	0	0: OFF 1: Height auto 2: Manual 3: Thickness auto	Yes	Yes
		3	Span value	10000	-20000 to 20000 (1 div: 0.1)	Yes	Yes
		4	Offset value	0	-999999999 to 999999999 (nm)	Yes	Yes
42	MEDIAN	2	Median filter mode	0	0: OFF 1: 3 times 2: 9 times 3: 15 times	Yes	Yes
43	AVERAGE	2	Average count	8: 256 times	0: Once 1: Twice 2: 4 times 3: 8 times 4: 16 times 5: 32 times 6: 64 times 7: 128 times 8: 256 times 9: 512 times 10: 1024 times 11: 2048 times 12: 4096 times	Yes	Yes

Unit number	Processing Item	Data number	Parameter	default value	Setting range/output range	Acquisition Yes/No	Setting Yes/No
44	Frequency filter	2	Filter type	0	0: OFF 1: High pass filter 2: Low pass filter 3: Band pass filter	Yes	Yes
		3	Cut-off frequency	1	1 to 999999 (1 div: 0.001)	Yes	Yes
		4	Cut-off frequency (upper)	999999	1 to 999999 (1 div: 0.001)	Yes	Yes
		5	Cut-off frequency (lower)	1	1 to 999999 (1 div: 0.001)	Yes	Yes
45	DIFFERENTIAL	2	Differential mode	0	0: OFF 1: ON	Yes	Yes
		3	Number of differential cycles	1	1 to 5000 (ms)	Yes	Yes
46	Hold	2	Hold mode	0	0: OFF 1: Peak 2: Bottom 3: Peak to peak 4: Auto peak 5: Auto bottom 6: AUTO PEAK TO PEAK 7: Average 8: Sample	Yes	Yes
		3	Trigger method	0	0: External 1: Self-up trigger 2: Self-down trigger	Yes	Yes
		4	Trigger level	0	-999999999 to 999999999 (nm)	Yes	Yes
		5	TRIGGER HYSTERESIS	0.05% of measuring range	0 to 999.999999 (mm)	Yes	Yes
		6	Trigger delay time	1	1 to 5000 (ms)	Yes	Yes
		7	Sampling time	100	1 to 5000 (ms)	Yes	Yes
		8	Trigger delay mode	0	0: OFF 1: ON	Yes	Yes
		47	Zero reset	5	Offset when a zero reset is executed Offset	0	-999999999 to 999999999 (nm)
7	ZERO RESET MODE			0	0: Real 1: Hold	Yes	Yes
64	Zero reset execution enabled/disabled (Status)			1	0: OFF 1: ON	Yes	Yes
49	Judgment output	2	LOW threshold value	-25% of measuring range	-999999999 to 999999999 (nm)	Yes	Yes
		3	HIGH threshold value	+25% of measuring range	-999999999 to 999999999 (nm)	Yes	Yes

Unit numbers 40 to 49 are parameters for the TASK 1 processing unit. To reference the parameters for the processing unit for TASK N, add $20 \times (N - 1)$ to the unit number you want to reference.
(Example)

To change the average processing for TASK 2, reference the parameters for
Processing unit number = $43 + 20 \times (2 - 1) = 63$
Data number = 2

Unit number	Processing Item	Data number	Parameter	default value	Setting range/output range	Acquisition Yes/No	Setting Yes/No
120	Judgment processing	0	Hysteresis width	0.05% of measuring range	0 to 999999999 (nm)	Yes	Yes
		1	Timer mode	0	0: OFF 1: Off delay 2: On delay 3: One shot	Yes	Yes
		2	Delay time	1	1 to 5000 (ms)	Yes	Yes
		3	Task subject to judgment output	0	0: TASK 1 1: TASK 2 2: TASK 3 3: TASK 4	Yes	Yes
121	Non-measurement processing	0	Mode at non-measurement	1	0: Keep 1: Clamp	Yes	Yes
122	Analog output	2	Monitor focus mode	0	0: OFF 1: ON	Yes	Yes
		3	Monitor focus output position 1	- (measuring range)/2	-999999999 to 999999999 (nm)	Yes	Yes
		4	Monitor focus output position 2	+ (measuring range)/2	-999999999 to 999999999 (nm)	Yes	Yes
		5	Monitor focus current lower limit	4	4 to 20 (mA)	Yes	Yes
		6	Monitor focus current upper limit value	20	4 to 20 (mA)	Yes	Yes
		7	Monitor focus voltage lower limit value	-10	-10 to 10 (V)	Yes	Yes
		8	Monitor focus voltage upper limit value	10	-10 to 10 (V)	Yes	Yes
		21	Output object task	1	0: None 1: TASK 1 2: TASK 2 3: TASK 3 4: TASK 4	Yes	Yes
		23	Output level during clamping	0	At current output 0: MAX (approx. 21 mA) 1: 20 mA 2: 19 mA : 16: 5 mA 17: 4 mA 18: MIN (approx. 3 mA) At voltage output 0: MAX (approx. 10.8 V) 1: 10 V 2: 9 V : 20: -9 V 21: -10V 22: MIN (approx. -10.8 V)	Yes	Yes

Unit number	Processing Item	Data number	Parameter	default value	Setting range/output range	Acquisition Yes/No	Setting Yes/No
123	Binary output	8	Output during clamping	0	0: MAX 1: MIN	Yes	Yes
		11	Binary output target	1	0: None 1: Measurement value 1 2: Measurement value 2 3: Judgment value	Yes	Yes
		12	Binary output cycle	1	1 to 100 (cycle)	Yes	Yes
		21	TASK1 specified for data output	0	0: Off 1: On	Yes	Yes
		22	TASK2 specified for data output	0	0: Off 1: On	Yes	Yes
		23	TASK3 specified for data output	0	0: Off 1: On	Yes	Yes
		24	TASK4 specified for data output	0	0: Off 1: On	Yes	Yes
		29	Decimal point digit	5	0: 0 digit 1: 1 digit 2: 2 digit 3: 3 digits 4: 4 digits 5: 5 digits 6: 6 digits	Yes	Yes
		30	GATE period	1	1 to 1000 (1div: 0.1)	Yes	Yes

10-4 System data list

Data number	Parameter	default value	Setting range/output range	Acquisition Yes/No	Setting Yes/No
100	RS-232C data length	1	0: 7 bit 1: 8 bit	Yes	Yes
101	RS-232C parity	0	0: None 1: Off 2: Even	Yes	Yes
102	RS-232C stop bit	0	0: 1 bit 1: 2 bit	Yes	Yes
103	RS-232C baud rate	2	0: 9600 1: 19200 2: 38400 3: 57600 4: 115200	Yes	Yes
104	Flow control	0	0: None 1: ON	Yes	Yes
260	Ethernet protocol	1	0: None 1: TCP server 2: TCP client 3: UDP	Yes	Yes
261	IN port number	9601	0 to 65535	Yes	Yes
262	OUT port number	9601	0 to 65535	Yes	Yes
301	Communications delimiter	0	0: CR 1: LF 2: CR+LF	Yes	Yes
400	Serial data output destination	0	0: OFF 1: Ethernet 2: RS-232C	Yes	Yes
401	Serial data output data format	0	0: ASCII 1: BINARY	Yes	Yes
402	Serial data output number of integer digits	5	1 to 5	Yes	Yes
403	Serial data output number of digits past decimal point	6	0 to 6	Yes	Yes
405	Serial data output field delimiter	0	0: None 1: Comma 2: Tab 3: Space 4: CR 5: LF 6: CR+LF 7: Semi-colon	Yes	Yes
406	Serial data output record delimiter	0	0: None 1: Comma 2: Tab 3: Space 4: CR 5: LF 6: CR+LF 7: Semi-colon	Yes	Yes
407	Serial data output zero suppress	0	0: None 1: ON	Yes	Yes
500	Analog output destination	0	0: Voltage 1: Current	Yes	Yes
600	Bank mode	0	0: Normal 1: Judgment value	Yes	Yes

Data number	Parameter	default value	Setting range/output range	Acquisition Yes/No	Setting Yes/No
601	Current bank number	0	0 to 7: Banks 1 to 8 (start bank number) 0 to 31: Banks 1 to 32 (start judgment value bank number)	Yes	Yes
750	LOGGING save count	12800	0 to 128000	Yes	Yes
750	LOGGING save intervals	1	0 to 1000	Yes	Yes
900	Number of digits displayed past decimal point	1	0 to 5: 0 to 5 digits	Yes	Yes
901	Key lock	0	0: OFF 1: ON	Yes	Yes
902	Timing/reset key input control	0	0: OFF 1: ON	Yes	Yes
1000	Zero reset memory	0	0: OFF 1: ON	Yes	Yes

Index

<hr/>	
Numeric	
20-pole terminal block	25
Terminal functions	40
52-pole expansion connector	25
<hr/>	
A	
Analog output	225
Adjusting output value	141
Assigning	139
Setting monitor focus	140
Analog output terminal block	
Wiring	43
<hr/>	
B	
Bank	59
Bank Settings	
Clearing	109
Copy	107
Saving the Bank/System Settings	108
<hr/>	
C	
Calibration ROM	
Connecting	33
Names of parts	22
Communications command	
Current bank data acquisition command	184
Current bank data setting command	185
Data save command	193
Default gateway acquisition	198
Default gateway setting	198
Head serial information acquisition	201
Internal logging data acquisition command	191
Internal logging data clear command	192
Internal logging data information acquisition command	193
Internal logging start command	190, 191
IP address acquisition	196
IP address setting	196
Judgment result acquisition command	181
MAC address acquisition	201
Measurement command	180
OUT IP address acquisition of the specified socket number	199
OUT IP address setting of the specified socket number	200
Processing unit data acquisition command	182
Processing unit data setting command	183
RESET input command	188
Restart	202
Sensor head calibration command	190
Subnet mask acquisition	197
Subnet mask setting	197

System data acquisition	194
System data setting	195
TIMING input command	188
Version information acquisition command	189
White LED OFF input command	189
Zero reset cancel command	187
Zero reset execution command	186
Connection adapter	36, 300
<hr/>	
D	
Delimiter	173
Digital Displays	221
Alphabetical notation	221
Changing Display Details	226
Changing Threshold Values	227
Entering Numerical Values	223
Positioning decimal point	223
DIN track attachment hook	25, 32, 42
Displayed task	225
Distance	225
<hr/>	
E	
Edit pane	54
Effective bank	225
Electrical Specifications	
Input circuit	46
Output circuit	47
ENABLE indicator	24
Error Messages	
Common	209
Ethernet, Ethernet/IP	208
Ethernet connector	25
Explorer pane	53
Exposure time	225
Extension fiber cable	299
<hr/>	
F	
Fiber cable	
Connect	34
Extend	36
Fiber cleaner	35, 37
Fiber connector cleaner	300
Filters	89
Average Filter	91
Differentiation Filter	93
Frequency Filter	92
Median Filter	90
<hr/>	
H	
HIGH indicator	24
Hold	
Clearing conditions	96
Performing with Key Input	246
Trigger	97
Trigger Delay	100
<hr/>	
I	
Icons	55
Installation hole	25

<hr/>	
J	
Judgment Output	
Assigning	143, 146, 147, 148, 149
Setting Operation at Judgment Output	
	144
Judgment result	225
<hr/>	
L	
LEFT/RIGHT key	24, 220
LOW indicator	24
<hr/>	
M	
Main display	24, 224
Measuring range	27
Mode switching key	24, 220
Multi-task Function	58
<hr/>	
N	
Non-Measurement setting	150
Clamp Value	151, 152
No-protocol	169
<hr/>	
O	
Offline, Debugging	205
Offline, Settings	204
Operating Keys	220
Operation modes	57
<hr/>	
P	
Parallel cable	302
PASS indicator	24
PC tool	21, 298
Project	
Export	66
Import	66
Launching	50
Save	66
<hr/>	
R	
Resolution	225
RS-232C connector	25
RUN indicator	24
<hr/>	
S	
Scaling	83
1-point Scaling	84
2-point Scaling	86
Manual Scaling	83
Thickness Scaling	88
Sensor Controller	
External Dimensions	297
Installing on bottom	33
Installing on the DIN track	32
Names of parts	23
Precautions for installation	31
Specifications	294
Sensor Head	
Angle Characteristic	289
Calibrate	38
External Dimensions	283
Installation	26
Interference	29
Linearity characteristic	286
Measuring range	27

Names of parts	22
Precautions for installation	26
Specifications	282
Spot diameter	284
Setting Exposure Time Control Mode	72,
	73, 74, 75
Setting Measurement Items	79
Calculation	82
Height	79
Thickness	81
Setting the System	110
Sensor Information	110
Setting Threshold Value	64
Direct	64, 259
Teaching	257
Settings for Bank Control	153, 154
Output the currently selected bank	
number	153
Selecting banks	153, 154
STABILITY indicator	24
Sub-display	24
Sysmac Studio Main Window	52
Sysmac Studio Measurement Sensor	
Edition	21
Sysmac Studio, Installing	48
Sysmac Studio, window sections	52
System Configuration	20
<hr/>	
T	
Threshold	225
THRESHOLD-H indicator	24
THRESHOLD-L indicator	24
Timing Chart	
Parallel I/O	155
<hr/>	
U	
UP/DOWN key	220
<hr/>	
Z	
ZERO indicator	24
Zero reset	61, 101
Cancel	63
Execute	62
Offset	102
Type	103
ZERO/SET key	24, 220
ZERORST/ESC key	24, 220

Revision History

A manual revision code appears as a suffix to the catalog number at the bottom of the front and back covers of this manual.

Cat. No. Z322-E1-05

↑
Revision code

Revision code	Date	Revision Contents
01	February 2012	Original production
02	July 2013	Change specifications
03	January 2014	Minor corrections for compatibility with Windows 8
04	August 2014	Addition of Sensor Head, minor corrections
05	August 2015	Additions corresponding to change of EN standard

OMRON Corporation Industrial Automation Company
Kyoto, JAPAN

Contact: www.ia.omron.com

Regional Headquarters

OMRON EUROPE B.V.

Sensor Business Unit

Carl-Benz-Str. 4, D-71154 Nufringen, Germany
Tel: (49) 7032-811-0/Fax: (49) 7032-811-199

OMRON ELECTRONICS LLC

2895 Greenspoint Parkway, Suite 200
Hoffman Estates, IL 60169 U.S.A.
Tel: (1) 847-843-7900/Fax: (1) 847-843-7787

OMRON ASIA PACIFIC PTE. LTD.

No. 438A Alexandra Road # 05-05/08 (Lobby 2),
Alexandra Technopark,
Singapore 119967
Tel: (65) 6835-3011/Fax: (65) 6835-2711

OMRON (CHINA) CO., LTD.

Room 2211, Bank of China Tower,
200 Yin Cheng Zhong Road,
PuDong New Area, Shanghai, 200120, China
Tel: (86) 21-5037-2222/Fax: (86) 21-5037-2200

Authorized Distributor:

© OMRON Corporation 2012 All Rights Reserved.
In the interest of product improvement,
specifications are subject to change without notice.

Cat. No. Z322-E1-05

0815