

SERIES: PBK-1 | **DESCRIPTION:** AC-DC POWER SUPPLY

FEATURES

- up to 1 W continuous output
- compact SIP package
- single regulated outputs from 5~24 V
- 3,000 Vac isolation
- over current and short circuit protections
- CE, UL60950-1 safety approval
- wide input voltage: 70~400 Vdc (85~264 Vac)
- efficiency up to 70%

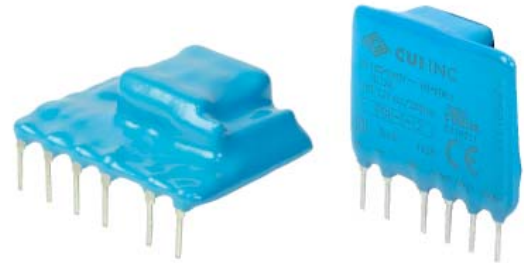

| MODEL | output voltage | output current | output power | ripple and noise ¹ | efficiency |
|----------|----------------|----------------|--------------|-------------------------------|------------|
| | (Vdc) | max (mA) | max (W) | max (mVp-p) | typ (%) |
| PBK-1-5 | 5 | 200 | 1 | 120 | 66 |
| PBK-1-9 | 9 | 111 | 1 | 120 | 67 |
| PBK-1-12 | 12 | 83 | 1 | 120 | 70 |
| PBK-1-15 | 15 | 67 | 1 | 120 | 69 |
| PBK-1-24 | 24 | 42 | 1 | 120 | 68 |

Note: 1. Measured at 20 MHz bandwidth, see Test Configuration section.

PART NUMBER KEY

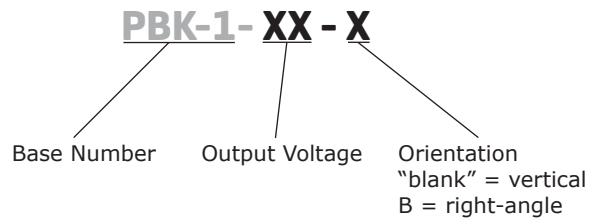

INPUT

| parameter | conditions/description | min | typ | max | units |
|---------------------------|--|-----|-----|-----|-------|
| voltage | | 85 | | 264 | Vac |
| | | 70 | | 400 | Vdc |
| frequency | | 47 | | 440 | Hz |
| current | at 115 Vac | | | 120 | mA |
| | at 230 Vac | | | 40 | mA |
| inrush current | at 115 Vac at 230 Vac | | 10 | | A |
| | | | 20 | | A |
| no load power consumption | | | | 0.5 | W |
| input fuse | 1 A/250 V, slow-blow type (external, required) | | | | |

OUTPUT

| parameter | conditions/description | min | typ | max | units |
|-------------------------|------------------------|-----|-----------|----------|---------|
| output current | | 5 | | | % |
| capacitive load | 5 Vdc output models | | | 220 | μ F |
| | all other models | | | 100 | μ F |
| line regulation | at full load | | ± 1.5 | | % |
| load regulation | at 5%~100% load | | ± 2.5 | | % |
| voltage set accuracy | 5 Vdc output models | | | ± 10 | % |
| | all other models | | | ± 5 | % |
| hold-up time | at 115 Vac | 80 | | | ms |
| | at 230 Vac | 300 | | | ms |
| switching frequency | | | | 50 | kHz |
| temperature coefficient | | | ± 0.1 | | %/°C |

PROTECTIONS

| parameter | conditions/description | min | typ | max | units |
|--------------------------|--------------------------|-----|-----|-----|-------|
| short circuit protection | continuous, auto restart | | | | |
| over current protection | auto restart | | | | |

SAFETY & COMPLIANCE

| parameter | conditions/description | min | typ | max | units |
|------------------------------|---|---------|-----|-----|------------|
| isolation voltage | input to output, for 1 minute | 3,000 | | | Vac |
| isolation resistance | | 100 | | | M Ω |
| safety approvals | UL60950-1, CE | | | | |
| safety class | Class II | | | | |
| conducted emissions | CISPR22/EN55022 external circuit required, Class A (see figure 2); Class B (see figure 3) | | | | |
| radiated emissions | CISPR22/EN55022 external circuit required, Class A (see figure 2); Class B (see figure 3) | | | | |
| ESD | IEC/EN61000-4-2 Class B, contact ± 4 kV | | | | |
| radiated immunity | IEC/EN61000-4-3 Class A, 10V/m (external circuit required, see figure 3) | | | | |
| EFT/burst | IEC/EN61000-4-4 Class B, ± 2 kV (external circuit required, see figure 2) | | | | |
| | IEC/EN61000-4-4 Class B, ± 4 kV (external circuit required, see figure 3) | | | | |
| surge | IEC/EN61000-4-5 Class B, ± 1 kV/ ± 2 kV (external circuit required, see figure 3) | | | | |
| conducted immunity | IEC/EN61000-4-6 Class A, 3 Vr.m.s (external circuit required, see figure 3) | | | | |
| PFM | IEC/EN61000-4-8 Class A, 10 A/m | | | | |
| voltage dips & interruptions | IEC/EN61000-4-11 Class B, 0%-70% | | | | |
| MTBF | at 25°C, max. load | 300,000 | | | hours |
| RoHS | 2011/65/EU | | | | |

ENVIRONMENTAL

| parameter | conditions/description | min | typ | max | units |
|-----------------------|------------------------|-----|-----|-----|-------|
| operating temperature | see derating curves | -40 | | 85 | °C |
| storage temperature | | -40 | | 105 | °C |
| case temperature | | | | 90 | °C |
| humidity | non-condensing | | | 85 | % |

DERATING CURVES

load vs. ambient temperature
(at 110~240 Vac or 100~340 Vdc input voltage)

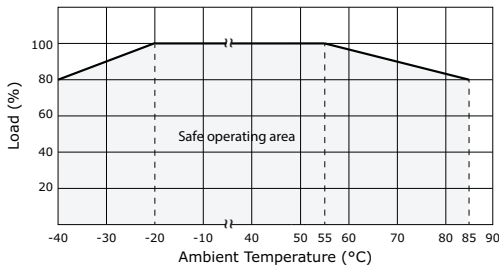

load vs. input voltage (Vac)
(at 25°C)

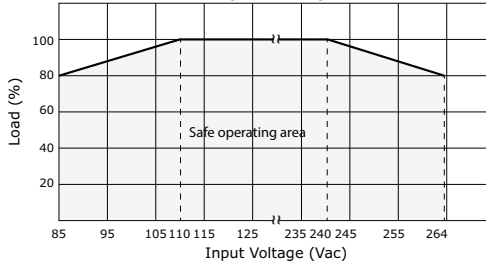

load vs. input voltage (Vdc)
(at 25°C)

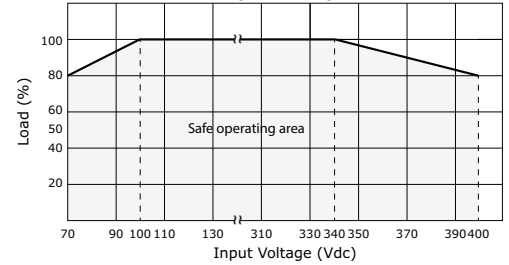

EFFICIENCY CURVES

efficiency vs. load
PBK-1-12

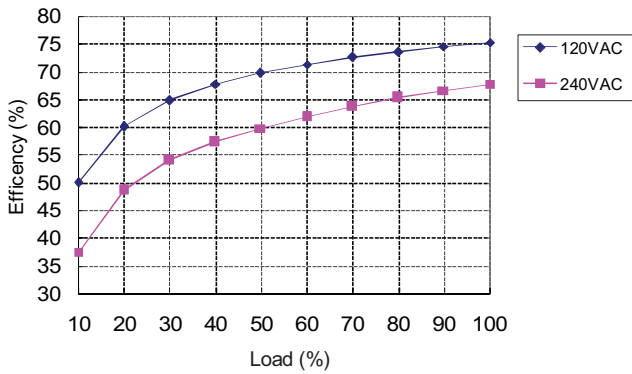

efficiency vs. input voltage (full load)

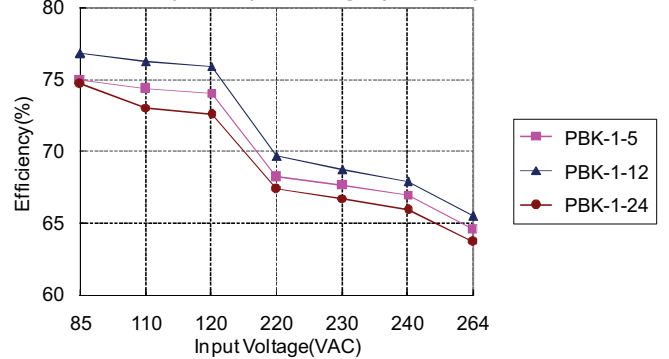

efficiency vs. load
PBK-1-12

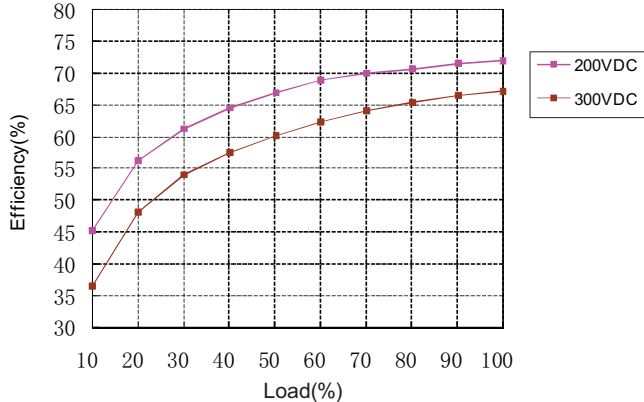

efficiency vs. input voltage (full load)

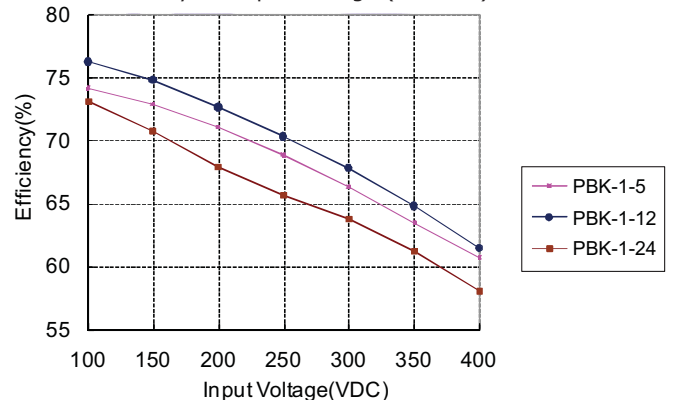

SOLDERABILITY

| parameter | conditions/description | min | typ | max | units |
|----------------|------------------------|-----|-----|-----|-------|
| hand soldering | for 3~5 seconds | 350 | 360 | 370 | °C |
| wave soldering | for 5~10 seconds | 255 | 260 | 265 | °C |

MECHANICAL

| parameter | conditions/description | min | typ | max | units |
|------------|---|-----|-----|-----|----------|
| dimensions | vertical: 35 x 11 x 25 right-angle: 35 x 13 x 25 | | | | mm mm |
| material | UL94V-0 | | | | |
| weight | | | 8 | | g |

MECHANICAL DRAWING

VERTICAL ORIENTATION

units: mm[inch]
tolerance: $\pm 0.5[\pm 0.020]$
pin tolerance: $\pm 0.1[\pm 0.004]$

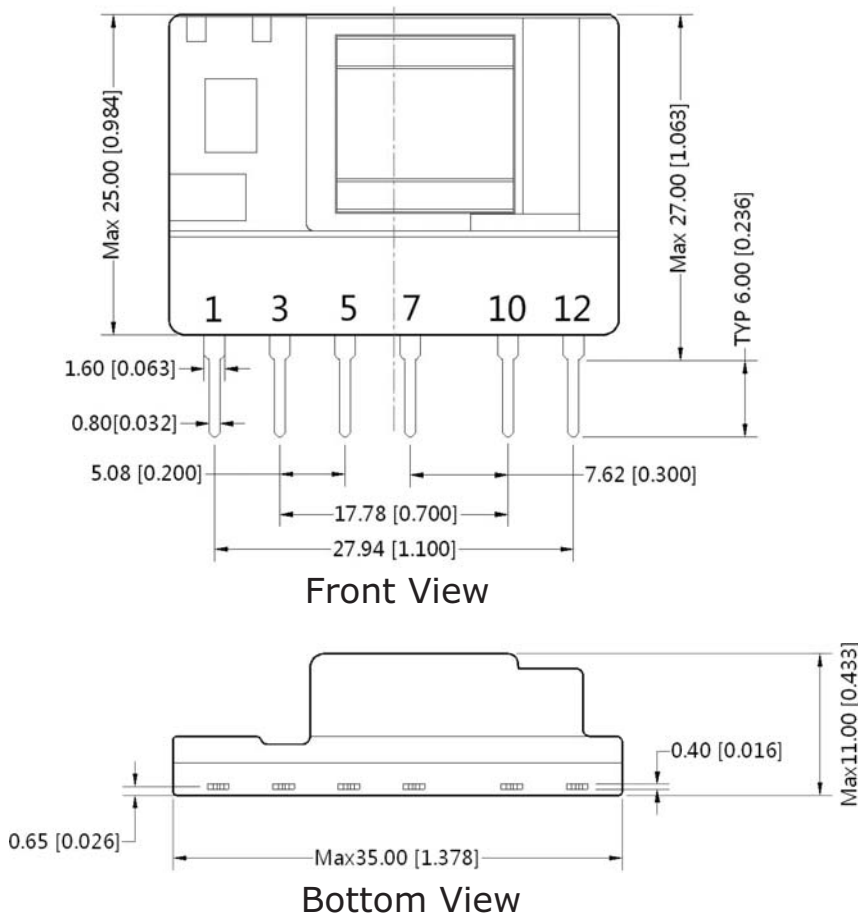

Note: Grid 2.54*2.54mm

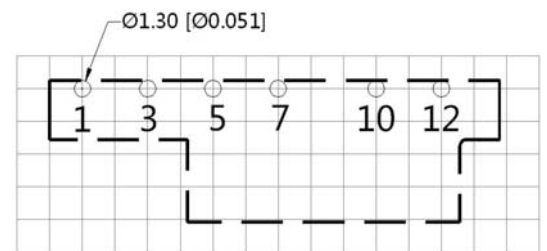

**Top View
PCB Layout**

| PIN CONNECTIONS | |
|-----------------|----------|
| PIN | FUNCTION |
| 1 | -Vin (N) |
| 3 | +Vin (L) |
| 5 | +V(CAP) |
| 7 | -V(CAP) |
| 10 | -Vo |
| 12 | +Vo |

Note: 1. It is required to add C1 between pins 5 & 7 (see application circuits).

MECHANICAL DRAWING (CONTINUED)

RIGHT-ANGLE ORIENTATION

units: mm[inch]
 tolerance: $\pm 0.5[\pm 0.020]$
 pin tolerance: $\pm 0.1[\pm 0.004]$

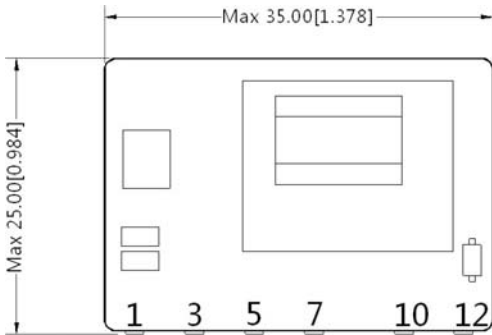

Front View

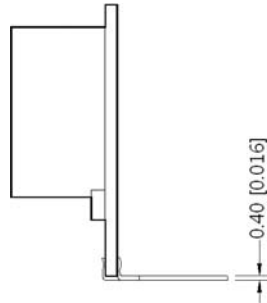

Side View

Note: Grid 2.54*2.54mm

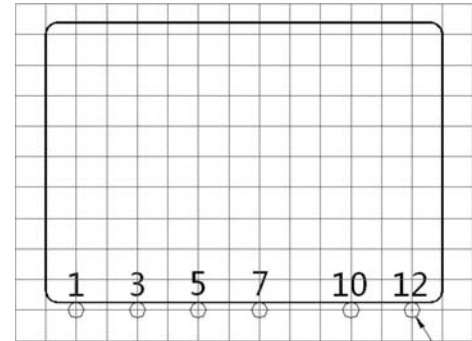

Top View
PCB Layout

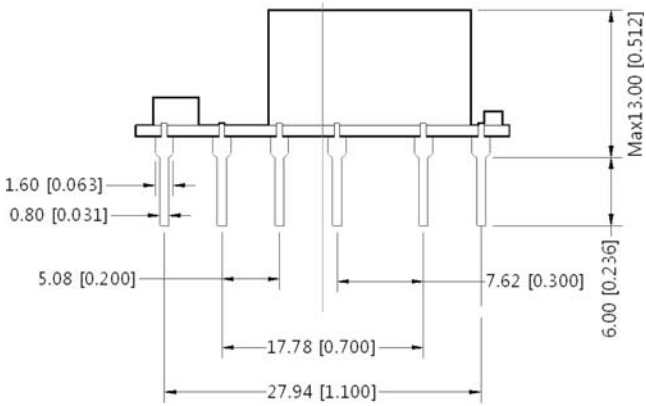

Bottom View

| PIN CONNECTIONS | |
|-----------------|----------|
| PIN | FUNCTION |
| 1 | -Vin (N) |
| 3 | +Vin (L) |
| 5 | +V(CAP) |
| 7 | -V(CAP) |
| 10 | -Vo |
| 12 | +Vo |

Note: 1. It is required to add C1 between pins 5 & 7 (see application circuits).

TEST CONFIGURATION

Figure 1
Connect Oscillograph Probe

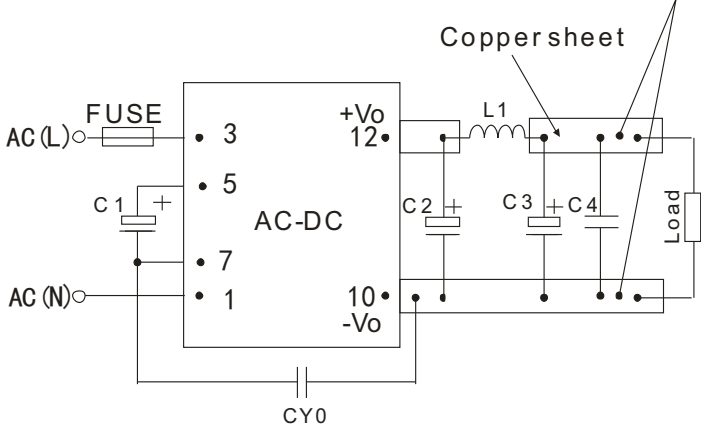

Table 1

| Recommended External Circuit Components | | | | | | |
|---|-----------------|-----------------|-----------------|-----------------|-----------------|--------------------|
| V_{OUT} (Vdc) | C1 ¹ | C2 ¹ | L1 ¹ | C3 ¹ | C4 | CY0 (Y1 capacitor) |
| 5 | 10 μ F/400V | 150 μ F/35V | 2.2 μ H | 68 μ F/35V | 0.1 μ F/50V | 1nF/400Vac |
| 9 | 10 μ F/400V | 150 μ F/35V | 2.2 μ H | 68 μ F/35V | 0.1 μ F/50V | 1nF/400Vac |
| 12 | 10 μ F/400V | 100 μ F/35V | 2.2 μ H | 68 μ F/35V | 0.1 μ F/50V | 1nF/400Vac |
| 15 | 10 μ F/400V | 100 μ F/35V | 2.2 μ H | 68 μ F/35V | 0.1 μ F/50V | 1nF/400Vac |
| 24 | 10 μ F/400V | 100 μ F/35V | 2.2 μ H | 68 μ F/35V | 0.1 μ F/50V | 1nF/400Vac |

Note: 1. Required components.
 2. 1 A/250 V fuse required.

TYPICAL APPLICATION CIRCUIT

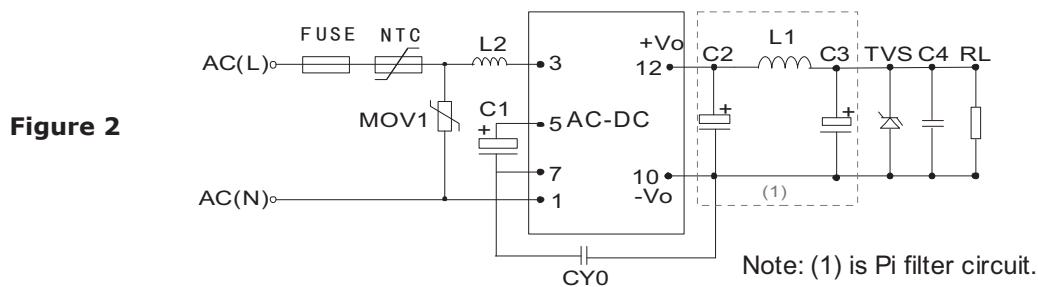

Table 2

| Recommended External Circuit Components | | | | | | | | | | | |
|---|-----------------|-----|-----------------|-----------------|-----------------|-----------------|------------|-------------------|----------|------|---------|
| V_{OUT} (Vdc) | C1 ¹ | L2 | C2 ¹ | L1 ¹ | C3 ¹ | C4 | CY0 | FUSE ¹ | TVS | NTC | MOV1 |
| 5 | 10 μ F/400V | 1mH | 150 μ F/35V | 2.2 μ H | 68 μ F/35V | 0.1 μ F/50V | 1nF/400Vac | 1A/250V | SMBJ7.0A | 5D-9 | S14K350 |
| 9 | 10 μ F/400V | 1mH | 150 μ F/35V | 2.2 μ H | 68 μ F/35V | 0.1 μ F/50V | 1nF/400Vac | 1A/250V | SMBJ12A | 5D-9 | S14K350 |
| 12 | 10 μ F/400V | 1mH | 100 μ F/35V | 2.2 μ H | 68 μ F/35V | 0.1 μ F/50V | 1nF/400Vac | 1A/250V | SMBJ20A | 5D-9 | S14K350 |
| 15 | 10 μ F/400V | 1mH | 100 μ F/35V | 2.2 μ H | 68 μ F/35V | 0.1 μ F/50V | 1nF/400Vac | 1A/250V | SMBJ20A | 5D-9 | S14K350 |
| 24 | 10 μ F/400V | 1mH | 100 μ F/35V | 2.2 μ H | 68 μ F/35V | 0.1 μ F/50V | 1nF/400Vac | 1A/250V | SMBJ30A | 5D-9 | S14K350 |

Note: 1. Required components.

EMC RECOMMENDED CIRCUIT

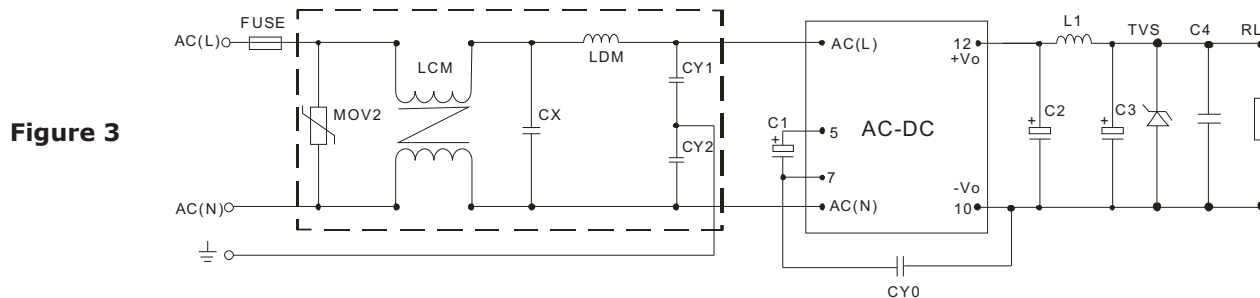

Table 3

| Recommended External Circuit Components | |
|---|--------------------|
| MOV2 | S10K300 |
| CY1, CY2 | 1nF/400Vac |
| CX | 0.1 μ F/275Vac |
| LCM | 3.5mH |
| LDM | 5mH |
| FUSE | 1A/250V, slow blow |

Note: Also refer to Table 2.

- Notes:
- C1 and C3 are electrolytic capacitors. They are required for both AC input and DC input.
 - For AC input, C1 is used as a filter capacitor. The recommended C1 value is 10 μ F/400 V.
 - For DC input, C1 is used as an EMC filter capacitor. The recommended C1 value is 10 μ F/400V. When the input voltage is above 370VDC, we recommend a 10 μ F/450V capacitor.
 - C2 and C3 are output filter capacitors, we recommend high frequency and low impedance electrolytic capacitors. For capacitance and rated ripple current of capacitors refer to the datasheets provided by the manufacturers, voltage derating of capacitors should be 80% or above.
 - C4 is a ceramic capacitor which is used to filter high frequency noise. C2, C3 and L1 form a pi-type filter circuit. For current of L1 and L2 refer to the datasheets provided by the manufacturers, current derating should be 80% or above. TVS is a recommended component to protect post-circuits (if converter fails). We recommend using a 5D-9 external input NTC.
 - For standard EMC requirements, please refer to figure 2. If a higher EMC is required, please refer to figure 3.
 - All specifications measured at Ta=25C, humidity <75%, 115 Vac & 230 Vac input voltage, and rated output load, unless otherwise specified.

REVISION HISTORY

| rev. | description | date |
|------|---|------------|
| 1.0 | initial release | 08/09/2013 |
| 1.01 | added bent pin model options, updated emc recommendations | 03/25/2014 |

The revision history provided is for informational purposes only and is believed to be accurate.



Headquarters
20050 SW 112th Ave.
Tualatin, OR 97062
800.275.4899

Fax 503.612.2383
cui.com
techsupport@cui.com

CUI offers a two (2) year limited warranty. Complete warranty information is listed on our website.

CUI reserves the right to make changes to the product at any time without notice. Information provided by CUI is believed to be accurate and reliable. However, no responsibility is assumed by CUI for its use, nor for any infringements of patents or other rights of third parties which may result from its use.

CUI products are not authorized or warranted for use as critical components in equipment that requires an extremely high level of reliability. A critical component is any component of a life support device or system whose failure to perform can be reasonably expected to cause the failure of the life support device or system, or to affect its safety or effectiveness.